

Taming linear-regulator inrush currents

By Jeff Falin

Senior Applications Engineer

Many older linear regulators and some regulators specifically designed for fast start-up require significant inrush current at start-up to charge their output capacitors and to provide current to their resistive loads. The relationship $I_{\text{Inrush}} = C_{\text{OUT}} \times V_{\text{OUT}}/t_{\text{Rise}}$ predicts the regulator's required input current at start-up for a given rise time, t_{Rise} , where C_{OUT} is the regulator's output capacitance. With no inrush-control (commonly called "soft-start") circuitry, I_{Inrush} is clamped to the regulator's current limit, which is typically significantly higher than the regulator's rated current. If the input power supply is current-limited or connected by long inductive traces, the voltage at the regulator's input will droop, possibly below that of the regulator's under-voltage lockout (UVLO) circuit. Figure 1 illustrates how this causes the regulator to "stair step" or ratchet its way up to regulation, shutting down momentarily while the input capacitor recharges, then starting up again.

In the past, start-up problems were common for linear regulators and can still occur when the output capacitance seen by the regulator is large. End-equipment designers need to take into account how linear regulators handle inrush current, especially if the selected regulator has no inrush-current control other than clamping to its current limit.

Additional circuitry can be configured to manage inrush current for any regulator or converter. Simply by adding a FET and some passive elements following the regulator's or converter's output voltage, the designer can shape the FET's turn-on characteristic and the output-voltage waveform. For example, a designer has minimal control over

Figure 1. Older regulator with 2.5-V UVLO ratcheting up to regulation with no load

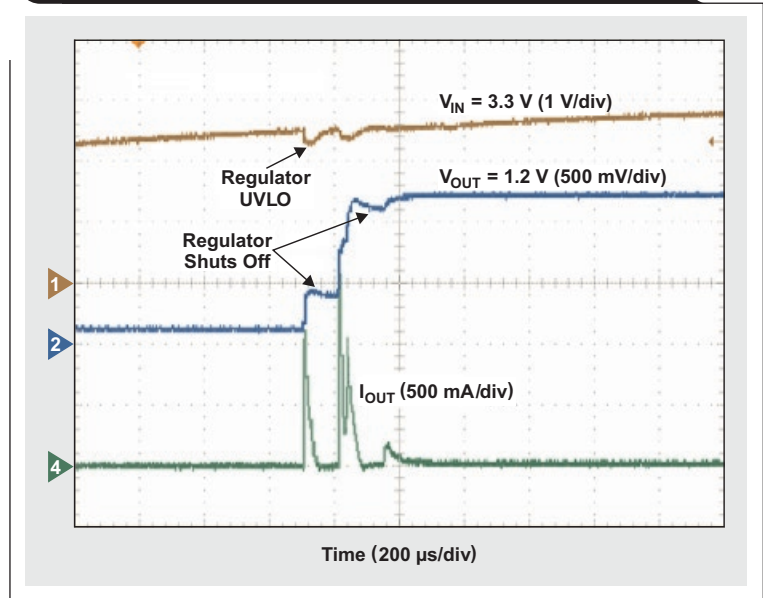

the inrush current of linear regulators designed for fast start-up, like the Texas Instruments (TI) TPS734xx/5xx, which have a high power-supply ripple rejection (PSRR), low noise, and an ultralow I_q . Figure 2 shows how adding a FET and some passive circuitry to the TPS73525 provides greater control over the inrush current. I_{IN} is measured between the regulator input pin and the input capacitor because both the capacitor and the input power supply will supply the inrush current.

Figure 2. FET following the TPS73525 to provide inrush-current control

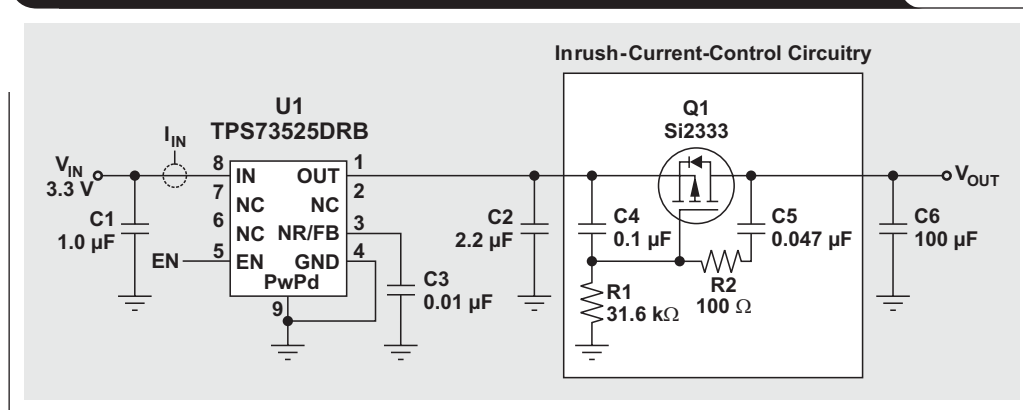

Note that in Figure 3 the amplitude and duration of the initial current spike are significantly reduced compared to those in Figure 4 because the output sees only the 2.2- μF capacitor instead of the 100- μF capacitor. Surprisingly, capacitor C5, providing additional FET gate-to-drain capacitance, and resistor R1 set the soft-start time. Reference 1 explains in detail how the additional circuit works, how to choose the FET, and how to size the passive elements.

Some regulators use a topology that has inherent inrush-current control. For example, the TI TPS732xx/4xx/6xx family of linear regulators has an internal charge pump that is needed to drive the gate of the n-channel pass element. At start-up, the charge pump needs a finite amount of time—several hundred microseconds—to charge the internal servo capacitor, which in turn charges the n-FET's gate capacitance. Figure 5 shows the TPS73633 output

voltage and inrush current at start-up with $C_{\text{OUT}} = 1 \mu\text{F}$ and 10 μF .

Even though these linear regulators have an 800-mA maximum current limit, the inrush current never exceeds 150 mA, after a brief spike to 300 mA, even with a 10- μF output capacitor.

From the relationship $I_{\text{Inrush}} = C_{\text{OUT}} \times V_{\text{OUT}}/t_{\text{Rise}}$, and by comparing the output voltage rise times in Figures 4 and 5, one can see that there is an inverse relationship between the output-voltage ramp time and the inrush current. Therefore, in recent years, IC manufacturers have developed linear regulators with user-controllable V_{OUT} ramp time (soft start), not only to manage inrush current but also to meet the power-rail ramp-time requirements of certain DSPs and FPGAs. The simplest integrated soft-start method, used by the TI TPS74x01 family of regulators, is

Figure 3. TPS73525 starting up into 100 μF without FET

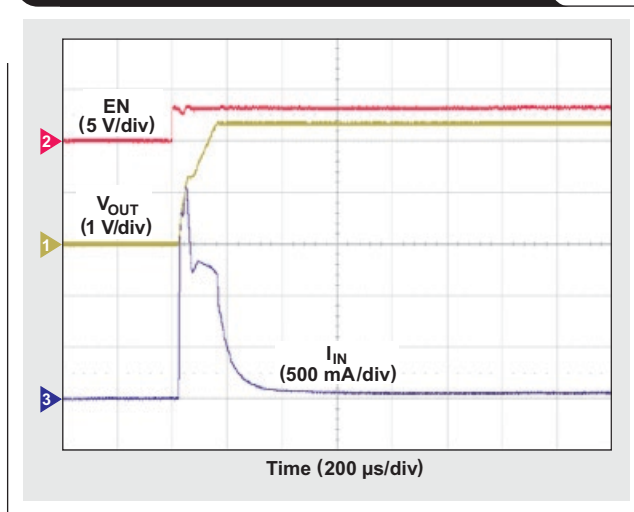

Figure 4. TPS73525 starting up into 100 μF with inrush-current-control FET

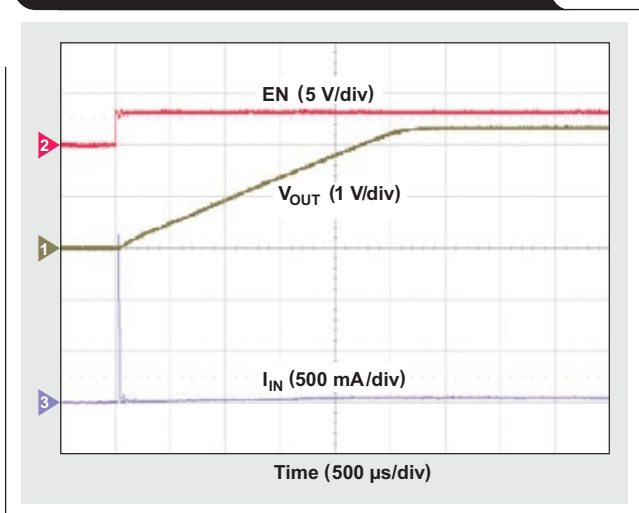

Figure 5. TPS73633 starting up with $C_{\text{OUT}} = 1 \mu\text{F}$ and 10 μF

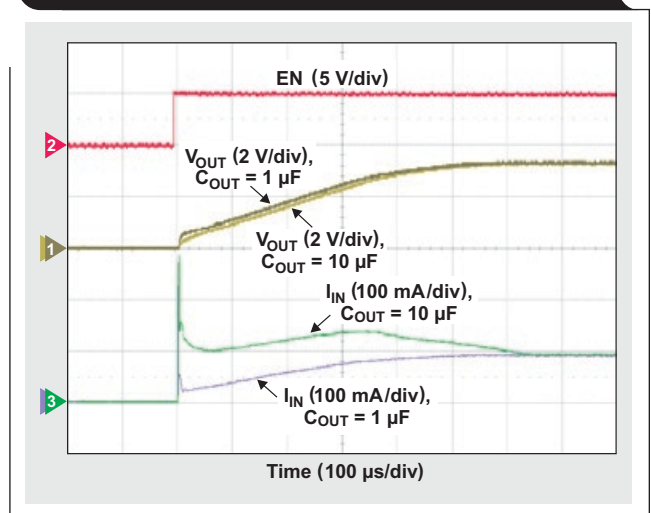
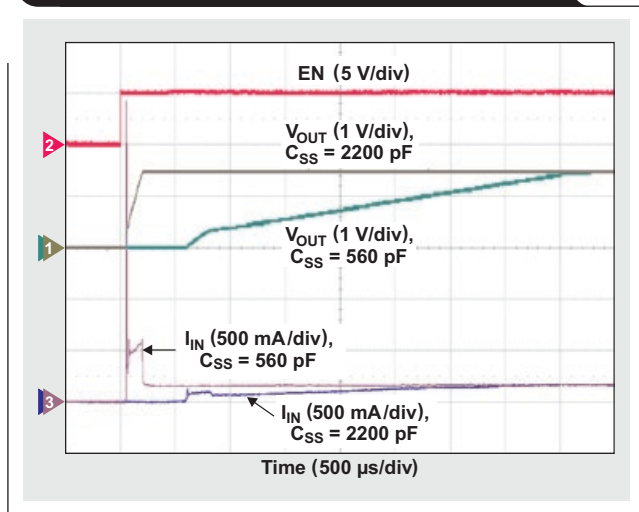

Figure 6. TPS74901 soft starting with $C_{SS} = 560 \text{ pF}$ and 2200 pF , and $C_{OUT} = 10 \text{ }\mu\text{F}$



to slowly ramp the error amplifier's internal reference voltage following an enable signal. The IC uses an external capacitor (C_{SS}) on the soft-start pin and an internal constant-current source (I_{SS}) to linearly charge this capacitor, which is initially tied to the regulator's error amplifier. Once the capacitor is charged to the same value as the internal reference voltage, V_{REF} , the IC switches the error-amplifier connection to the internal reference. Therefore, without affecting regulation, the designer can set the soft-start time as predicted by a simple equation, $t_{SS} = V_{REF} \times C_{SS}/I_{SS}$, by adjusting the capacitor value. Figure 6 shows the TPS74901 output voltage and current at start-up, with two different soft-start capacitors and $C_{OUT} = 10 \text{ }\mu\text{F}$.

This soft-start method is very common and works as predicted for start-up loads that are primarily capacitive and not resistive. When the start-up load has resistive loading, the method still works, but the ramp (soft-start) time is a bit longer than predicted by the t_{SS} equation.

TI's low- I_q , dual-rail, 350-mA TPS720xx linear regulator addresses simultaneous capacitive and resistive loads with a novel, internal architecture that limits inrush current. Instead of being clamped to an overcurrent-limit value as with older regulators, the current drawn from the input to the output is limited to a lower value,

$$I_{\text{Inrush_Limit}} = I_{R_L} + C_{OUT} (\mu\text{F}) \times 0.0455 (\text{V}/\mu\text{s}),$$

where I_{R_L} is the start-up resistive loading. Figure 7 shows the TPS72015 starting up at different fixed resistive loads with $C_{OUT} = 2.2 \text{ }\mu\text{F}$ and $10 \text{ }\mu\text{F}$. The soft-start circuitry scales the soft-start current proportionally with C_{OUT} so that the start-up time is virtually independent of C_{OUT} .

Figure 7. TPS72015 starting up at different loads (R_L)

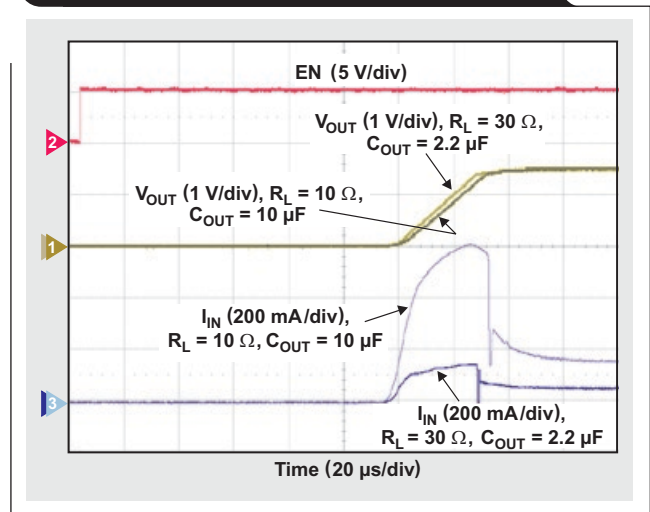

Conclusion

Historically, design engineers chose linear regulators for their low cost, simplicity, low noise, and high PSRR. Rarely did engineers consider a regulator's ability to control inrush current at start-up until after the choice was made. This oversight sometimes rendered the input power supply unable to supply enough start-up current, especially if the regulator had a large output capacitance. To continue going forward, designers had to use external circuitry to provide inrush-current control. Today, however, they can choose from a new generation of linear regulators with integrated soft start/inrush-current control. Taking soft start into consideration early in the design phase provides a problem-free system with controlled, predictable inrush current at start-up.

References

For more information related to this article, you can download an Acrobat® Reader® file at www.s.ti.com/sc/techlit/litnumber and replace "litnumber" with the **TI Lit. #** for the materials listed below.

Document Title	TI Lit. #
1. Jeff Falin, "Monotonic, Inrush Current Limited Start-Up for Linear Regulators," Application Report.	siva156

Related Web sites

power.ti.com

www.ti.com/sc/device/partnumber

Replace *partnumber* with TPS72015, TPS73525, TPS73633, or TPS74901

IMPORTANT NOTICE

Texas Instruments Incorporated and its subsidiaries (TI) reserve the right to make corrections, modifications, enhancements, improvements, and other changes to its products and services at any time and to discontinue any product or service without notice. Customers should obtain the latest relevant information before placing orders and should verify that such information is current and complete. All products are sold subject to TI's terms and conditions of sale supplied at the time of order acknowledgment.

TI warrants performance of its hardware products to the specifications applicable at the time of sale in accordance with TI's standard warranty. Testing and other quality control techniques are used to the extent TI deems necessary to support this warranty. Except where mandated by government requirements, testing of all parameters of each product is not necessarily performed.

TI assumes no liability for applications assistance or customer product design. Customers are responsible for their products and applications using TI components. To minimize the risks associated with customer products and applications, customers should provide adequate design and operating safeguards.

TI does not warrant or represent that any license, either express or implied, is granted under any TI patent right, copyright, mask work right, or other TI intellectual property right relating to any combination, machine, or process in which TI products or services are used. Information published by TI regarding third-party products or services does not constitute a license from TI to use such products or services or a warranty or endorsement thereof. Use of such information may require a license from a third party under the patents or other intellectual property of the third party, or a license from TI under the patents or other intellectual property of TI.

Reproduction of information in TI data books or data sheets is permissible only if reproduction is without alteration and is accompanied by all associated warranties, conditions, limitations, and notices. Reproduction of this information with alteration is an unfair and deceptive business practice. TI is not responsible or liable for such altered documentation. Information of third parties may be subject to additional restrictions.

Resale of TI products or services with statements different from or beyond the parameters stated by TI for that product or service voids all express and any implied warranties for the associated TI product or service and is an unfair and deceptive business practice. TI is not responsible or liable for any such statements.

TI products are not authorized for use in safety-critical applications (such as life support) where a failure of the TI product would reasonably be expected to cause severe personal injury or death, unless officers of the parties have executed an agreement specifically governing such use. Buyers represent that they have all necessary expertise in the safety and regulatory ramifications of their applications, and acknowledge and agree that they are solely responsible for all legal, regulatory and safety-related requirements concerning their products and any use of TI products in such safety-critical applications, notwithstanding any applications-related information or support that may be provided by TI. Further, Buyers must fully indemnify TI and its representatives against any damages arising out of the use of TI products in such safety-critical applications.

TI products are neither designed nor intended for use in military/aerospace applications or environments unless the TI products are specifically designated by TI as military-grade or "enhanced plastic." Only products designated by TI as military-grade meet military specifications. Buyers acknowledge and agree that any such use of TI products which TI has not designated as military-grade is solely at the Buyer's risk, and that they are solely responsible for compliance with all legal and regulatory requirements in connection with such use.

TI products are neither designed nor intended for use in automotive applications or environments unless the specific TI products are designated by TI as compliant with ISO/TS 16949 requirements. Buyers acknowledge and agree that, if they use any non-designated products in automotive applications, TI will not be responsible for any failure to meet such requirements.

Following are URLs where you can obtain information on other Texas Instruments products and application solutions:

Products		Applications	
Amplifiers	amplifier.ti.com	Audio	www.ti.com/audio
Data Converters	dataconverter.ti.com	Automotive	www.ti.com/automotive
DLP® Products	www.dlp.com	Broadband	www.ti.com/broadband
DSP	dsp.ti.com	Digital Control	www.ti.com/digitalcontrol
Clocks and Timers	www.ti.com/clocks	Medical	www.ti.com/medical
Interface	interface.ti.com	Military	www.ti.com/military
Logic	logic.ti.com	Optical Networking	www.ti.com/opticalnetwork
Power Mgmt	power.ti.com	Security	www.ti.com/security
Microcontrollers	microcontroller.ti.com	Telephony	www.ti.com/telephony
RFID	www.ti-rfid.com	Video & Imaging	www.ti.com/video
RF/IF and ZigBee® Solutions	www.ti.com/lprf	Wireless	www.ti.com/wireless

Mailing Address: Texas Instruments
Post Office Box 655303
Dallas, Texas 75265

TI Worldwide Technical Support

Internet

TI Semiconductor Product Information Center Home Page

support.ti.com

TI Semiconductor KnowledgeBase Home Page

support.ti.com/sc/knowledgebase

Product Information Centers

Americas	Phone	+1(972) 644-5580
Brazil	Phone	0800-891-2616
Mexico	Phone	0800-670-7544
	Fax	+1(972) 927-6377
	Internet/Email	support.ti.com/sc/pic/americas.htm

Europe, Middle East, and Africa

Phone	
European Free Call	00800-ASK-TEXAS (00800 275 83927)
International	+49 (0) 8161 80 2121
Russian Support	+7 (4) 95 98 10 701

Note: The European Free Call (Toll Free) number is not active in all countries. If you have technical difficulty calling the free call number, please use the international number above.

Fax	+ (49) (0) 8161 80 2045
Internet	support.ti.com/sc/pic/euro.htm

Japan

Fax	International	+81-3-3344-5317
	Domestic	0120-81-0036
Internet/Email	International	support.ti.com/sc/pic/japan.htm
	Domestic	www.tij.co.jp/pic

Asia

Phone	
International	+91-80-41381665
Domestic	<u>Toll-Free Number</u>
Australia	1-800-999-084
China	800-820-8682
Hong Kong	800-96-5941
India	1-800-425-7888
Indonesia	001-803-8861-1006
Korea	080-551-2804
Malaysia	1-800-80-3973
New Zealand	0800-446-934
Philippines	1-800-765-7404
Singapore	800-886-1028
Taiwan	0800-006800
Thailand	001-800-886-0010
Fax	+886-2-2378-6808
Email	tiasia@ti.com or ti-china@ti.com
Internet	support.ti.com/sc/pic/asia.htm

Safe Harbor Statement: This publication may contain forward-looking statements that involve a number of risks and uncertainties. These "forward-looking statements" are intended to qualify for the safe harbor from liability established by the Private Securities Litigation Reform Act of 1995. These forward-looking statements generally can be identified by phrases such as TI or its management "believes," "expects," "anticipates," "foresees," "forecasts," "estimates" or other words or phrases of similar import. Similarly, such statements herein that describe the company's products, business strategy, outlook, objectives, plans, intentions or goals also are forward-looking statements. All such forward-looking statements are subject to certain risks and uncertainties that could cause actual results to differ materially from those in forward-looking statements. Please refer to TI's most recent Form 10-K for more information on the risks and uncertainties that could materially affect future results of operations. We disclaim any intention or obligation to update any forward-looking statements as a result of developments occurring after the date of this publication.

E093008

Acrobat and Reader are registered trademarks of Adobe Systems Incorporated. All other trademarks are the property of their respective owners.