



12-BIT, QUAD, ULTRALOW GLITCH, VOLTAGE OUTPUT DIGITAL-TO-ANALOG CONVERTER

FEATURES

- 2.7-V to 5.5-V Single Supply
- 12-Bit Linearity and Monotonicity
- Rail-to-Rail Voltage Output
- Settling Time: 5 μ s (Max)
- Ultralow Glitch Energy: 0.1 nVs
- Ultralow Crosstalk: -100 dB
- Low Power: 880 μ A (Max)
- Per-Channel Power Down: 2 μ A (Max)
- Power-On Reset to Zero Scale
- SPI-Compatible Serial Interface: Up to 50 MHz
- Simultaneous or Sequential Update
- Specified Temperature Range: -40°C to 105°C
- Small 10-Lead MSOP Package

APPLICATIONS

- Portable Battery-Powered Instruments
- Digital Gain and Offset Adjustment
- Programmable Voltage and Current Sources
- Programmable Attenuators
- Industrial Process Control

DESCRIPTION

The DAC7554 is a quad-channel, voltage-output DAC with exceptional linearity and monotonicity. Its proprietary architecture minimizes undesired transients such as code to code glitch and channel to channel crosstalk. The low-power DAC7554 operates from a single 2.7-V to 5.5-V supply. The DAC7554 output amplifiers can drive a 2-k Ω , 200-pF load rail-to-rail with 5- μ s settling time; the output range is set using an external voltage reference.

The 3-wire serial interface operates at clock rates up to 50 MHz and is compatible with SPI, QSPI, Microwire, and DSP interface standards. The outputs of all DACs may be updated simultaneously or sequentially. The parts incorporate a power-on-reset circuit to ensure that the DAC outputs power up to zero volts and remain there until a valid write cycle to the device takes place. The parts contain a power-down feature that reduces the current consumption of the device to under 1 μ A.

The small size and low-power operation makes the DAC7554 ideally suited for battery-operated portable applications. The power consumption is typically 3.5 mW at 5 V, 1.65 mW at 3 V, and reduces to 1 μ W in power-down mode.

The DAC7554 is available in a 10-lead MSOP package and is specified over -40°C to 105°C .

FUNCTIONAL BLOCK DIAGRAM

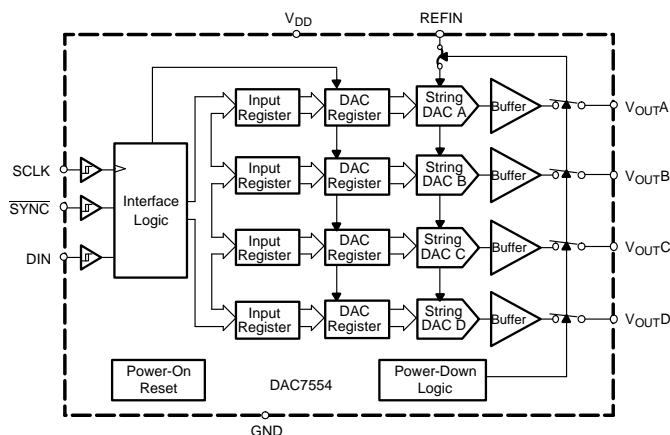

Please be aware that an important notice concerning availability, standard warranty, and use in critical applications of Texas Instruments semiconductor products and disclaimers thereto appears at the end of this data sheet.



This integrated circuit can be damaged by ESD. Texas Instruments recommends that all integrated circuits be handled with appropriate precautions. Failure to observe proper handling and installation procedures can cause damage.

ESD damage can range from subtle performance degradation to complete device failure. Precision integrated circuits may be more susceptible to damage because very small parametric changes could cause the device not to meet its published specifications.

ORDERING INFORMATION

PRODUCT	PACKAGE	PACKAGE DESIGNATOR	SPECIFIED TEMPERATURE RANGE	PACKAGE MARKING	ORDERING NUMBER	TRANSPORT MEDIA
DAC7554	10 MSOP	DGS	–40°C TO 105°C	D754	DAC7554IDGS	80-piece Tube
					DAC7554IDGSR	2500-piece Tape and Reel

ABSOLUTE MAXIMUM RATINGS

over operating free-air temperature range (unless otherwise noted)⁽¹⁾

	UNIT
V_{DD} to GND	–0.3 V to 6 V
Digital input voltage to GND	–0.3 V to $V_{DD} + 0.3$ V
V_{out} to GND	–0.3 V to $V_{DD} + 0.3$ V
Operating temperature range	–40°C to 105°C
Storage temperature range	–65°C to 150°C
Junction temperature (T_J Max)	150°C

(1) Stresses above those listed under “Absolute Maximum Ratings” may cause permanent damage to the device. Exposure to absolute maximum conditions for extended periods may affect device reliability.

ELECTRICAL CHARACTERISTICS

$V_{DD} = 2.7\text{ V to }5.5\text{ V}$, $REFIN = V_{DD}$, $R_L = 2\text{ k}\Omega$ to GND; $C_L = 200\text{ pF}$ to GND; all specifications -40°C to 105°C , unless otherwise specified

PARAMETER	TEST CONDITIONS	MIN	TYP	MAX	UNITS
STATIC PERFORMANCE⁽¹⁾					
Resolution			12		Bits
Relative accuracy			± 0.35	± 1	LSB
Differential nonlinearity	Specified monotonic by design		± 0.08	± 0.5	LSB
Offset error				± 12	mV
Zero-scale error	All zeroes loaded to DAC register			± 12	mV
Gain error				± 0.15	%FSR
Full-scale error				± 0.5	%FSR
Zero-scale error drift			7		$\mu\text{V}/^\circ\text{C}$
Gain temperature coefficient			3		ppm of FSR/ $^\circ\text{C}$
PSRR	$V_{DD} = 5\text{ V}$		0.75		mV/V
OUTPUT CHARACTERISTICS⁽²⁾					
Output voltage range		0		REFIN	V
Output voltage settling time	$R_L = 2\text{ k}\Omega$; $0\text{ pF} < C_L < 200\text{ pF}$			5	μs
Slew rate			1		V/ μs
Capacitive load stability	$R_L = \infty$		470		pF
	$R_L = 2\text{ k}\Omega$		1000		
Digital-to-analog glitch impulse	1 LSB change around major carry		0.1		nV-s
Channel-to-channel crosstalk	1-kHz full-scale sine wave, outputs unloaded		-100		dB
Digital feedthrough			0.1		nV-s
Output noise density (10-kHz offset frequency)			70		nV/rtHz
Total harmonic distortion	$F_{OUT} = 1\text{ kHz}$, $F_S = 1\text{ MSPS}$, $BW = 20\text{ kHz}$		-85		dB
DC output impedance			1		Ω
Short-circuit current	$V_{DD} = 5\text{ V}$		50		mA
	$V_{DD} = 3\text{ V}$		20		
Power-up time	Coming out of power-down mode, $V_{DD} = 5\text{ V}$		15		μs
	Coming out of power-down mode, $V_{DD} = 3\text{ V}$		15		
LOGIC INPUTS⁽²⁾					
Input current				± 1	μA
V_{IN_L} , Input low voltage	$V_{DD} = 5\text{ V}$			$0.3 V_{DD}$	V
V_{IN_H} , Input high voltage	$V_{DD} = 3\text{ V}$	$0.7 V_{DD}$			V
Pin capacitance				3	pF
POWER REQUIREMENTS					
V_{DD}		2.7		5.5	V
I_{DD} (normal operation)	DAC active and excluding load current $V_{IH} = V_{DD}$ and $V_{IL} = \text{GND}$	$V_{DD} = 3.6\text{ V to }5.5\text{ V}$	700	880	μA
		$V_{DD} = 2.7\text{ V to }3.6\text{ V}$	550	830	
I_{DD} (all power-down modes)	$V_{IH} = V_{DD}$ and $V_{IL} = \text{GND}$	$V_{DD} = 3.6\text{ V to }5.5\text{ V}$	0.2	2	μA
		$V_{DD} = 2.7\text{ V to }3.6\text{ V}$	0.05	2	
Reference input impedance			25		k Ω
POWER EFFICIENCY					
I_{OUT}/I_{DD}	$I_{LOAD} = 2\text{ mA}$, $V_{DD} = 5\text{ V}$		93%		

(1) Linearity tested using a reduced code range of 48 to 4048; output unloaded.

(2) Specified by design and characterization, not production tested.

TIMING CHARACTERISTICS⁽¹⁾⁽²⁾

V_{DD} = 2.7 V to 5.5 V, R_L = 2 kΩ to GND; all specifications –40°C to 105°C, unless otherwise specified

PARAMETER		TEST CONDITIONS	MIN	TYP	MAX	UNITS
t ₁ ⁽³⁾	SCLK cycle time	V _{DD} = 2.7 V to 3.6 V	20			ns
		V _{DD} = 3.6 V to 5.5 V	20			
t ₂	SCLK HIGH time	V _{DD} = 2.7 V to 3.6 V	10			ns
		V _{DD} = 3.6 V to 5.5 V	10			
t ₃	SCLK LOW time	V _{DD} = 2.7 V to 3.6 V	10			ns
		V _{DD} = 3.6 V to 5.5 V	10			
t ₄	$\overline{\text{SYNC}}$ falling edge to SCLK falling edge setup time	V _{DD} = 2.7 V to 3.6 V	4			ns
		V _{DD} = 3.6 V to 5.5 V	4			
t ₅	Data setup time	V _{DD} = 2.7 V to 3.6 V	5			ns
		V _{DD} = 3.6 V to 5.5 V	5			
t ₆	Data hold time	V _{DD} = 2.7 V to 3.6 V	4.5			ns
		V _{DD} = 3.6 V to 5.5 V	4.5			
t ₇	SCLK falling edge to $\overline{\text{SYNC}}$ rising edge	V _{DD} = 2.7 V to 3.6 V	0			ns
		V _{DD} = 3.6 V to 5.5 V	0			
t ₈	Minimum $\overline{\text{SYNC}}$ HIGH time	V _{DD} = 2.7 V to 3.6 V	20			ns
		V _{DD} = 3.6 V to 5.5 V	20			

- (1) All input signals are specified with t_R = t_F = 1 ns (10% to 90% of V_{DD}) and timed from a voltage level of (V_{IL} + V_{IH})/2.
- (2) See Serial Write Operation timing diagram Figure 1.
- (3) Maximum SCLK frequency is 50 MHz at V_{DD} = 2.7 V to 5.5 V.

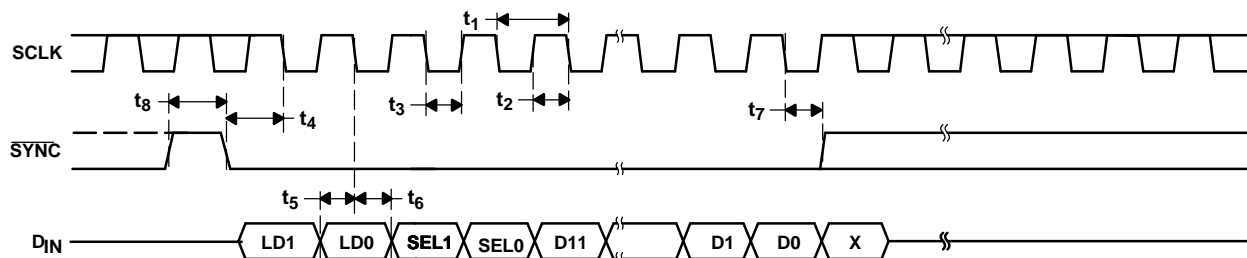
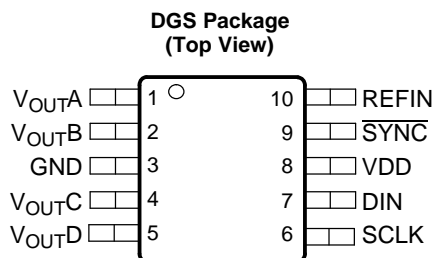

Figure 1. Serial Write Operation

PIN DESCRIPTION



Terminal Functions

TERMINAL		DESCRIPTION
NO.	NAME	
1	VOUTA	Analog output voltage from DAC A
2	VOUTB	Analog output voltage from DAC B
3	GND	Ground
4	VOUTC	Analog output voltage from DAC C
5	VOUTD	Analog output voltage from DAC D
6	SCLK	Serial clock input
7	DIN	Serial data input
8	VDD	Analog voltage supply input
9	SYNC	Frame synchronization input. The falling edge of the FS pulse indicates the start of a serial data frame shifted out to the DAC7554
10	REFIN	Analog input. External reference

TYPICAL CHARACTERISTICS

LINEARITY ERROR AND
DIFFERENTIAL LINEARITY ERROR
VS
DIGITAL INPUT CODE

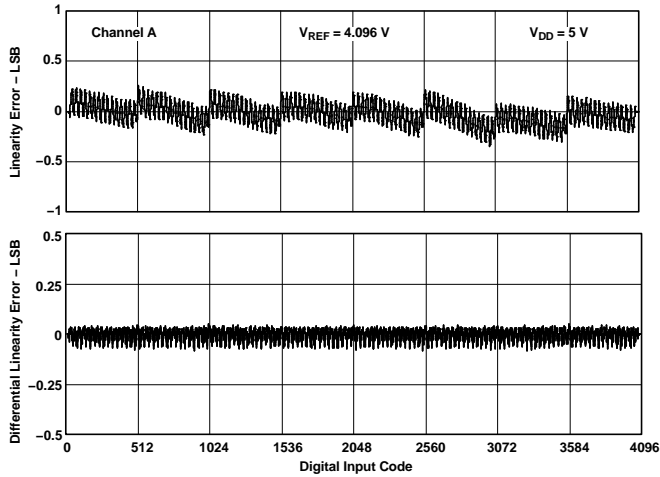

Figure 2.

LINEARITY ERROR AND
DIFFERENTIAL LINEARITY ERROR
VS
DIGITAL INPUT CODE

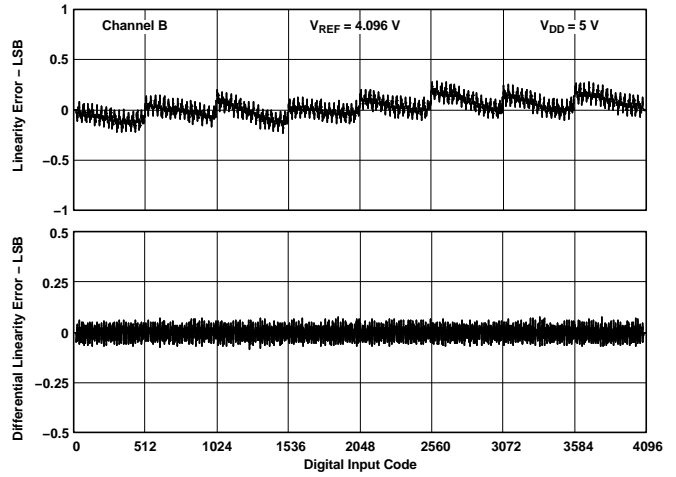

Figure 3.

LINEARITY ERROR AND
DIFFERENTIAL LINEARITY ERROR
VS
DIGITAL INPUT CODE

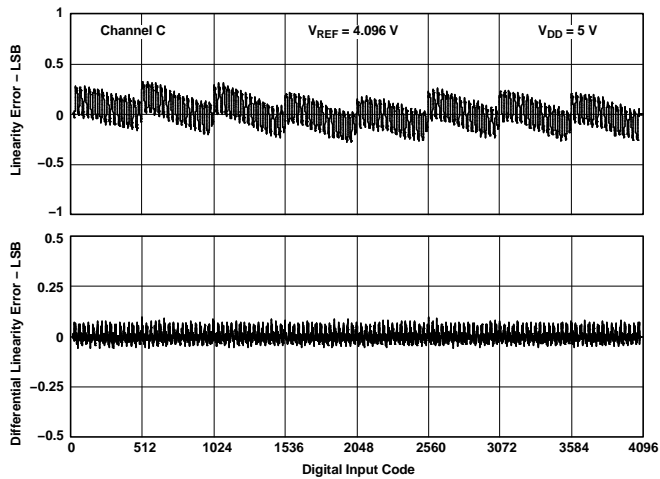

Figure 4.

LINEARITY ERROR AND
DIFFERENTIAL LINEARITY ERROR
VS
DIGITAL INPUT CODE

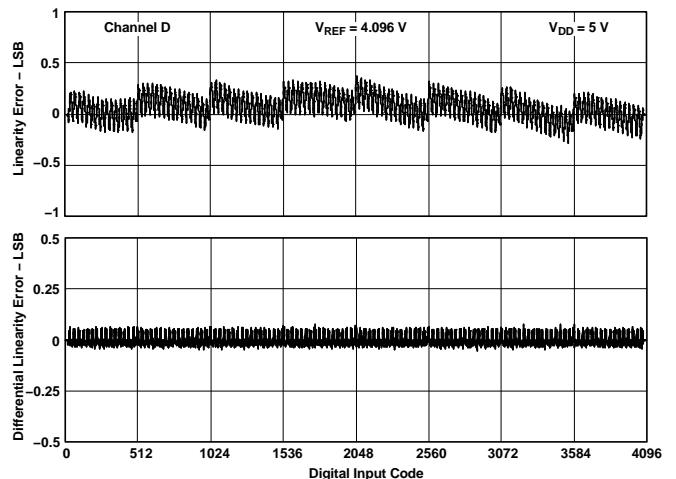

Figure 5.

TYPICAL CHARACTERISTICS (continued)

**LINEARITY ERROR AND
 DIFFERENTIAL LINEARITY ERROR
 VS
 DIGITAL INPUT CODE**

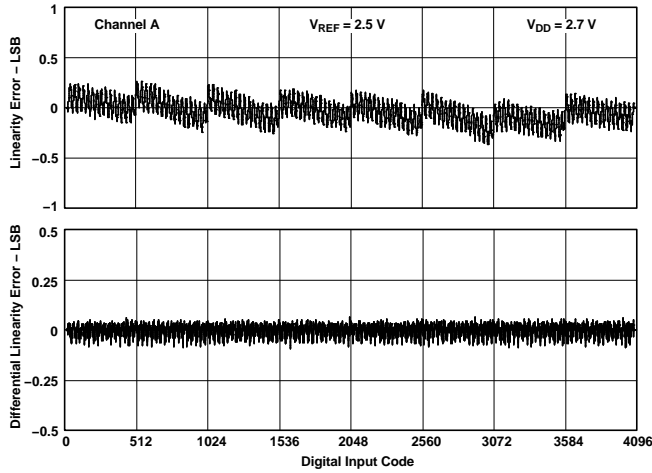

Figure 6.

**LINEARITY ERROR AND
 DIFFERENTIAL LINEARITY ERROR
 VS
 DIGITAL INPUT CODE**

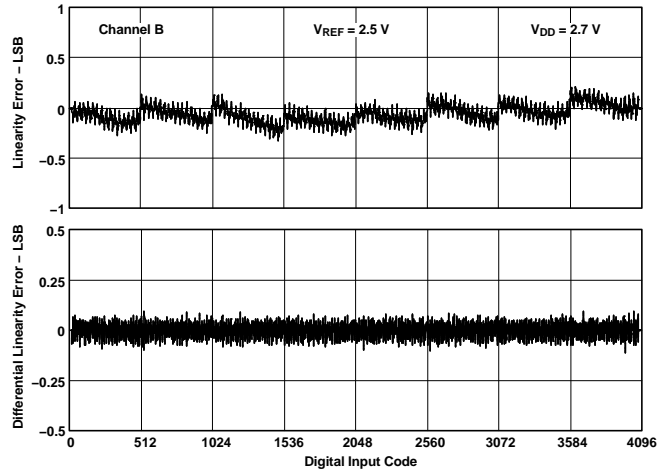

Figure 7.

**LINEARITY ERROR AND
 DIFFERENTIAL LINEARITY ERROR
 VS
 DIGITAL INPUT CODE**

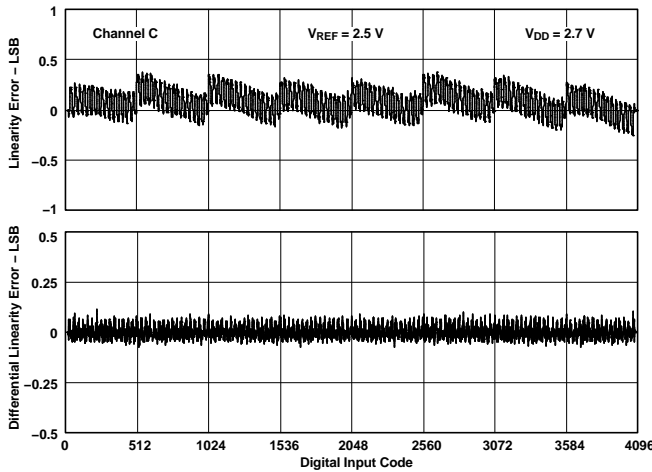

Figure 8.

**LINEARITY ERROR AND
 DIFFERENTIAL LINEARITY ERROR
 VS
 DIGITAL INPUT CODE**

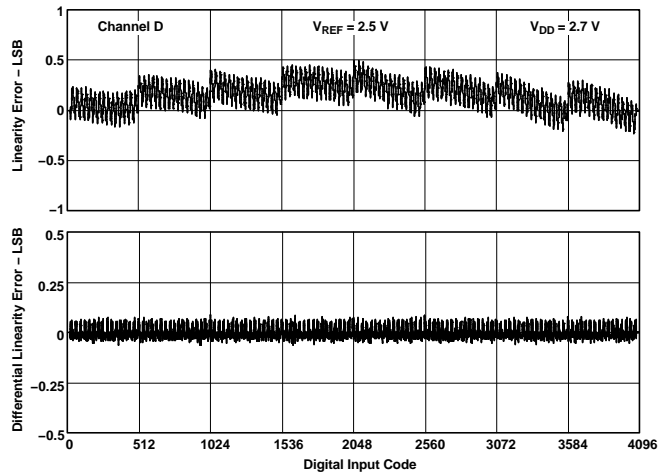

Figure 9.

TYPICAL CHARACTERISTICS (continued)

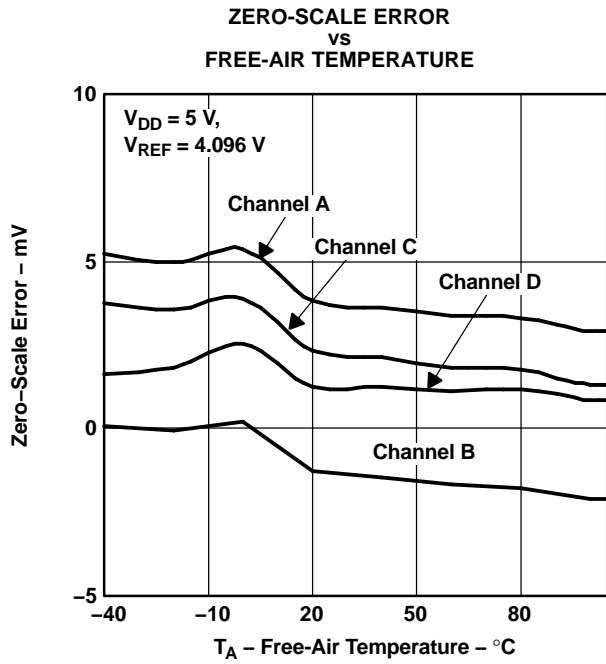

Figure 10.

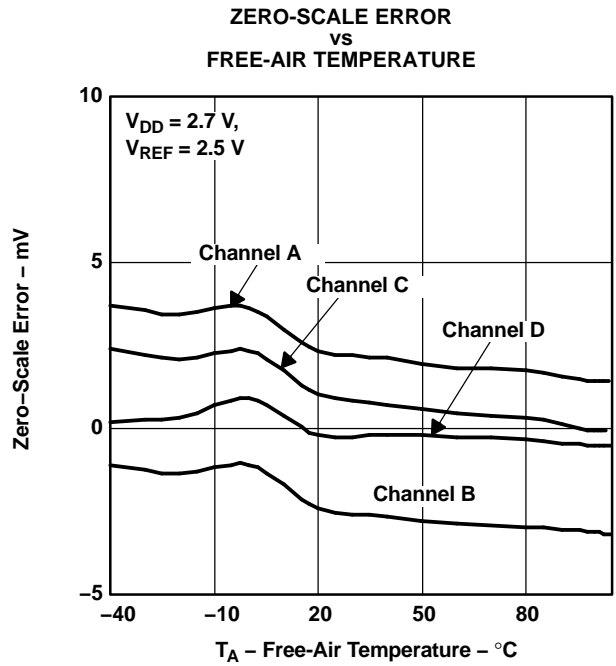

Figure 11.

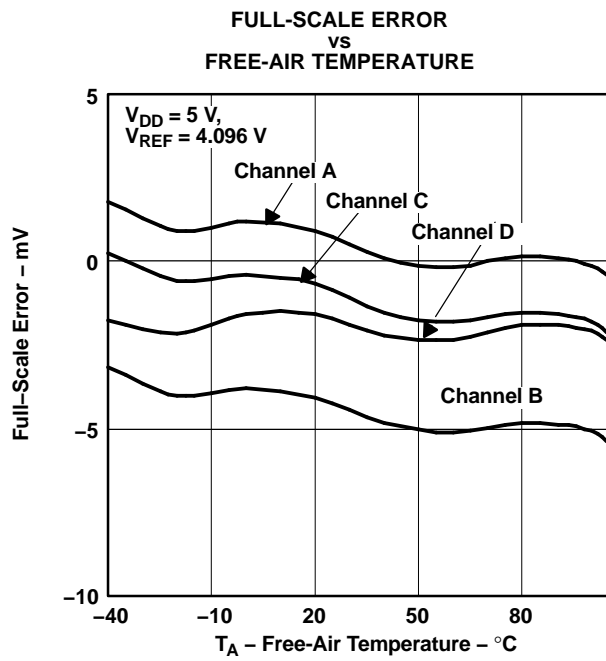

Figure 12.

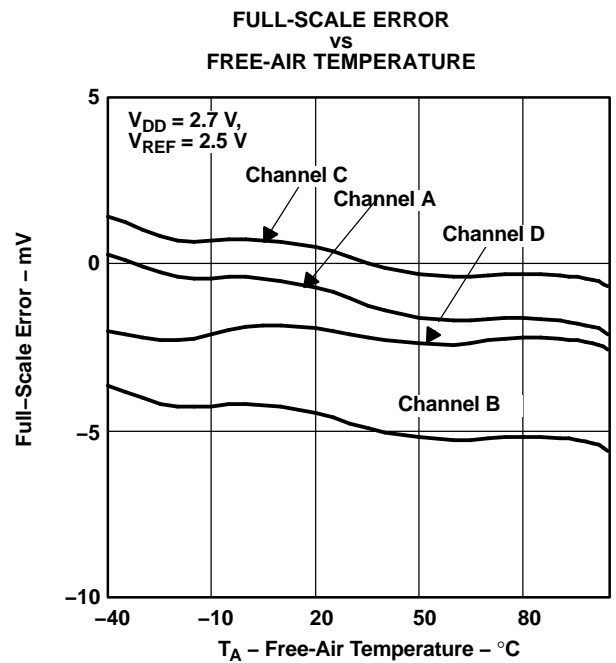

Figure 13.

TYPICAL CHARACTERISTICS (continued)

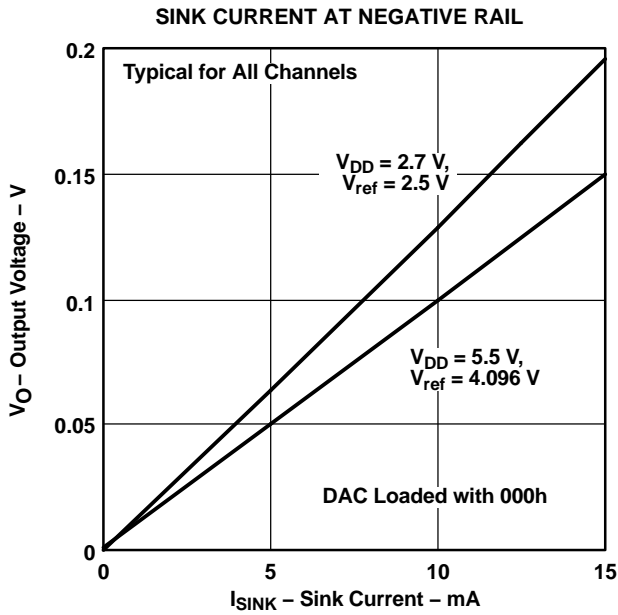

Figure 14.

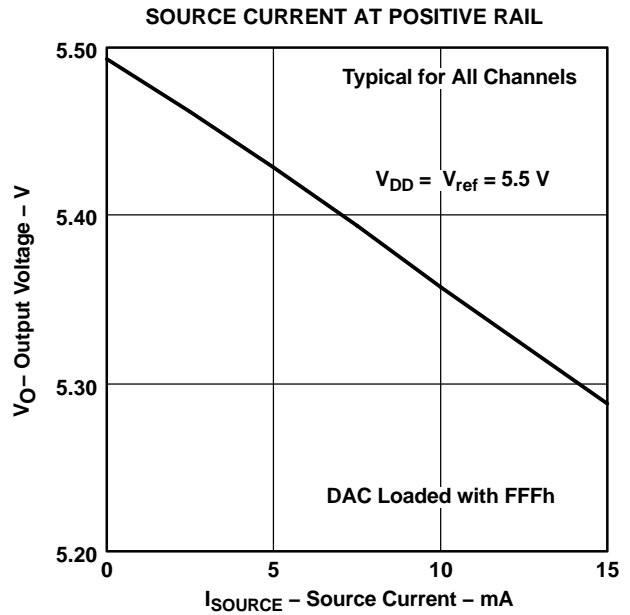

Figure 15.

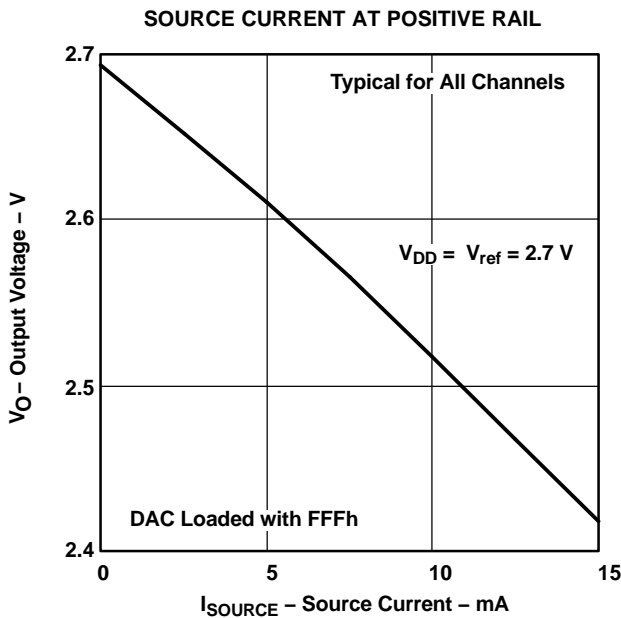

Figure 16.

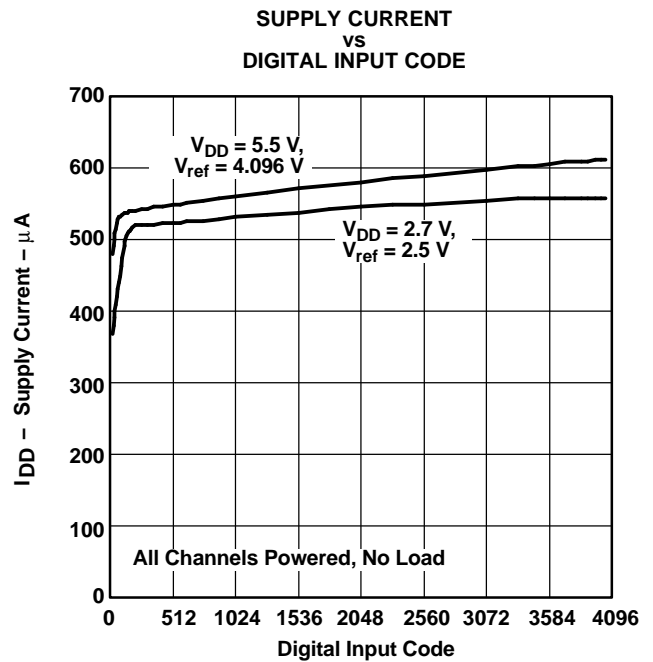
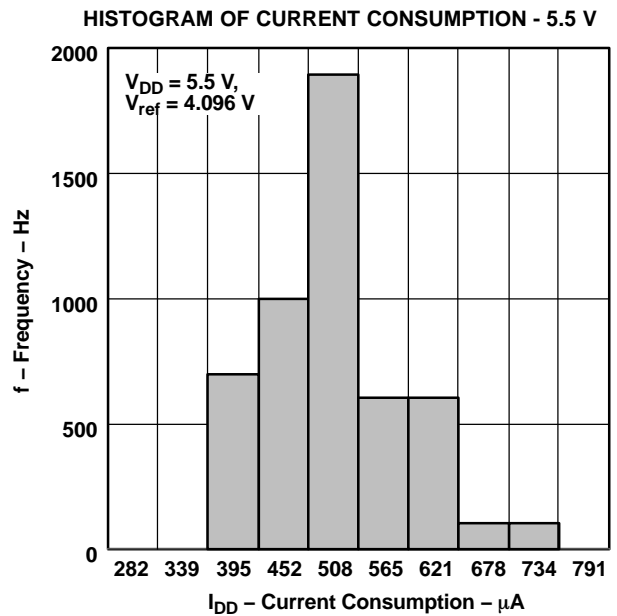
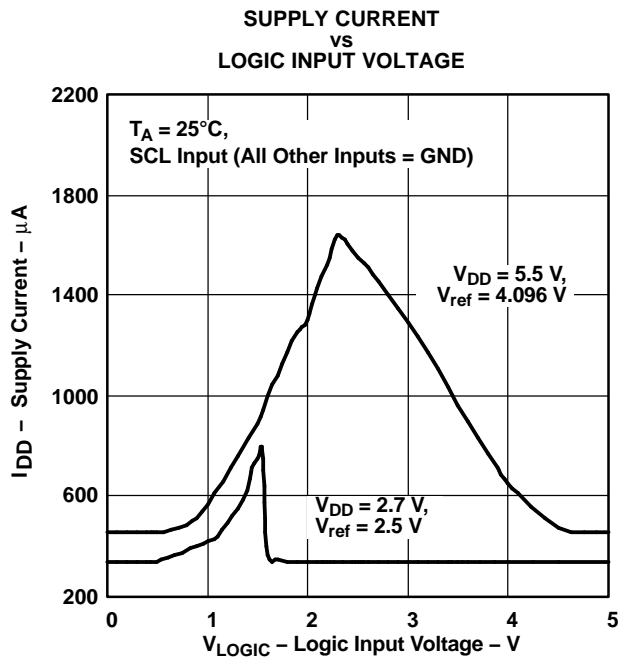
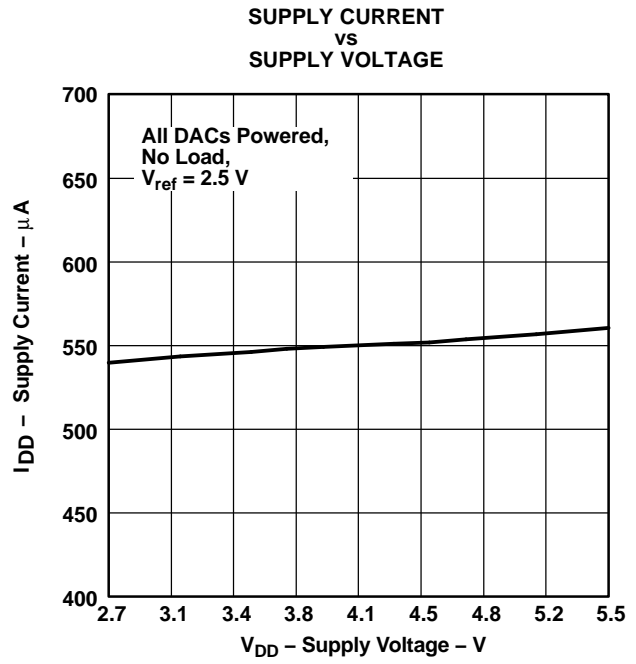
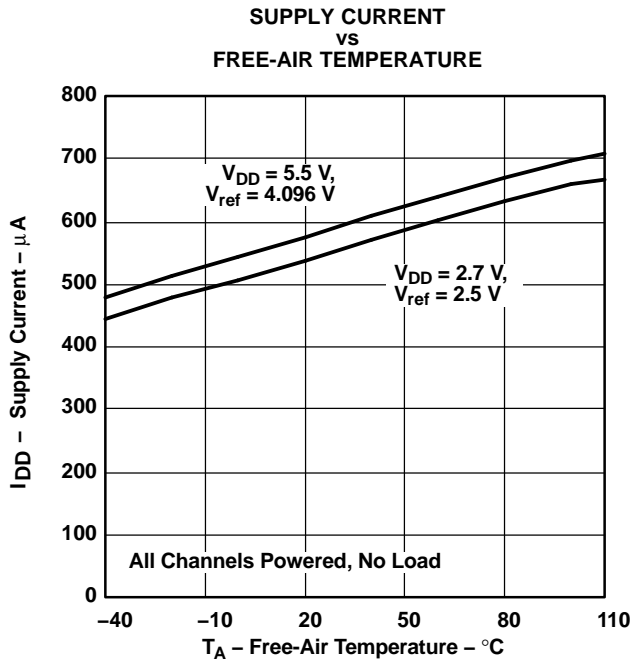

Figure 17.

TYPICAL CHARACTERISTICS (continued)



TYPICAL CHARACTERISTICS (continued)

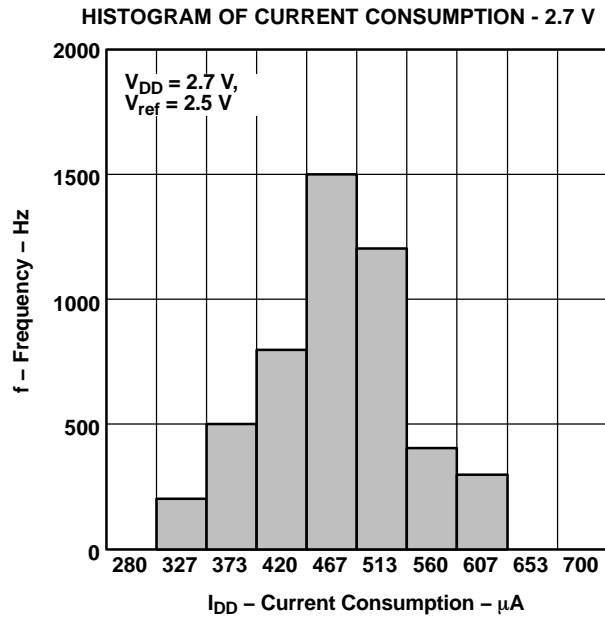

Figure 22.

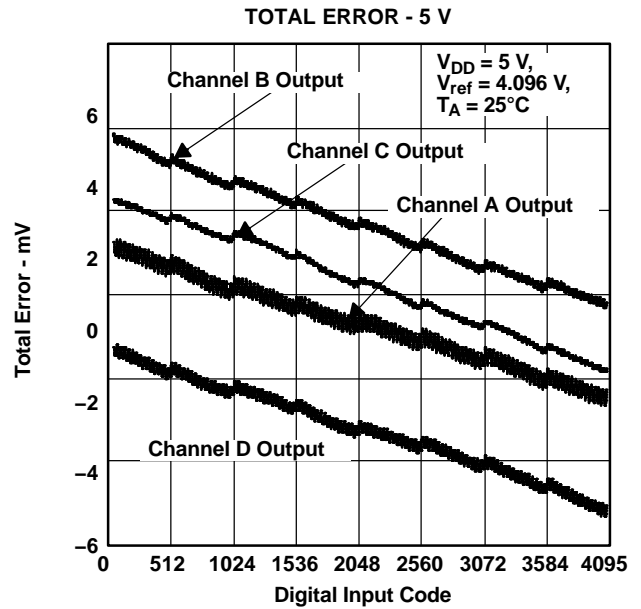

Figure 23.

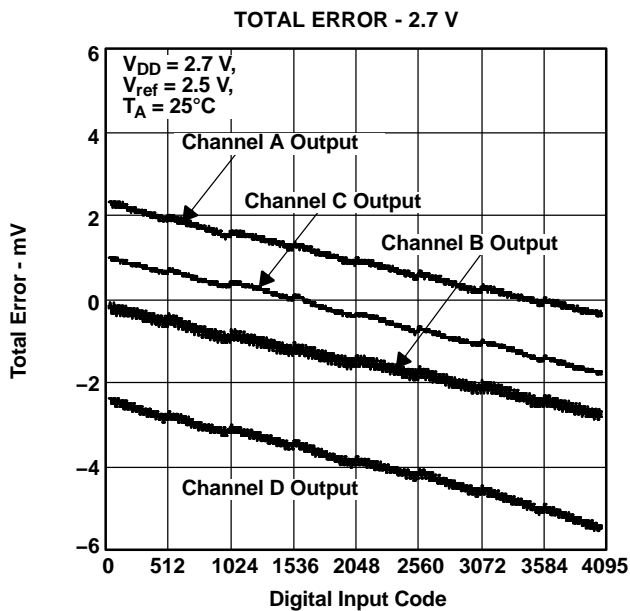

Figure 24.

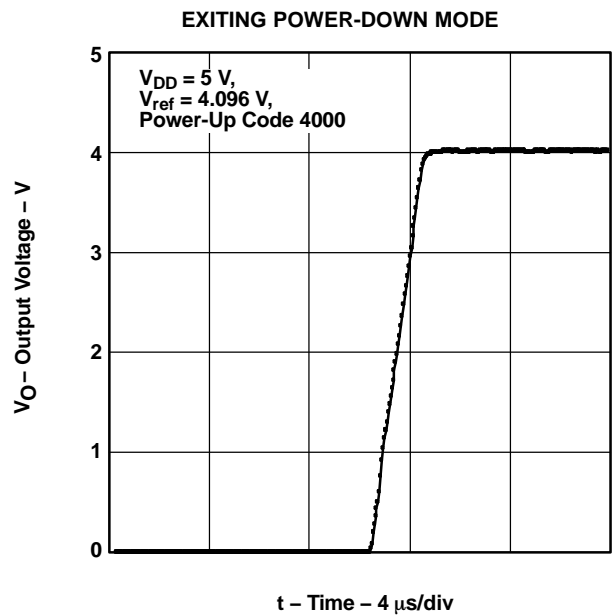

Figure 25.

TYPICAL CHARACTERISTICS (continued)

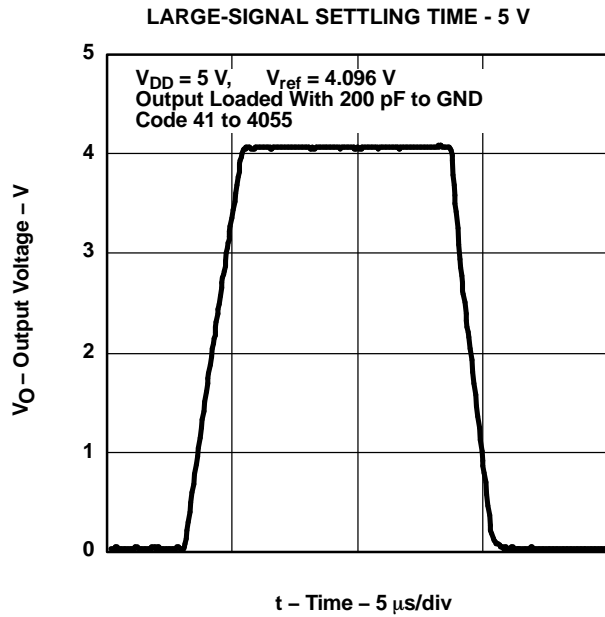

Figure 26.

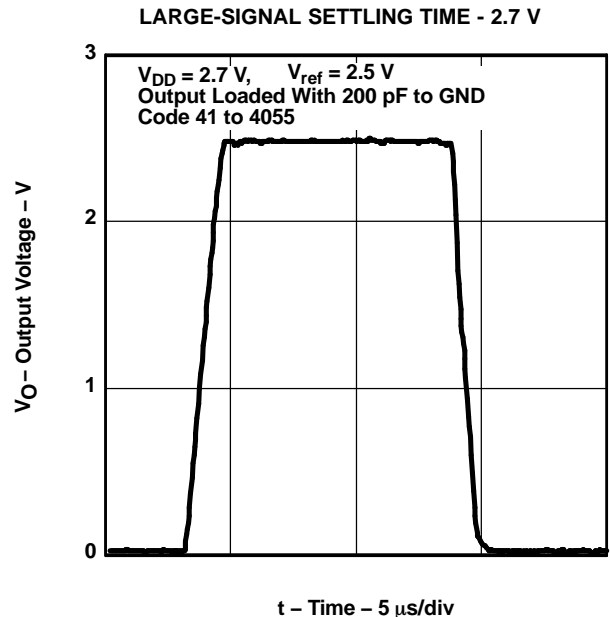

Figure 27.

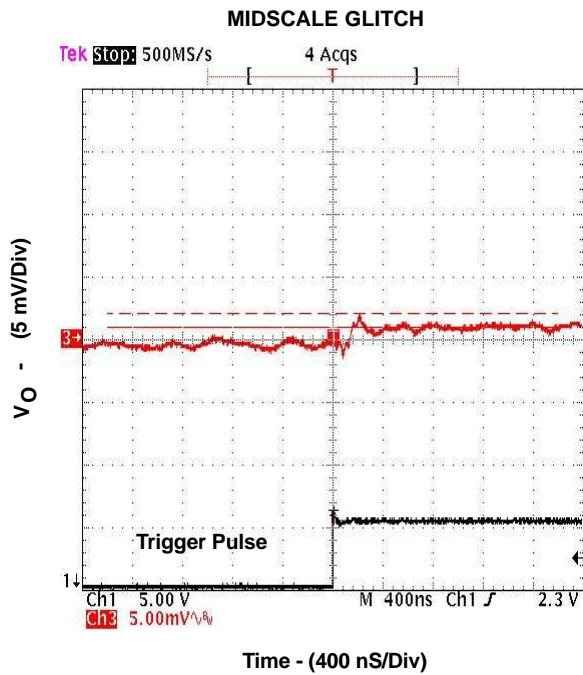

Figure 28.

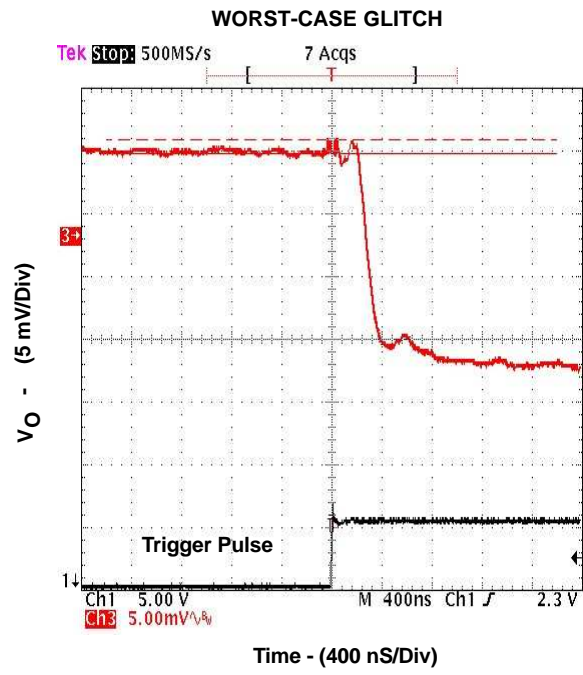

Figure 29.

TYPICAL CHARACTERISTICS (continued)

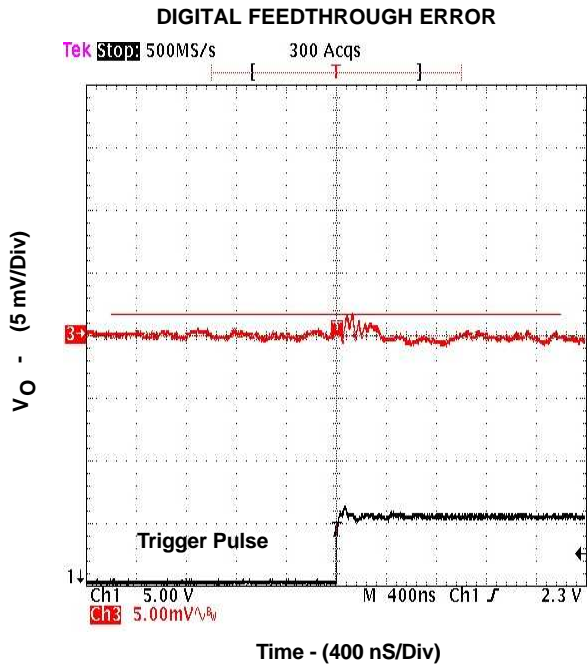

Figure 30.

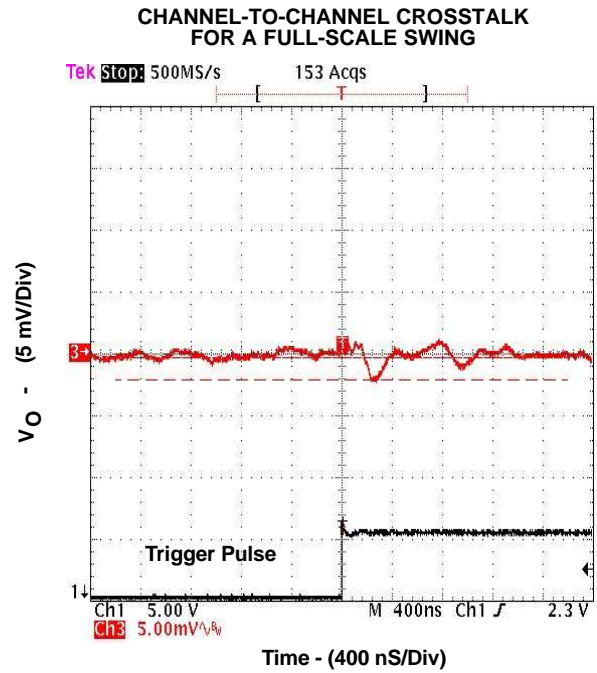

Figure 31.

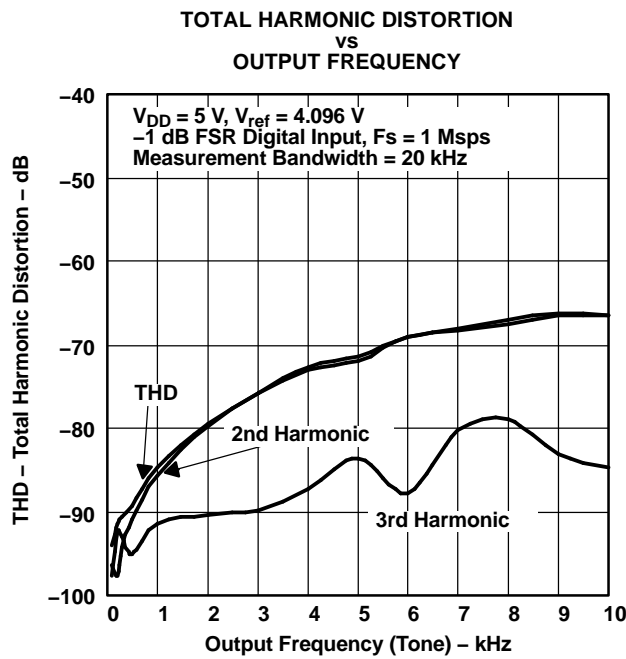

Figure 32.

3-Wire Serial Interface

The DAC7554 digital interface is a standard 3-wire SPI/QSPI/Microwire/DSP-compatible interface.

Table 1. Serial Interface Programming

CONTROL				DATA BITS	DAC(s)	FUNCTION
LD1	LD0	Sel1	Sel0	DB11-DB0		
0	0	0	0	data	A	Input register updated
0	0	0	1	data	B	Input register updated
0	0	1	0	data	C	Input register updated
0	0	1	1	data	D	Input register updated
0	1	0	0	data	A	DAC register updated, output updated
0	1	0	1	data	B	DAC register updated, output updated
0	1	1	0	data	C	DAC register updated, output updated
0	1	1	1	data	D	DAC register updated, output updated
1	0	0	0	data	A	Input register and DAC register updated, output updated
1	0	0	1	data	B	Input register and DAC register updated, output updated
1	0	1	0	data	C	Input register and DAC register updated, output updated
1	0	1	1	data	D	Input register and DAC register updated, output updated
1	1	0	0	data	A-D	Input register updated
1	1	0	1	data	A-D	DAC register updated, output updated
1	1	1	0	data	A-D	Input register and DAC register updated, output updated
1	1	1	1	data	--	Power-Down Mode - See Table 2
Sel1	Sel0	CHANNEL SELECT				
0	0	Channel A				
0	1	Channel B				
1	0	Channel C				
1	1	Channel D				
LD1	LD0	FUNCTION				
0	0	Single channel store. The selected input register is updated.				
0	1	Single channel DAC update. The selected DAC register is updated with input register information.				
1	0	Single channel update. The selected input and DAC register is updated.				
1	1	Depends on the Sel1 and Sel0 Bits				

POWER-DOWN MODE

In power-down mode, the DAC outputs are programmed to one of three output impedances, 1 k Ω , 100 k Ω , or floating.

Table 2. Power-Down Mode Control

EXTENDED CONTROL				DATA BITS						FUNCTION
LD1	LD0	Sel1	Sel0	DB11	DB10	DB9	DB8	DB7	DB6-DB0	
1	1	1	1	0	0	0	0	0	X	PWD Hi-Z (selected channel = A)
1	1	1	1	0	0	0	0	1	X	PWD 1 k Ω (selected channel = A)
1	1	1	1	0	0	0	1	0	X	PWD 100 k Ω (selected channel = A)
1	1	1	1	0	0	0	1	1	X	PWD Hi-Z (selected channel = A)
1	1	1	1	0	0	1	0	0	X	PWD Hi-Z (selected channel = B)
1	1	1	1	0	0	1	0	1	X	PWD 1 k Ω (selected channel = B)
1	1	1	1	0	0	1	1	0	X	PWD 100 k Ω (selected channel = B)
1	1	1	1	0	0	1	1	1	X	PWD Hi-Z (selected channel = B)
1	1	1	1	0	1	0	0	0	X	PWD Hi-Z (selected channel = C)
1	1	1	1	0	1	0	0	1	X	PWD 1 k Ω (selected channel = C)
1	1	1	1	0	1	0	1	0	X	PWD 100 k Ω (selected channel = C)
1	1	1	1	0	1	0	1	1	X	PWD Hi-Z (selected channel = C)
1	1	1	1	0	1	1	0	0	X	PWD Hi-Z (selected channel = D)
1	1	1	1	0	1	1	0	1	X	PWD 1 k Ω (selected channel = D)
1	1	1	1	0	1	1	1	0	X	PWD 100 k Ω (selected channel = D)
1	1	1	1	0	1	1	1	1	X	PWD Hi-Z (selected channel = D)
1	1	1	1	1	X	X	0	0	X	PWD Hi-Z (all channels)
1	1	1	1	1	X	X	0	1	X	PWD 1 k Ω (all channels)
1	1	1	1	1	X	X	1	0	X	PWD 100 k Ω (all channels)
1	1	1	1	1	X	X	1	1	X	PWD Hi-Z (all channels)
DB11	ALL CHANNELS FLAG									
0	See DB7–DB10									
1	DB10 and DB9 are Don't Care									
DB10	DB9	Channel Select								
0	0	Channel A								
0	1	Channel B								
1	0	Channel C								
1	1	Channel D								
DB8	DB7	Power-Down Mode								
0	0	Power-down Hi-Z								
0	1	Power-down 1 k Ω								
1	0	Power-down 100 k Ω								
1	1	Power-down Hi-Z								

THEORY OF OPERATION

D/A SECTION

The architecture of the DAC7554 consists of a string DAC followed by an output buffer amplifier. Figure 33 shows a generalized block diagram of the DAC architecture.

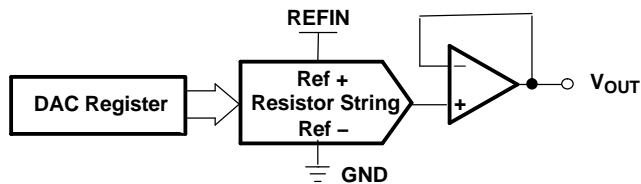

Figure 33. Typical DAC Architecture

The input coding to the DAC7554 is unsigned binary, which gives the ideal output voltage as:

$$V_{OUT} = REF_{IN} \times D/4096$$

Where D = decimal equivalent of the binary code that is loaded to the DAC register which can range from 0 to 4095.

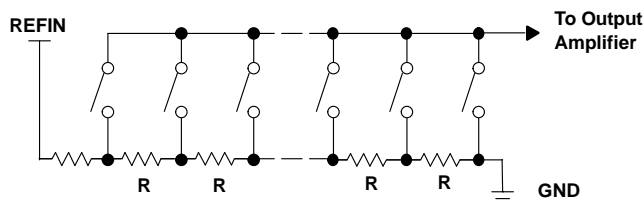

Figure 34. Typical Resistor String

RESISTOR STRING

The resistor string section is shown in Figure 34. It is simply a string of resistors, each of value R. The digital code loaded to the DAC register determines at which node on the string the voltage is tapped off to be fed into the output amplifier. The voltage is tapped off by closing one of the switches connecting the string to the amplifier. Because it is a string of resistors, it is specified monotonic. The DAC7554 architecture uses four separate resistor strings to minimize channel-to-channel crosstalk.

OUTPUT BUFFER AMPLIFIERS

The output buffer amplifier is capable of generating rail-to-rail voltages on its output, which gives an output range of 0 V to V_{DD} . It is capable of driving a load of 2 k Ω in parallel with up to 1000 pF to GND. The source and sink capabilities of the output amplifier can be seen in the typical curves. The slew rate is 1 V/ μ s with a half-scale settling time of 3 μ s with the output unloaded.

DAC External Reference Input

There is a single reference input pin for the four DACs. The reference input is unbuffered. The user can have a reference voltage as low as 0.25 V and as high as V_{DD} because there is no restriction due to headroom and footroom of any reference amplifier.

It is recommended to use a buffered reference in the external circuit (e.g., REF3140). The input impedance is typically 25 k Ω .

Power-On Reset

On power up, all internal registers are cleared and all channels are updated with zero-scale voltages. Until valid data is written, all DAC outputs remain in this state. This is particularly useful in applications where it is important to know the state of the DAC outputs while the device is powering up. In order not to turn on ESD protection devices, V_{DD} should be applied before any other pin is brought high.

Power Down

The DAC7554 has a flexible power-down capability as described in Table 2. Individual channels could be powered down separately or all channels could be powered down simultaneously. During a power-down condition, the user has flexibility to select the output impedance of each channel. During power-down operation, each channel can have either 1-k Ω , 100-k Ω , or Hi-Z output impedance to ground.

SERIAL INTERFACE

The DAC7554 is controlled over a versatile 3-wire serial interface, which operates at clock rates up to 50 MHz and is compatible with SPI, QSPI, Microwire, and DSP interface standards.

16-Bit Word and Input Shift Register

The input shift register is 16 bits wide. DAC data is loaded into the device as a 16-bit word under the control of a serial clock input, SCLK, as shown in the Figure 1 timing diagram. The 16-bit word, illustrated in Table 1, consists of four control bits followed by 12 bits of DAC data. The data format is straight binary with all zeroes corresponding to 0-V output and all ones corresponding to full-scale output ($V_{REF} - 1$ LSB). Data is loaded MSB first (Bit 15) where the first two bits (LD1 and LD0) determine if the input register, DAC register, or both are updated with shift register input data. Bit 13 and bit 12 (Sel1 and Sel0) determine whether the data is for DAC A, DAC B, DAC C, DAC D, or all DACs. All channels are updated when bits 15 and 14 (LD1 and LD0) are high.

The $\overline{\text{SYNC}}$ input is a level-triggered input that acts as a frame synchronization signal and chip enable. Data can only be transferred into the device while $\overline{\text{SYNC}}$ is low. To start the serial data transfer, $\overline{\text{SYNC}}$ should be taken low, observing the minimum $\overline{\text{SYNC}}$ to SCLK falling edge setup time, t_4 . After $\overline{\text{SYNC}}$ goes low, serial data is shifted into the device's input shift register on the falling edges of SCLK for 16 clock pulses. Any data and clock pulses after the sixteenth falling edge of SCLK are ignored. No further serial data transfer occurs until $\overline{\text{SYNC}}$ is taken high and low again.

$\overline{\text{SYNC}}$ may be taken high after the falling edge of the sixteenth SCLK pulse, observing the minimum SCLK falling edge to $\overline{\text{SYNC}}$ rising edge time, t_7 .

After the end of serial data transfer, data is automatically transferred from the input shift register to the input register of the selected DAC. If $\overline{\text{SYNC}}$ is taken high before the sixteenth falling edge of SCLK, the data transfer is aborted and the DAC input registers are not updated.

INTEGRAL AND DIFFERENTIAL LINEARITY

The DAC7554 uses precision thin-film resistors providing exceptional linearity and monotonicity. Integral linearity error is typically within (+/-) 0.35 LSBs, and differential linearity error is typically within (+/-) 0.08 LSBs.

GLITCH ENERGY

The DAC7554 uses a proprietary architecture that minimizes glitch energy. The code-to-code glitches are so low, they are usually buried within the wide-band noise and cannot be easily detected. The DAC7554 glitch is typically well under 0.1 nV-s. Such low glitch energy provides more than 10X improvement over industry alternatives.

CHANNEL-TO-CHANNEL CROSSTALK

The DAC7554 architecture is designed to minimize channel-to-channel crosstalk. The voltage change in one channel does not affect the voltage output in another channel. The DC crosstalk is in the order of a few microvolts. AC crosstalk is also less than -100 dBs. This provides orders of magnitude improvement over certain competing architectures.

APPLICATION INFORMATION

Waveform Generation

Due to its exceptional linearity, low glitch, and low crosstalk, the DAC7554 is well suited for waveform generation (from DC to 10 kHz). The DAC7554 large-signal settling time is 5 μs , supporting an update rate of 200 KSPS. However, the update rates

can exceed 1 MSPS if the waveform to be generated consists of small voltage steps between consecutive DAC updates. To obtain a high dynamic range, REF3140 (4.096 V) or REF02 (5.0 V) are recommended for reference voltage generation.

Generating $\pm 5\text{-V}$, $\pm 10\text{-V}$, and $\pm 12\text{-V}$ Outputs For Precision Industrial Control

Industrial control applications can require multiple feedback loops consisting of sensors, ADCs, MCUs, DACs, and actuators. Loop accuracy and loop speed are the two important parameters of such control loops.

Loop Accuracy:

In a control loop, the ADC has to be accurate. Offset, gain, and the integral linearity errors of the DAC are not factors in determining the accuracy of the loop. As long as a voltage exists in the transfer curve of a monotonic DAC, the loop can find it and settle to it. On the other hand, DAC resolution and differential linearity do determine the loop accuracy, because each DAC step determines the minimum incremental change the loop can generate. A DNL error less than -1 LSB (non-monotonicity) can create loop instability. A DNL error greater than +1 LSB implies unnecessarily large voltage steps and missed voltage targets. With high DNL errors, the loop loses its stability, resolution, and accuracy. Offering 12-bit ensured monotonicity and ± 0.08 LSB typical DNL error, 755X DACs are great choices for precision control loops.

Loop Speed:

Many factors determine control loop speed. Typically, the ADC's conversion time, and the MCU's computation time are the two major factors that dominate the time constant of the loop. DAC settling time is rarely a dominant factor because ADC conversion times usually exceed DAC conversion times. DAC offset, gain, and linearity errors can slow the loop down only during the start-up. Once the loop reaches its steady-state operation, these errors do not affect loop speed any further. Depending on the ringing characteristics of the loop's transfer function, DAC glitches can also slow the loop down. With its 1 MSPS (small-signal) maximum data update rate, DAC7554 can support high-speed control loops. Ultra-low glitch energy of the DAC7554 significantly improves loop stability and loop settling time.

Generating Industrial Voltage Ranges:

For control loop applications, DAC gain and offset errors are not important parameters. This could be exploited to lower trim and calibration costs in a high-voltage control circuit design. Using a quad operational amplifier (OPA4130), and a voltage reference (REF3140), the DAC7554 can generate the wide voltage swings required by the control loop.

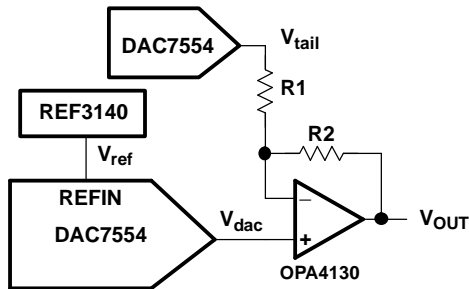

Figure 35. Low-cost, Wide-swing Voltage Generator for Control Loop Applications

The output voltage of the configuration is given by:

$$V_{out} = V_{ref} \left(\frac{R2}{R1} + 1 \right) \frac{Din}{4096} - V_{tail} \frac{R2}{R1} \quad (1)$$

Fixed R1 and R2 resistors can be used to coarsely set the gain required in the first term of the equation. Once R2 and R1 set the gain to include some minimal over-range, a DAC7554 channel could be used to set the required offset voltages. Residual errors are not an issue for loop accuracy because offset and gain errors could be tolerated. One DAC7554 channel can provide the Vtail voltage, while the other three DAC7554 channels can provide Vdac voltages to help generate three high-voltage outputs.

For ±5-V operation: R1=10 kΩ, R2 = 15 kΩ, Vtail = 3.33 V, Vref = 4.096 V

For ±10-V operation: R1=10 kΩ, R2 = 39 kΩ, Vtail = 2.56 V, Vref = 4.096 V

For ±12-V operation: R1=10 kΩ, R2 = 49 kΩ, Vtail = 2.45 V, Vref = 4.096 V

PACKAGING INFORMATION

Orderable Device	Status (1)	Package Type	Package Drawing	Pins	Package Qty	Eco Plan (2)	Lead finish/ Ball material (6)	MSL Peak Temp (3)	Op Temp (°C)	Device Marking (4/5)	Samples
DAC7554IDGS	ACTIVE	VSSOP	DGS	10	80	RoHS & Green	NIPDAUAG	Level-1-260C-UNLIM	-40 to 105	D754	Samples
DAC7554IDGSR	ACTIVE	VSSOP	DGS	10	2500	RoHS & Green	NIPDAUAG SN	Level-1-260C-UNLIM	-40 to 105	D754	Samples
DAC7554IDGSRG4	ACTIVE	VSSOP	DGS	10	2500	RoHS & Green	SN	Level-1-260C-UNLIM	-40 to 105	D754	Samples

(1) The marketing status values are defined as follows:

ACTIVE: Product device recommended for new designs.

LIFEBUY: TI has announced that the device will be discontinued, and a lifetime-buy period is in effect.

NRND: Not recommended for new designs. Device is in production to support existing customers, but TI does not recommend using this part in a new design.

PREVIEW: Device has been announced but is not in production. Samples may or may not be available.

OBSOLETE: TI has discontinued the production of the device.

(2) **RoHS:** TI defines "RoHS" to mean semiconductor products that are compliant with the current EU RoHS requirements for all 10 RoHS substances, including the requirement that RoHS substance do not exceed 0.1% by weight in homogeneous materials. Where designed to be soldered at high temperatures, "RoHS" products are suitable for use in specified lead-free processes. TI may reference these types of products as "Pb-Free".

RoHS Exempt: TI defines "RoHS Exempt" to mean products that contain lead but are compliant with EU RoHS pursuant to a specific EU RoHS exemption.

Green: TI defines "Green" to mean the content of Chlorine (Cl) and Bromine (Br) based flame retardants meet JS709B low halogen requirements of <=1000ppm threshold. Antimony trioxide based flame retardants must also meet the <=1000ppm threshold requirement.

(3) MSL, Peak Temp. - The Moisture Sensitivity Level rating according to the JEDEC industry standard classifications, and peak solder temperature.

(4) There may be additional marking, which relates to the logo, the lot trace code information, or the environmental category on the device.

(5) Multiple Device Markings will be inside parentheses. Only one Device Marking contained in parentheses and separated by a "~" will appear on a device. If a line is indented then it is a continuation of the previous line and the two combined represent the entire Device Marking for that device.

(6) Lead finish/Ball material - Orderable Devices may have multiple material finish options. Finish options are separated by a vertical ruled line. Lead finish/Ball material values may wrap to two lines if the finish value exceeds the maximum column width.

Important Information and Disclaimer:The information provided on this page represents TI's knowledge and belief as of the date that it is provided. TI bases its knowledge and belief on information provided by third parties, and makes no representation or warranty as to the accuracy of such information. Efforts are underway to better integrate information from third parties. TI has taken and continues to take reasonable steps to provide representative and accurate information but may not have conducted destructive testing or chemical analysis on incoming materials and chemicals. TI and TI suppliers consider certain information to be proprietary, and thus CAS numbers and other limited information may not be available for release.

In no event shall TI's liability arising out of such information exceed the total purchase price of the TI part(s) at issue in this document sold by TI to Customer on an annual basis.

TAPE AND REEL INFORMATION

QUADRANT ASSIGNMENTS FOR PIN 1 ORIENTATION IN TAPE

*All dimensions are nominal

Device	Package Type	Package Drawing	Pins	SPQ	Reel Diameter (mm)	Reel Width W1 (mm)	A0 (mm)	B0 (mm)	K0 (mm)	P1 (mm)	W (mm)	Pin1 Quadrant
DAC7554IDGSR	VSSOP	DGS	10	2500	330.0	12.4	5.3	3.4	1.4	8.0	12.0	Q1

TAPE AND REEL BOX DIMENSIONS

*All dimensions are nominal

Device	Package Type	Package Drawing	Pins	SPQ	Length (mm)	Width (mm)	Height (mm)
DAC7554IDGSR	VSSOP	DGS	10	2500	366.0	364.0	50.0

TUBE

*All dimensions are nominal

Device	Package Name	Package Type	Pins	SPQ	L (mm)	W (mm)	T (μm)	B (mm)
DAC7554IDGS	DGS	VSSOP	10	80	330	6.55	500	2.88

DGS0010A



PACKAGE OUTLINE

VSSOP - 1.1 mm max height

SMALL OUTLINE PACKAGE



4221984/A 05/2015

NOTES:

1. All linear dimensions are in millimeters. Any dimensions in parenthesis are for reference only. Dimensioning and tolerancing per ASME Y14.5M.
2. This drawing is subject to change without notice.
3. This dimension does not include mold flash, protrusions, or gate burrs. Mold flash, protrusions, or gate burrs shall not exceed 0.15 mm per side.
4. This dimension does not include interlead flash. Interlead flash shall not exceed 0.25 mm per side.
5. Reference JEDEC registration MO-187, variation BA.

EXAMPLE BOARD LAYOUT

DGS0010A

VSSOP - 1.1 mm max height

SMALL OUTLINE PACKAGE



LAND PATTERN EXAMPLE
SCALE:10X



SOLDER MASK DETAILS
NOT TO SCALE

4221984/A 05/2015

NOTES: (continued)

- 6. Publication IPC-7351 may have alternate designs.
- 7. Solder mask tolerances between and around signal pads can vary based on board fabrication site.

EXAMPLE STENCIL DESIGN

DGS0010A

VSSOP - 1.1 mm max height

SMALL OUTLINE PACKAGE



SOLDER PASTE EXAMPLE
BASED ON 0.125 mm THICK STENCIL
SCALE:10X

4221984/A 05/2015

NOTES: (continued)

8. Laser cutting apertures with trapezoidal walls and rounded corners may offer better paste release. IPC-7525 may have alternate design recommendations.
9. Board assembly site may have different recommendations for stencil design.

IMPORTANT NOTICE AND DISCLAIMER

TI PROVIDES TECHNICAL AND RELIABILITY DATA (INCLUDING DATA SHEETS), DESIGN RESOURCES (INCLUDING REFERENCE DESIGNS), APPLICATION OR OTHER DESIGN ADVICE, WEB TOOLS, SAFETY INFORMATION, AND OTHER RESOURCES "AS IS" AND WITH ALL FAULTS, AND DISCLAIMS ALL WARRANTIES, EXPRESS AND IMPLIED, INCLUDING WITHOUT LIMITATION ANY IMPLIED WARRANTIES OF MERCHANTABILITY, FITNESS FOR A PARTICULAR PURPOSE OR NON-INFRINGEMENT OF THIRD PARTY INTELLECTUAL PROPERTY RIGHTS.

These resources are intended for skilled developers designing with TI products. You are solely responsible for (1) selecting the appropriate TI products for your application, (2) designing, validating and testing your application, and (3) ensuring your application meets applicable standards, and any other safety, security, regulatory or other requirements.

These resources are subject to change without notice. TI grants you permission to use these resources only for development of an application that uses the TI products described in the resource. Other reproduction and display of these resources is prohibited. No license is granted to any other TI intellectual property right or to any third party intellectual property right. TI disclaims responsibility for, and you will fully indemnify TI and its representatives against, any claims, damages, costs, losses, and liabilities arising out of your use of these resources.

TI's products are provided subject to [TI's Terms of Sale](#) or other applicable terms available either on [ti.com](https://www.ti.com) or provided in conjunction with such TI products. TI's provision of these resources does not expand or otherwise alter TI's applicable warranties or warranty disclaimers for TI products.

TI objects to and rejects any additional or different terms you may have proposed.

Mailing Address: Texas Instruments, Post Office Box 655303, Dallas, Texas 75265
Copyright © 2023, Texas Instruments Incorporated