

- Operates as a GTL-/GTL/GTL+ to LVTTTL or LVTTTL to GTL-/GTL/GTL+ Translator
- Series Termination on TTL Outputs of 30 Ω
- Latch-Up Testing Done to JEDEC Standard JESD 78
- ESD Performance Tested Per JESD 22
 - 2000-V Human-Body Model (A114-B, Class II)
 - 200-V Machine Model (A115-A)
 - 1000-V Charged-Device Model (C101)

**PW PACKAGE
(TOP VIEW)**

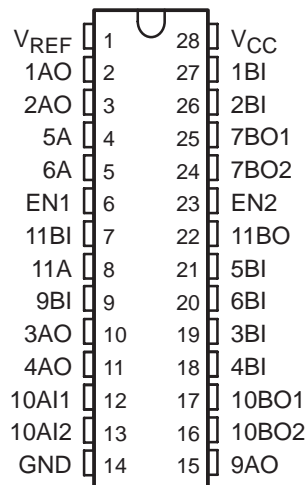

description/ordering information

The SN74GTL2007 is a 12-bit translator to interface between the 3.3-V LVTTTL chip set I/O and the Xeon™ processor GTL-/GTL/GTL+ I/O. The device is designed for platform health management in dual-processor applications.

PIN DESCRIPTION

PIN NUMBER	SYMBOL	NAME AND FUNCTION
1	VREF	GTL reference voltage
2-6, 8, 10-13, 15, 23	ENn nAn	Data and enable inputs/outputs (LVTTTL)
7, 9, 16, 17-22, 24-27	nBn	Data inputs/outputs (GTL-/GTL/GTL+)
14	GND	Ground (0 V)
28	VCC	Positive supply voltage

ORDERING INFORMATION

T _A	PACKAGE†	ORDERABLE PART NUMBER	TOP-SIDE MARKING
-40°C to 85°C	TSSOP – PW	Tube	GK2007
		Tape and reel	

† Package drawings, standard packing quantities, thermal data, symbolization, and PCB design guidelines are available at www.ti.com/sc/package.



Please be aware that an important notice concerning availability, standard warranty, and use in critical applications of Texas Instruments semiconductor products and disclaimers thereto appears at the end of this data sheet.

All trademarks are the property of their respective owners.

PRODUCTION DATA information is current as of publication date. Products conform to specifications per the terms of Texas Instruments standard warranty. Production processing does not necessarily include testing of all parameters.



POST OFFICE BOX 655303 • DALLAS, TEXAS 75265

Copyright © 2005, Texas Instruments Incorporated

SN74GTL2007

12-BIT GTL-/GTL/GTL+ TO LVTTL TRANSLATOR

SCLS609 – MARCH 2005

Function Tables

INPUTS		OUTPUT 1AO/2AO
EN1	1BI/2BI	
H	L	L
H	H	H
L	X	H

INPUTS		OUTPUT 3AO/4AO
EN2	3BI/4BI	
H	L	L
H	H	H
L	X	H

INPUT 9BI	OUTPUT 9AO
L	L
H	H

INPUTS		OUTPUT 10BO1/10BO2
10AI1/10AI2	9BI	
L	L	L
L	H	L
H	L	L
H	H	H

INPUTS		INPUT/OUTPUT 5A/6A (OPEN DRAIN)	OUTPUT 7BO1/7BO2
EN2	5BI/6BI		
H	L	L	H [†]
H	H	L [‡]	L
H	H	H	H
L	H	L [‡]	L
L	H	H	H
L	L	H	H
L	L	L [‡]	H

INPUT 11BI	INPUT/OUTPUT 11A (OPEN DRAIN)	OUTPUT 11BO
L	H	L
L	L [‡]	H
H	L	H

H = High voltage level

L = Low voltage level

[†] The enable on 7BO1/7BO2 includes a delay that prevents a transient condition (where 5BI/6BI goes from low to high, and the low to high on 5A/6A lags up to 100 ns) from causing a low glitch on the 7BO1/7BO2 outputs.

[‡] Open-drain input/output terminal is driven to a logic-low state by an external driver.



logic symbol

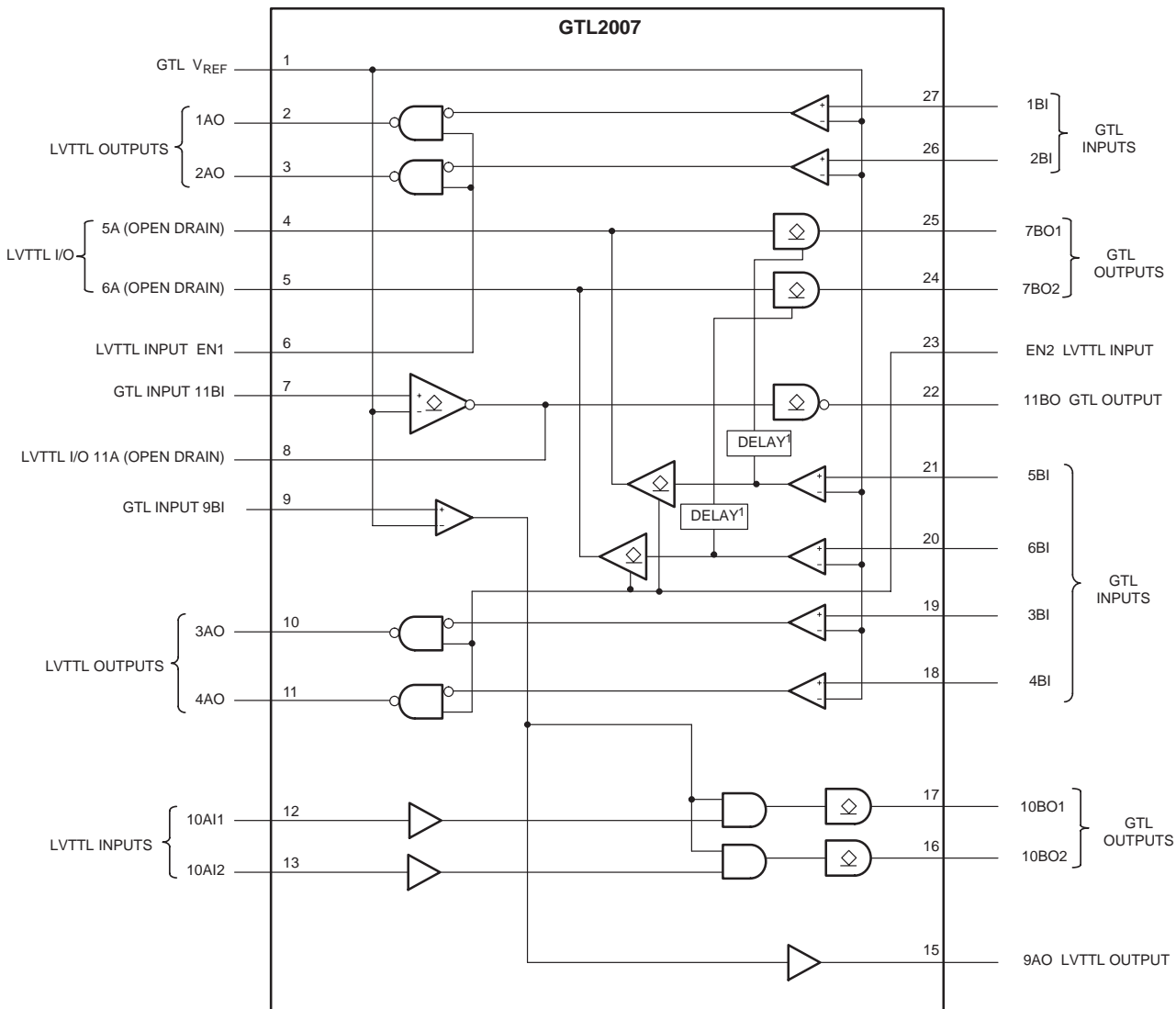

NOTE A: The enable on 7BO1/7BO2 includes a delay that prevents a transient condition (where 5BI/6BI go from low to high, and the low to high on 5A/6A lags up to 100 ns) from causing a low glitch on the 7BO1/7BO2 outputs.

SN74GTL2007

12-BIT GTL-/GTL/GTL+ TO LVTTTL TRANSLATOR

SCLS609 – MARCH 2005

absolute maximum ratings over operating free-air temperature (unless otherwise noted)†‡

Supply voltage range, V_{CC}	–0.5 to 4.6 V
Input voltage range, V_I (see Note 2): A port (LVTTTL)	–0.5 to 4.6 V
B port (GTL)	–0.5 to 4.6 V
Output voltage range, V_O (output in OFF or HIGH state)(see Note 2): A port	–0.5 to 4.6 V
B port	–0.5 to 4.6 V
Input diode current, I_{IK} ($V_I < 0$)	–50 mA
Output diode current, I_{OK} ($V_O < 0$)	–50 mA
Current into any output in the LOW state: A port	32 mA
B port	30 mA
Current into any output in the HIGH state, A port	–32 mA
Package thermal impedance, θ_{JA} (see Note 1)	62°C/W
Storage temperature range, T_{stg}	–60 to 150°C

† Stresses beyond those listed under “absolute maximum ratings” may cause permanent damage to the device. These are stress ratings only, and functional operation of the device at these or any other conditions beyond those indicated under “recommended operating conditions” is not implied. Exposure to absolute-maximum-rated conditions for extended periods may affect device reliability.

‡ Voltages are referenced to GND (ground = 0 V).

- NOTES: 1. The performance capability of a high-performance integrated circuit, in conjunction with its thermal environment, can create junction temperatures that are detrimental to reliability. The maximum junction temperature of this integrated circuit should not exceed 150°C.
2. The input and output negative voltage ratings may be exceeded if the input and output clamp current ratings are observed.

recommended operating conditions

		MIN	NOM	MAX	UNIT	
V_{CC}	Supply voltage	3	3.3	3.6	V	
V_{TT}	Termination voltage	GTL–	0.85	0.9	0.95	V
		GTL	1.14	1.2	1.26	
		GTL+	1.35	1.5	1.65	
V_{REF}	Reference voltage	Overall	0.5	$2/3 V_{TT}$	1.8	V
		GTL–	0.5	0.6	0.63	
		GTL	0.76	0.8	0.84	
		GTL+	0.87	1	1.1	
V_I	Input voltage	A port	0	3.3	3.6	V
		B port	0	V_{TT}	3.6	
V_{IH}	HIGH-level input voltage	A port	2			V
		B port	$V_{REF} + 50$ mV			
V_{IL}	LOW-level input voltage	A port		0.8		V
		B port		$V_{REF} - 50$ mV		
I_{OH}	HIGH-level output current			–16	mA	
I_{OL}	LOW-level output current	A port		16	mA	
		B port		15		
T_A	Operating free-air temperature range	–40		85	°C	



electrical characteristics over recommended operating conditions

PARAMETER		TEST CONDITIONS	-40°C TO +85°C			UNIT
			MIN	TYP†	MAX	
V _{OH} ‡	A port	V _{CC} = 3 V to 3.6 V, I _{OH} = -100 µA	V _{CC} - 0.2			V
		V _{CC} = 3 V, I _{OH} = -16 mA	2.1			
V _{OL} ‡	A port	V _{CC} = 3 V, I _{OL} = 16 mA	0.8			V
	B port	V _{CC} = 3 V, I _{OL} = 15 mA	0.4			
I _I	A port	V _{CC} = 3.6 V, V _I = V _{CC}	±1			µA
		V _{CC} = 3.6 V, V _I = 0 V	±1			
	B port	V _{CC} = 3.6 V, V _I = V _{TT} or GND	±1			
I _{CC}	A or B port	V _{CC} = 3.6 V, V _I = V _{CC} or GND, I _O = 0	12			mA
ΔI _{CC} §	A port or control inputs	V _{CC} = 3.6 V, V _I = V _{CC} - 0.6 V	500			µA
C _{IO}	A port	V _O = 3 V or 0	5			pF
	B port	V _O = V _{TT} or 0	4			

† All typical values are measured at V_{CC} = 3.3 V and T_A = 25°C.

‡ The input and output voltage ratings may be exceeded if the input and output current ratings are observed.

§ This is the increase in supply current for each input that is at the specified LVTTTL voltage, rather than V_{CC} or GND.

switching characteristics over recommended operating free-air temperature range

PARAMETER		WAVEFORM	GTL-			GTL			GTL+			UNIT
			V _{CC} = 3.3 V ± 0.3 V V _{REF} = 0.6 V			V _{CC} = 3.3 V ± 0.3 V V _{REF} = 0.8 V			V _{CC} = 3.3 V ± 0.3 V V _{REF} = 1 V			
			MIN	TYP†	MAX	MIN	TYP†	MAX	MIN	TYP†	MAX	
t _{PLH}	An to Bn	1	2	4	8	2	4	8	2	4	8	ns
t _{PHL}			2	5.5	10	2	5.5	10	2	5.5	10	
t _{PLH}	Bn to An	2	2	5.5	10	2	5.5	10	2	5.5	10	ns
t _{PHL}			2	5.5	10	2	5.5	10	2	5.5	10	
t _{PLH}	9BI to 10BOn	3	2	6	11	2	6	11	2	6	11	ns
t _{PHL}			2	6	11	2	6	11	2	6	11	
t _{PLH}	11BI to 11BO	3	2	8	13	2	8	13	2	8	13	ns
t _{PHL} ¶			2	14	21	2	14	21	2	14	21	
t _{PLH}	Bn to Bn	3	4	7	11	4	7	11	4	7	11	ns
t _{PHL}			120	205	350	120	205	350	120	205	350	
t _{PLH}	ENn to An	4	1	3	7	1	3	7	1	3	7	ns
t _{PHL}			1	3	7	1	3	7	1	3	7	
t _{PLZ}	Bn to An (I/O)	5	2	5	10	2	5	10	2	5	10	ns
t _{PZL}			2	5	10	2	5	10	2	5	10	
t _{PLZ}	EN2 to An (I/O)	6	1	3	7	1	3	7	1	3	7	ns
t _{PZL}			1	3	7	1	3	7	1	3	7	

† All typical values are measured at V_{CC} = 3.3 V and T_A = 25°C.

¶ Includes ~7.6-ns RC rise time of test-load pullup on 11-A, 1.5-kΩ pullup, and 21-pF load on 11 A has approximately 23-ns RC rise time.

SN74GTL2007

12-BIT GTL-/GTL/GTL+ TO LVTTTL TRANSLATOR

SCLS609 – MARCH 2005

PARAMETER MEASUREMENT INFORMATION

$V_{TT} = 1.2\text{ V}$, $V_{REF} = 0.8\text{ V}$ FOR GTL AND $V_{TT} = 1.5\text{ V}$, $V_{REF} = 1\text{ V}$ FOR GTL+

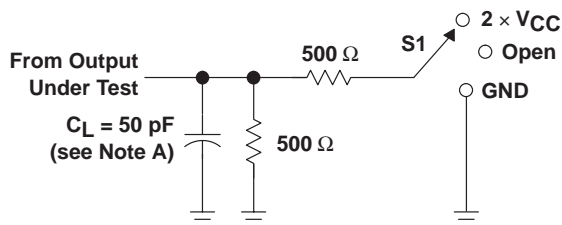

TEST	S1
t_{PLH}/t_{PHL}	Open
t_{PLZ}/t_{PZL}	$2 \times V_{CC}$

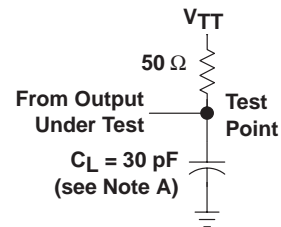

LOAD CIRCUIT FOR A OUTPUTS

LOAD CIRCUIT FOR B OUTPUTS

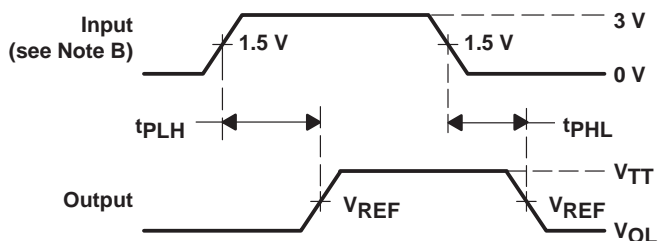

VOLTAGE WAVEFORM 1
PROPAGATION DELAY TIMES
(A port to B port)[†]

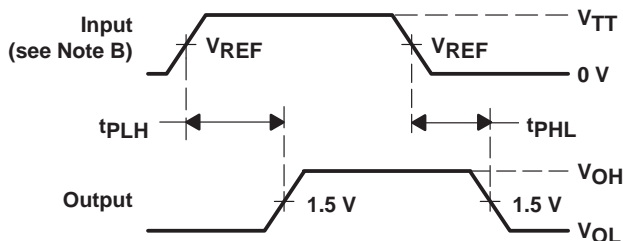

VOLTAGE WAVEFORM 2
PROPAGATION DELAY TIMES
(B port to A port)[†]

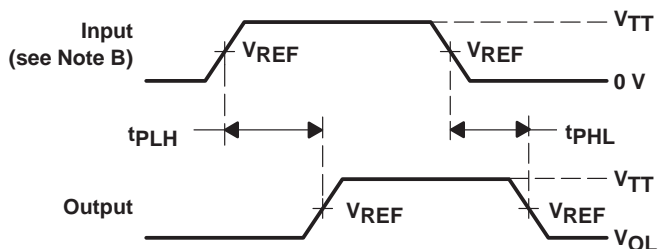

VOLTAGE WAVEFORM 3
PROPAGATION DELAY TIMES
(B port to B port)[†]

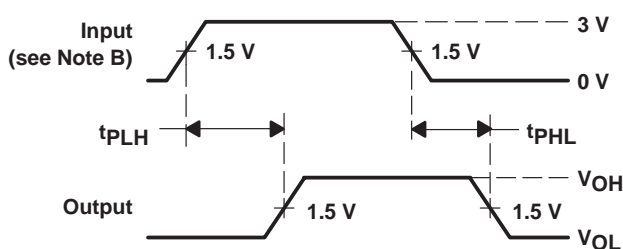

VOLTAGE WAVEFORM 4
PROPAGATION DELAY TIMES
(ENn to A port)[†]

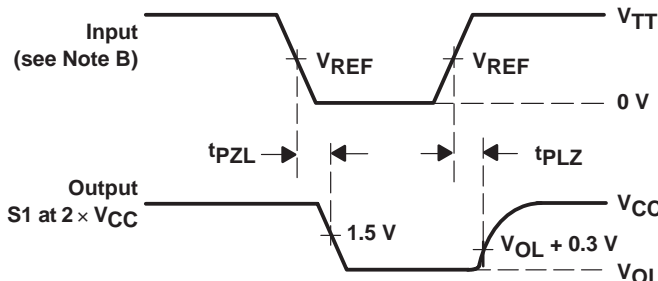

VOLTAGE WAVEFORM 5
PROPAGATION DELAY TIMES
(B port to A (I/O) port)[†]

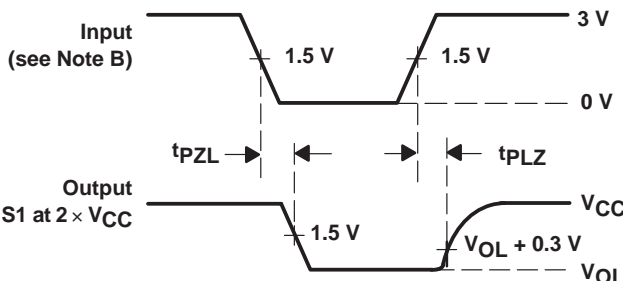

VOLTAGE WAVEFORM 6
ENABLE AND DISABLE TIMES
(EN2 to A (I/O) port)[†]

[†] All control inputs are LVTTTL levels.

NOTES: A. C_L includes probe and jig capacitance.

B. All input pulses are supplied by generators having the following characteristics: PRR $\leq 10\text{ MHz}$, $Z_O = 50\ \Omega$, $t_r \leq 2.5\text{ ns}$, $t_f \leq 2.5\text{ ns}$.

C. The outputs are measured one at a time, with one transition per measurement.

Figure 1. Load Circuits and Voltage Waveforms

APPLICATION INFORMATION

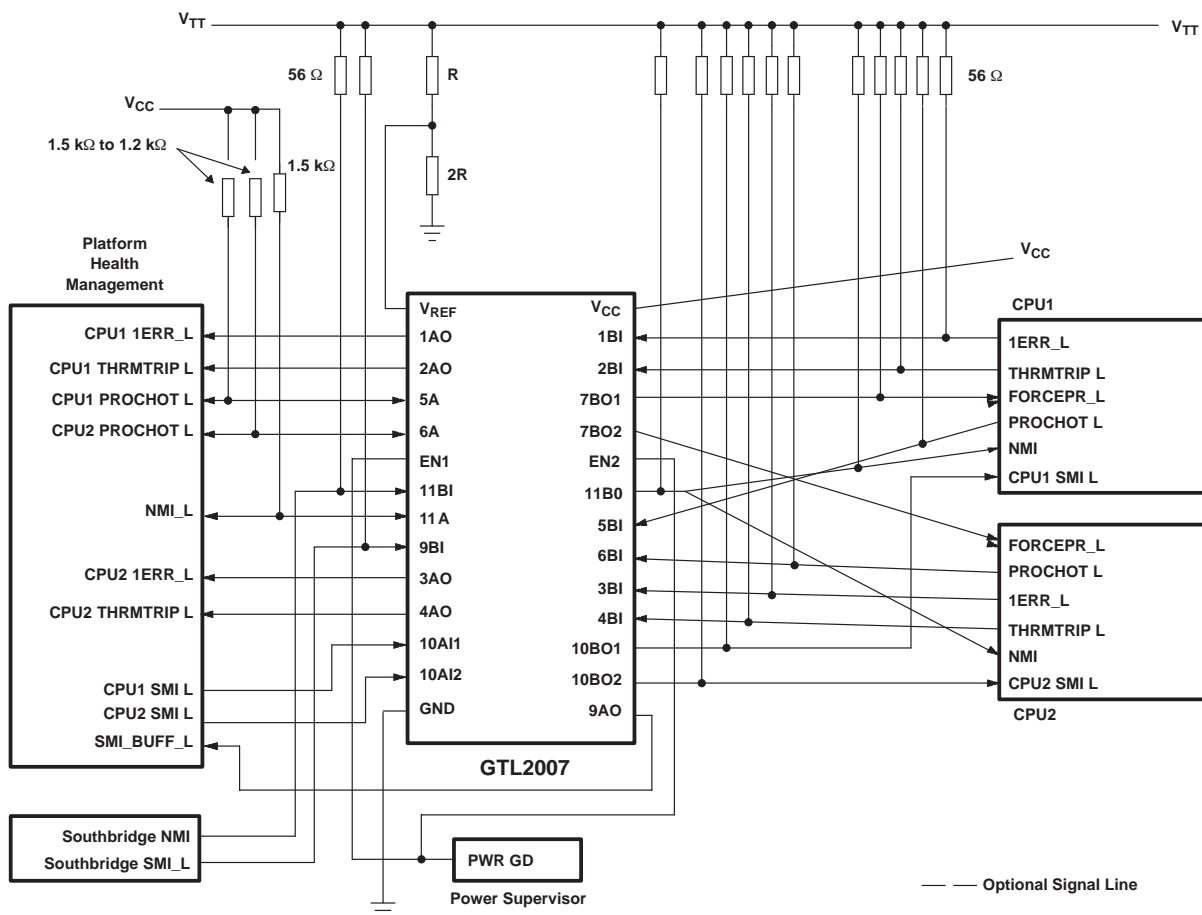

Frequently Asked Questions

Question 1: On the GTL2007 LVTTL input, specifically 10AI1 and 10AI2, when the GTL2007 is powered down, these inputs may be pulled up to 3.3 V, and we want to ensure that there is no leakage path to the power rail under this condition. Are the LVTTL inputs high impedance when the device is powered down, and will there be any leakage?

Answer 1: When the device is powered down, the LVTTL inputs are in a high-impedance state and do not leak to V_{DD} if they are pulled high while the device is powered down.

Question 2: Do all the LVTTL inputs have the same powered-down characteristic?

Answer 2: Yes

Question 3: What is the condition of the other GTL I/O and LVTTL output pins when the device is powered down?

Answer 3: The open-drain outputs, both GTL and LVTTL, do not leak to the power supply if they are pulled high while the device is powered down. The GTL inputs also do not leak to the power supply under the same conditions. The LVTTL totem-pole outputs, however, are not open-drain type outputs, and there is no current flow on these pins if they are pulled high when V_{DD} is at ground.

PACKAGING INFORMATION

Orderable Device	Status (1)	Package Type	Package Drawing	Pins	Package Qty	Eco Plan (2)	Lead finish/ Ball material (6)	MSL Peak Temp (3)	Op Temp (°C)	Device Marking (4/5)	Samples
SN74GTL2007PW	ACTIVE	TSSOP	PW	28	50	RoHS & Green	NIPDAU	Level-1-260C-UNLIM	-40 to 85	GK2007	Samples
SN74GTL2007PWR	ACTIVE	TSSOP	PW	28	2000	RoHS & Green	NIPDAU	Level-1-260C-UNLIM	-40 to 85	GK2007	Samples

(1) The marketing status values are defined as follows:

ACTIVE: Product device recommended for new designs.

LIFEBUY: TI has announced that the device will be discontinued, and a lifetime-buy period is in effect.

NRND: Not recommended for new designs. Device is in production to support existing customers, but TI does not recommend using this part in a new design.

PREVIEW: Device has been announced but is not in production. Samples may or may not be available.

OBSOLETE: TI has discontinued the production of the device.

(2) **RoHS:** TI defines "RoHS" to mean semiconductor products that are compliant with the current EU RoHS requirements for all 10 RoHS substances, including the requirement that RoHS substance do not exceed 0.1% by weight in homogeneous materials. Where designed to be soldered at high temperatures, "RoHS" products are suitable for use in specified lead-free processes. TI may reference these types of products as "Pb-Free".

RoHS Exempt: TI defines "RoHS Exempt" to mean products that contain lead but are compliant with EU RoHS pursuant to a specific EU RoHS exemption.

Green: TI defines "Green" to mean the content of Chlorine (Cl) and Bromine (Br) based flame retardants meet JS709B low halogen requirements of <=1000ppm threshold. Antimony trioxide based flame retardants must also meet the <=1000ppm threshold requirement.

(3) MSL, Peak Temp. - The Moisture Sensitivity Level rating according to the JEDEC industry standard classifications, and peak solder temperature.

(4) There may be additional marking, which relates to the logo, the lot trace code information, or the environmental category on the device.

(5) Multiple Device Markings will be inside parentheses. Only one Device Marking contained in parentheses and separated by a "~" will appear on a device. If a line is indented then it is a continuation of the previous line and the two combined represent the entire Device Marking for that device.

(6) Lead finish/Ball material - Orderable Devices may have multiple material finish options. Finish options are separated by a vertical ruled line. Lead finish/Ball material values may wrap to two lines if the finish value exceeds the maximum column width.

Important Information and Disclaimer:The information provided on this page represents TI's knowledge and belief as of the date that it is provided. TI bases its knowledge and belief on information provided by third parties, and makes no representation or warranty as to the accuracy of such information. Efforts are underway to better integrate information from third parties. TI has taken and continues to take reasonable steps to provide representative and accurate information but may not have conducted destructive testing or chemical analysis on incoming materials and chemicals. TI and TI suppliers consider certain information to be proprietary, and thus CAS numbers and other limited information may not be available for release.

In no event shall TI's liability arising out of such information exceed the total purchase price of the TI part(s) at issue in this document sold by TI to Customer on an annual basis.

TAPE AND REEL INFORMATION



QUADRANT ASSIGNMENTS FOR PIN 1 ORIENTATION IN TAPE



*All dimensions are nominal

Device	Package Type	Package Drawing	Pins	SPQ	Reel Diameter (mm)	Reel Width W1 (mm)	A0 (mm)	B0 (mm)	K0 (mm)	P1 (mm)	W (mm)	Pin1 Quadrant
SN74GTL2007PWR	TSSOP	PW	28	2000	330.0	16.4	6.9	10.2	1.8	12.0	16.0	Q1

TAPE AND REEL BOX DIMENSIONS

*All dimensions are nominal

Device	Package Type	Package Drawing	Pins	SPQ	Length (mm)	Width (mm)	Height (mm)
SN74GTL2007PWR	TSSOP	PW	28	2000	356.0	356.0	35.0

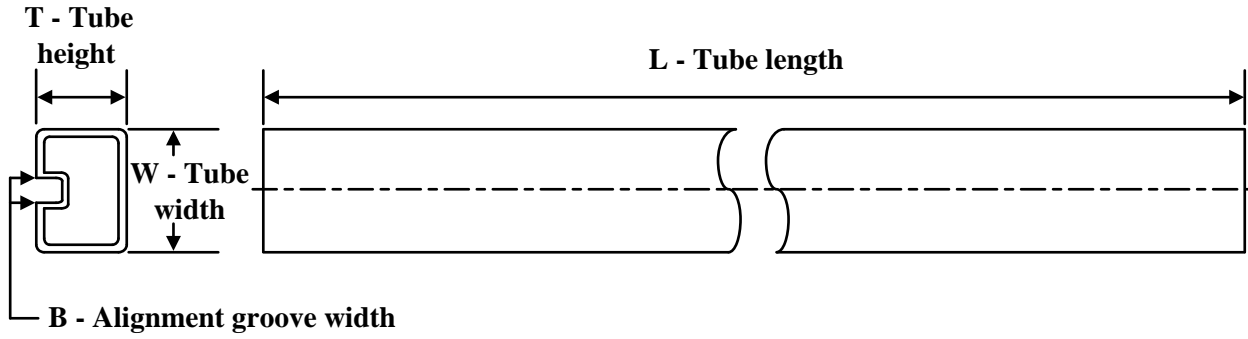
TUBE

*All dimensions are nominal

Device	Package Name	Package Type	Pins	SPQ	L (mm)	W (mm)	T (μm)	B (mm)
SN74GTL2007PW	PW	TSSOP	28	50	530	10.2	3600	3.5

MECHANICAL DATA

PW (R-PDSO-G28)

PLASTIC SMALL OUTLINE

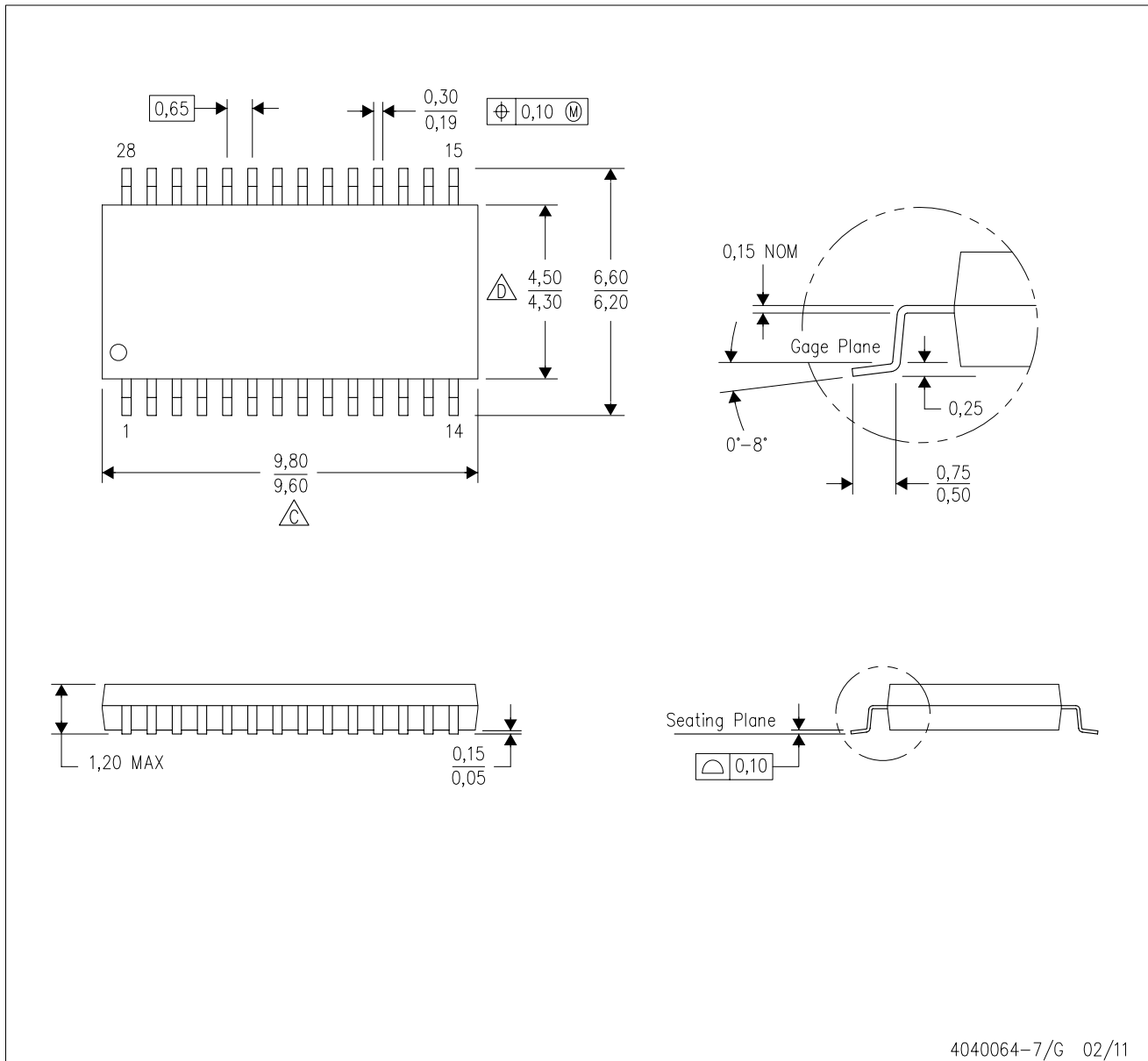

4040064-7/G 02/11

- NOTES:
- A. All linear dimensions are in millimeters. Dimensioning and tolerancing per ASME Y14.5M-1994.
 - B. This drawing is subject to change without notice.
 - C. Body length does not include mold flash, protrusions, or gate burrs. Mold flash, protrusions, or gate burrs shall not exceed 0,15 each side.
 - D. Body width does not include interlead flash. Interlead flash shall not exceed 0,25 each side.
 - E. Falls within JEDEC MO-153

PW (R-PDSO-G28)

PLASTIC SMALL OUTLINE

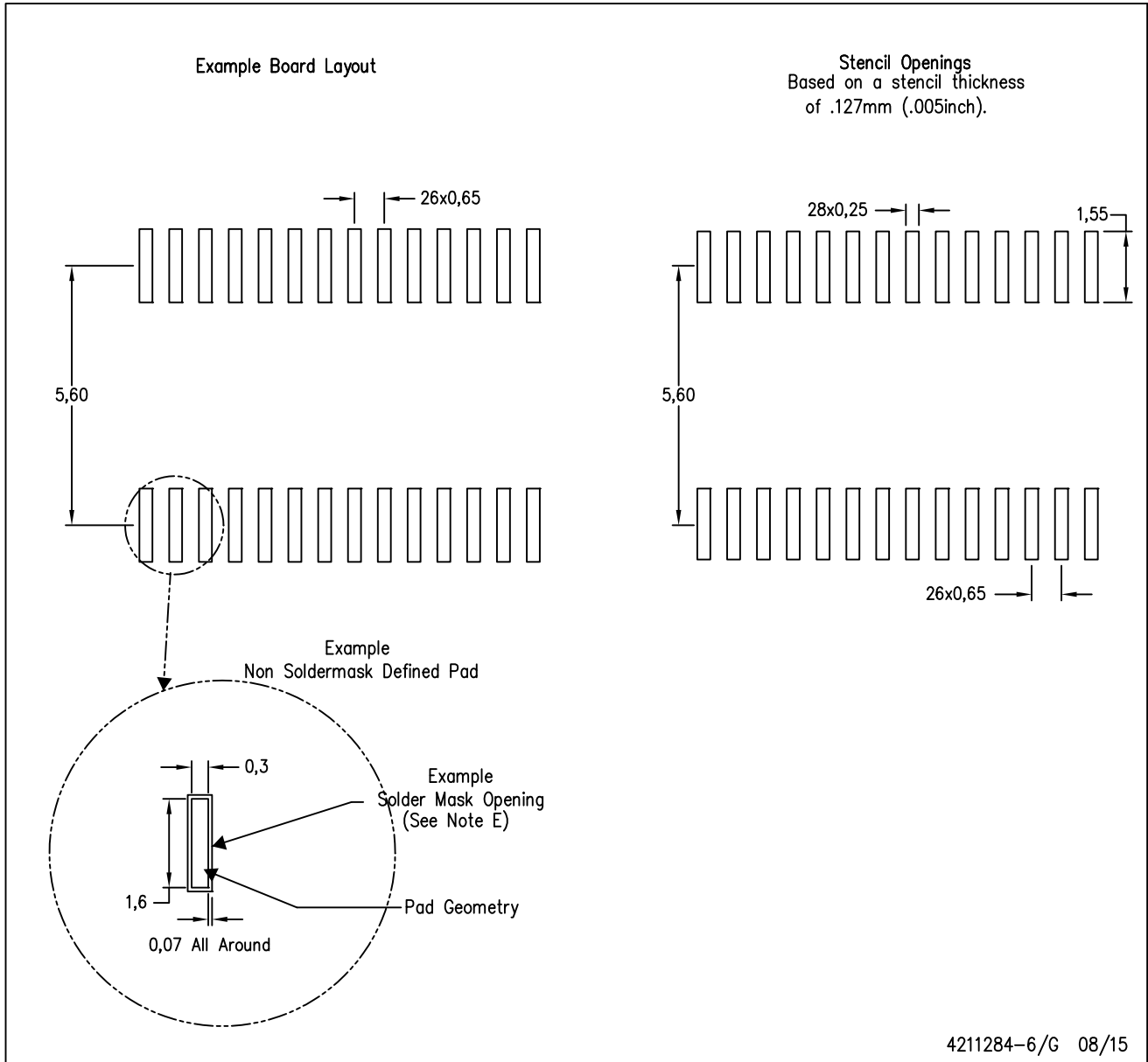

- NOTES:
- A. All linear dimensions are in millimeters.
 - B. This drawing is subject to change without notice.
 - C. Publication IPC-7351 is recommended for alternate design.
 - D. Laser cutting apertures with trapezoidal walls and also rounding corners will offer better paste release. Customers should contact their board assembly site for stencil design recommendations. Refer to IPC-7525 for other stencil recommendations.
 - E. Customers should contact their board fabrication site for solder mask tolerances between and around signal pads.

IMPORTANT NOTICE AND DISCLAIMER

TI PROVIDES TECHNICAL AND RELIABILITY DATA (INCLUDING DATA SHEETS), DESIGN RESOURCES (INCLUDING REFERENCE DESIGNS), APPLICATION OR OTHER DESIGN ADVICE, WEB TOOLS, SAFETY INFORMATION, AND OTHER RESOURCES "AS IS" AND WITH ALL FAULTS, AND DISCLAIMS ALL WARRANTIES, EXPRESS AND IMPLIED, INCLUDING WITHOUT LIMITATION ANY IMPLIED WARRANTIES OF MERCHANTABILITY, FITNESS FOR A PARTICULAR PURPOSE OR NON-INFRINGEMENT OF THIRD PARTY INTELLECTUAL PROPERTY RIGHTS.

These resources are intended for skilled developers designing with TI products. You are solely responsible for (1) selecting the appropriate TI products for your application, (2) designing, validating and testing your application, and (3) ensuring your application meets applicable standards, and any other safety, security, regulatory or other requirements.

These resources are subject to change without notice. TI grants you permission to use these resources only for development of an application that uses the TI products described in the resource. Other reproduction and display of these resources is prohibited. No license is granted to any other TI intellectual property right or to any third party intellectual property right. TI disclaims responsibility for, and you will fully indemnify TI and its representatives against, any claims, damages, costs, losses, and liabilities arising out of your use of these resources.

TI's products are provided subject to [TI's Terms of Sale](#) or other applicable terms available either on ti.com or provided in conjunction with such TI products. TI's provision of these resources does not expand or otherwise alter TI's applicable warranties or warranty disclaimers for TI products.

TI objects to and rejects any additional or different terms you may have proposed.

Mailing Address: Texas Instruments, Post Office Box 655303, Dallas, Texas 75265
Copyright © 2022, Texas Instruments Incorporated