

TLE2027, TLE2037, TLE2027A, TLE2037A, TLE2027Y, TLE2037Y EXCALIBUR LOW-NOISE HIGH-SPEED PRECISION OPERATIONAL AMPLIFIERS

SLOS192C – FEBRUARY 1997 – REVISED APRIL 2010

- **Outstanding Combination of dc Precision and AC Performance:**

Unity-Gain Bandwidth . . . 15 MHz Typ

V_n 3.3 nV/ $\sqrt{\text{Hz}}$ at $f = 10$ Hz Typ,
2.5 nV/ $\sqrt{\text{Hz}}$ at $f = 1$ kHz Typ

V_{IO} 25 μV Max

A_{VD} 45 V/ μV Typ With $R_L = 2$ k Ω ,
19 V/ μV Typ With $R_L = 600$ Ω

- Available in Standard-Pinout Small-Outline Package
- Output Features Saturation Recovery Circuitry
- Macromodels and Statistical information

description

The TLE20x7 and TLE20x7A contain innovative circuit design expertise and high-quality process control techniques to produce a level of ac performance and dc precision previously unavailable in single operational amplifiers. Manufactured using Texas Instruments state-of-the-art Excalibur process, these devices allow upgrades to systems that use lower-precision devices.

In the area of dc precision, the TLE20x7 and TLE20x7A offer maximum offset voltages of 100 μV and 25 μV , respectively, common-mode rejection ratio of 131 dB (typ), supply voltage rejection ratio of 144 dB (typ), and dc gain of 45 V/ μV (typ).

D, JG, OR P PACKAGE

(TOP VIEW)

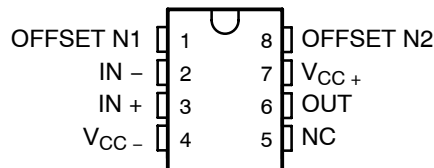

FK PACKAGE

(TOP VIEW)

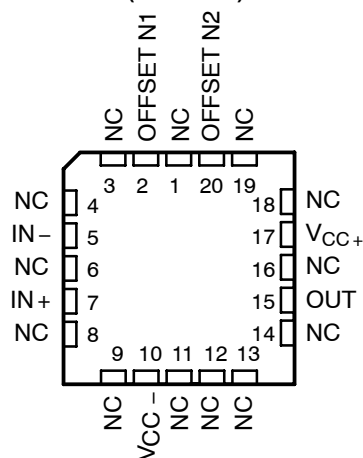

AVAILABLE OPTIONS

| T_A | V_{IOmax} AT 25°C | PACKAGED DEVICES | | | | CHIP FORM [‡] (Y) |
|----------------|---------------------|--------------------------------|----------------------------|----------------------------|--------------------------|----------------------------|
| | | SMALL OUTLINE [†] (D) | CHIP CARRIER (FK) | CERAMIC DIP (JG) | PLASTIC DIP (P) | |
| 0°C to 70°C | 25 μV | TLE2027ACD TLE2037ACD | — — | — — | TLE2027ACP TLE2037ACP | TLE2027Y TLE2037Y |
| | 100 μV | TLE2027CD TLE2037CD | — — | — — | TLE2027CP TLE2037CP | TLE2027Y TLE2037Y |
| -40°C to 105°C | 25 μV | TLE2027AID TLE2037AID | — — | — — | TLE2027AIP TLE2037AIP | — |
| | 100 μV | TLE2027ID TLE2037ID | — — | — — | TLE2027IP TLE2037IP | — |
| -55°C to 125°C | 25 μV | TLE2027AMD TLE2037AMD | TLE2027AMFK TLE2037AMFK | TLE2027AMJG TLE2037AMJG | TLE2027AMP TLE2037AMP | — |
| | 100 μV | TLE2027MD TLE2037MD | TLE2027MFK TLE2037MFK | TLE2027MJG TLE2037MJG | TLE2027MP TLE2037MP | — |

[†] The D packages are available taped and reeled. Add R suffix to device type (e.g., TLE2027ACDR).

[‡] Chip forms are tested at 25°C only.



Please be aware that an important notice concerning availability, standard warranty, and use in critical applications of Texas Instruments semiconductor products and disclaimers thereto appears at the end of this data sheet.

All trademarks are the property of their respective owners.

PRODUCTION DATA information is current as of publication date. Products conform to specifications per the terms of Texas Instruments standard warranty. Production processing does not necessarily include testing of all parameters.



Copyright © 2002–2006, Texas Instruments Incorporated

TLE2027, TLE2037, TLE2027A, TLE2037A, TLE2027Y, TLE2037Y EXCALIBUR LOW-NOISE HIGH-SPEED PRECISION OPERATIONAL AMPLIFIERS

SLOS192C – FEBRUARY 1997 – REVISED APRIL 2010

description (continued)

The ac performance of the TLE2027 and TLE2037 is highlighted by a typical unity-gain bandwidth specification of 15 MHz, 55° of phase margin, and noise voltage specifications of 3.3 nV/ $\sqrt{\text{Hz}}$ and 2.5 nV/ $\sqrt{\text{Hz}}$ at frequencies of 10 Hz and 1 kHz respectively. The TLE2037 and TLE2037A have been decompensated for faster slew rate ($-7.5 \text{ V}/\mu\text{s}$, typical) and wider bandwidth (50 MHz). To ensure stability, the TLE2037 and TLE2037A should be operated with a closed-loop gain of 5 or greater.

Both the TLE20x7 and TLE20x7A are available in a wide variety of packages, including the industry-standard 8-pin small-outline version for high-density system applications. The C-suffix devices are characterized for operation from 0°C to 70°C. The I-suffix devices are characterized for operation from -40°C to 105°C. The M-suffix devices are characterized for operation over the full military temperature range of -55°C to 125°C.

symbol

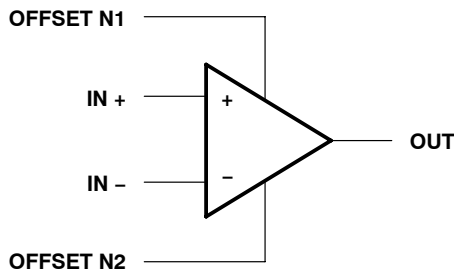

TLE2027, TLE2037, TLE2027A, TLE2037A, TLE2027Y, TLE2037Y
EXCALIBUR LOW-NOISE HIGH-SPEED
PRECISION OPERATIONAL AMPLIFIERS

SLOS192C – FEBRUARY 1997 – REVISED APRIL 2010

TLE202xY chip information

This chip, when properly assembled, displays characteristics similar to the TLE202xC. Thermal compression or ultrasonic bonding may be used on the doped-aluminum bonding pads. The chip may be mounted with conductive epoxy or a gold-silicon preform.

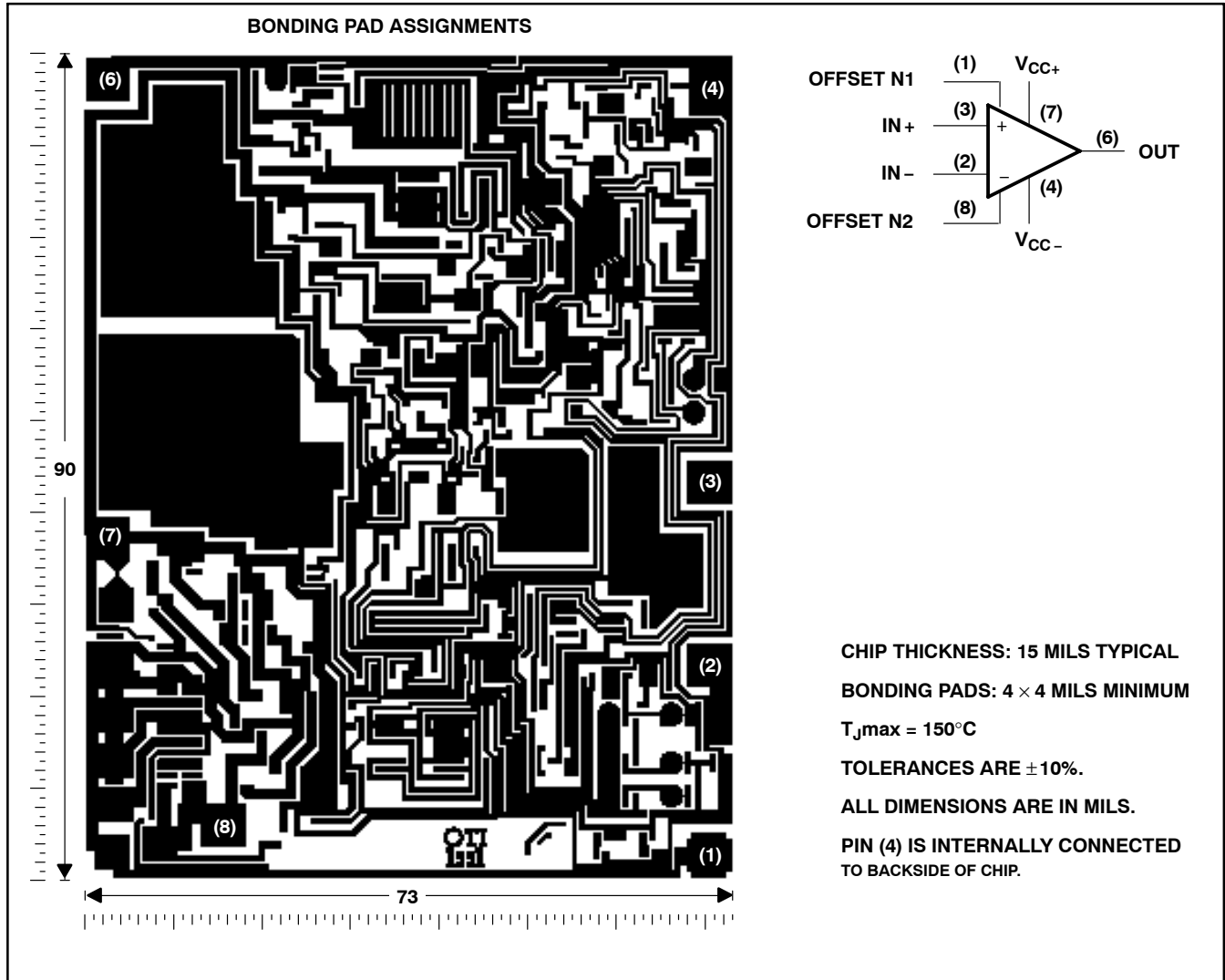

TLE2027, TLE2037, TLE2027A, TLE2037A, TLE2027Y, TLE2037Y
EXCALIBUR LOW-NOISE HIGH-SPEED
PRECISION OPERATIONAL AMPLIFIERS
 SLOS192C – FEBRUARY 1997 – REVISED APRIL 2010

equivalent schematic

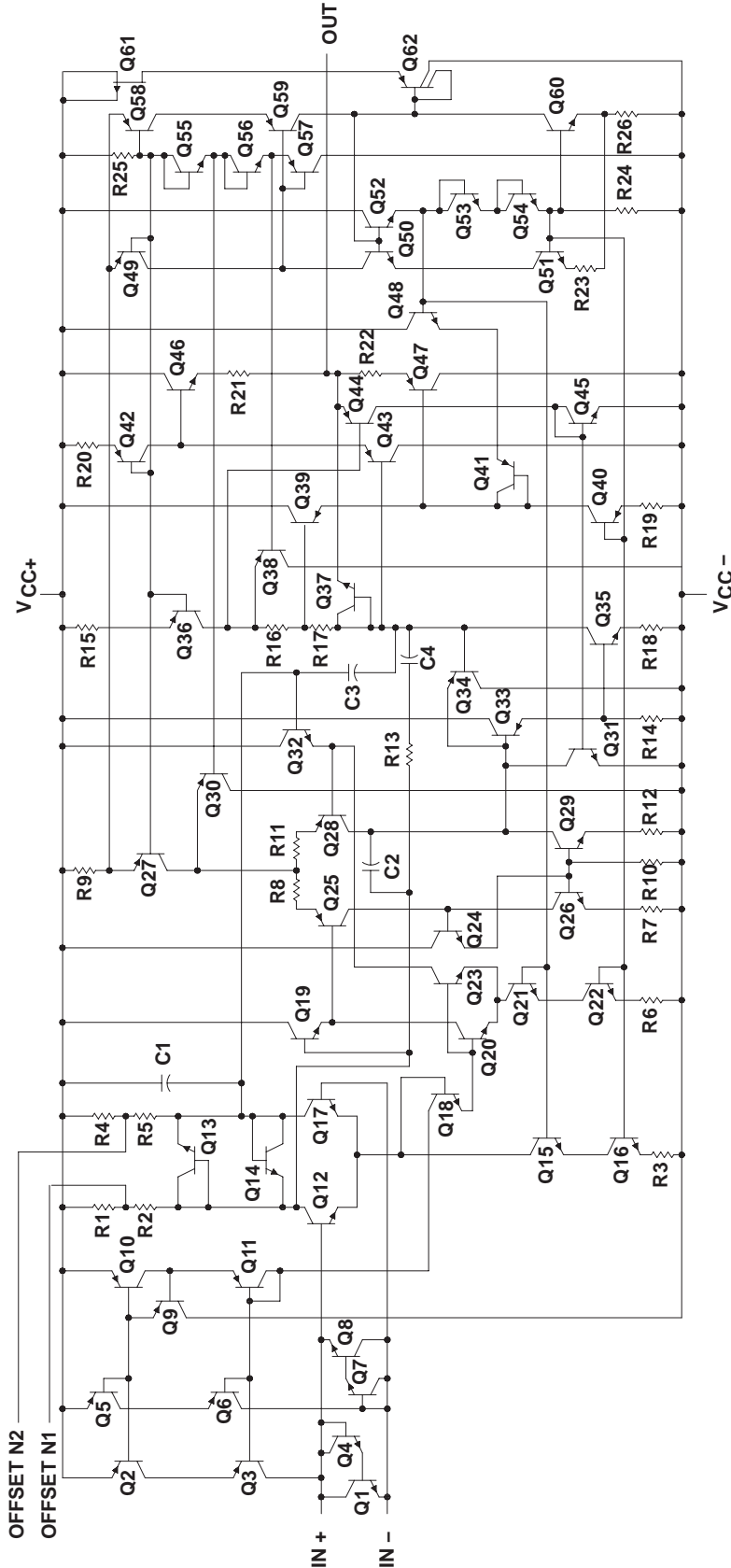

| ACTUAL DEVICE COMPONENT COUNT | | |
|-------------------------------|---------|---------|
| COMPONENT | TLE2027 | TLE2037 |
| Transistors | 61 | 61 |
| Resistors | 26 | 26 |
| epiFET | 1 | 1 |
| Capacitors | 4 | 4 |

TLE2027, TLE2037, TLE2027A, TLE2037A, TLE2027Y, TLE2037Y EXCALIBUR LOW-NOISE HIGH-SPEED PRECISION OPERATIONAL AMPLIFIERS

SLOS192C – FEBRUARY 1997 – REVISED APRIL 2010

absolute maximum ratings over operating free-air temperature range (unless otherwise noted)[†]

| | |
|--|------------------------------|
| Supply voltage, V_{CC+} (see Note 1) | 19 V |
| Supply voltage, V_{CC-} | - 19 V |
| Differential input voltage, V_{ID} (see Note 2) | ± 1.2 V |
| Input voltage range, V_I (any input) | $V_{CC\pm}$ |
| Input current, I_I (each Input) | ± 1 mA |
| Output current, I_O | ± 50 mA |
| Total current into V_{CC+} | 50 mA |
| Total current out of V_{CC-} | 50 mA |
| Duration of short-circuit current at (or below) 25°C (see Note 3) | unlimited |
| Continuous total power dissipation | See Dissipation Rating Table |
| Operating free-air temperature range, T_A : C suffix | 0°C to 70°C |
| I suffix | - 40°C to 105°C |
| M suffix | - 55°C to 125°C |
| Storage temperature range, T_{stg} | - 65°C to 150°C |
| Case temperature for 60 seconds, T_C : FK package | 260°C |
| Lead temperature 1,6 mm (1/16 inch) from case for 10 seconds: D or P package | 260°C |
| Lead temperature 1,6 mm (1/16 inch) from case for 60 seconds: JG package | 300°C |

[†] Stresses beyond those listed under “absolute maximum ratings” may cause permanent damage to the device. These are stress ratings only, and functional operation of the device at these or any other conditions beyond those indicated under “recommended operating conditions” is not implied. Exposure to absolute-maximum-rated conditions for extended periods may affect device reliability.

- NOTES:
- All voltage values, except differential voltages, are with respect to the midpoint between V_{CC+} and V_{CC-} .
 - Differential voltages are at $IN+$ with respect to $IN-$. Excessive current flows if a differential input voltage in excess of approximately ± 1.2 V is applied between the inputs unless some limiting resistance is used.
 - The output may be shorted to either supply. Temperature and/or supply voltages must be limited to ensure that the maximum dissipation rating is not exceeded.

DISSIPATION RATING TABLE

| PACKAGE | $T_A \leq 25^\circ\text{C}$ | DERATING FACTOR ABOVE $T_A = 25^\circ\text{C}$ | $T_A = 70^\circ\text{C}$ | $T_A = 105^\circ\text{C}$ | $T_A = 125^\circ\text{C}$ |
|---------|-----------------------------|---|--------------------------|---------------------------|---------------------------|
| | POWER RATING | | POWER RATING | POWER RATING | POWER RATING |
| D | 725 mW | 5.8 mW/°C | 464 mW | 261 mW | 145 mW |
| FK | 1375 mW | 11.0 mW/°C | 880 mW | 495 mW | 275 mW |
| JG | 1050 mW | 8.4 mW/°C | 672 mW | 378 mW | 210 mW |
| P | 1000 mW | 8.0 mW/°C | 640 mW | 360 mW | 200 mW |

recommended operating conditions

| | | C SUFFIX | | I SUFFIX | | M SUFFIX | | UNIT |
|---------------------------------------|------------------------------------|----------|----------|----------|----------|----------|----------|------|
| | | MIN | MAX | MIN | MAX | MIN | MAX | |
| Supply voltage, $V_{CC\pm}$ | | ± 4 | ± 19 | ± 4 | ± 19 | ± 4 | ± 19 | V |
| Common-mode input voltage, V_{IC} | $T_A = 25^\circ\text{C}$ | - 11 | 11 | - 11 | 11 | - 11 | 11 | V |
| | $T_A = \text{Full range}^\ddagger$ | - 10.5 | 10.5 | - 10.4 | 10.4 | - 10.2 | 10.2 | |
| Operating free-air temperature, T_A | | 0 | 70 | - 40 | 105 | - 55 | 125 | °C |

[‡] Full range is 0°C to 70°C for C-suffix devices, - 40°C to 105°C for I-suffix devices, and - 55°C to 125°C for M-suffix devices.

TLE2027, TLE2037, TLE2027A, TLE2037A, TLE2027Y, TLE2037Y EXCALIBUR LOW-NOISE HIGH-SPEED PRECISION OPERATIONAL AMPLIFIERS

SLOS192C – FEBRUARY 1997 – REVISED APRIL 2010

TLE20x7C electrical characteristics at specified free-air temperature, $V_{CC\pm} = \pm 15\text{ V}$ (unless otherwise noted)

| PARAMETER | TEST CONDITIONS | T_A^\dagger | TLE20x7C | | | TLE20x7AC | | | UNIT |
|---|--|---------------|---------------|-----------|-----|---------------|-----------|------------------------------|------|
| | | | MIN | TYP | MAX | MIN | TYP | MAX | |
| V_{IO} Input offset voltage | $V_{IC} = 0, R_S = 50\ \Omega$ | 25°C | 20 | 100 | | 10 | 25 | μV | |
| | | Full range | | | 145 | | 70 | | |
| α_{VIO} Temperature coefficient of input offset voltage | | Full range | 0.4 | 1 | | 0.2 | 1 | $\mu\text{V}/^\circ\text{C}$ | |
| Input offset voltage long-term drift (see Note 4) | | 25°C | 0.006 | 1 | | 0.006 | 1 | $\mu\text{V}/\text{mo}$ | |
| I_{IO} Input offset current | | 25°C | 6 | 90 | | 6 | 90 | nA | |
| | | Full range | | | 150 | | 150 | | |
| I_{IB} Input bias current | 25°C | 15 | 90 | | 15 | 90 | nA | | |
| | Full range | | | 150 | | 150 | | | |
| V_{ICR} Common-mode input voltage range | $R_S = 50\ \Omega$ | 25°C | -11 to 11 | -13 to 13 | | -11 to 11 | -13 to 13 | V | |
| | | Full range | -10.5 to 10.5 | | | -10.5 to 10.5 | | | |
| V_{OM+} Maximum positive peak output voltage swing | $R_L = 600\ \Omega$ | 25°C | 10.5 | 12.9 | | 10.5 | 12.9 | V | |
| | | Full range | 10 | | | 10 | | | |
| | $R_L = 2\ \text{k}\Omega$ | 25°C | 12 | 13.2 | | 12 | 13.2 | | |
| | | Full range | 11 | | | 11 | | | |
| V_{OM-} Maximum negative peak output voltage swing | $R_L = 600\ \Omega$ | 25°C | -10.5 | -13 | | -10.5 | -13 | V | |
| | | Full range | -10 | | | -10 | | | |
| | $R_L = 2\ \text{k}\Omega$ | 25°C | -12 | -13.5 | | -12 | -13.5 | | |
| | | Full range | -11 | | | -11 | | | |
| A_{VD} Large-signal differential voltage amplification | $V_O = \pm 11\ \text{V}, R_L = 2\ \text{k}\Omega$ | 25°C | 5 | 45 | | 10 | 45 | $\text{V}/\mu\text{V}$ | |
| | | Full range | 2 | | | 4 | | | |
| | $V_O = \pm 10\ \text{V}, R_L = 2\ \text{k}\Omega$ | 25°C | 3.5 | 38 | | 8 | 38 | | |
| | | Full range | 1 | | | 2.5 | | | |
| | $V_O = \pm 10\ \text{V}, R_L = 600\ \Omega$ | 25°C | 2 | 19 | | 5 | 19 | | |
| | | Full range | 0.5 | | | 2 | | | |
| C_i Input capacitance | | 25°C | 8 | | 8 | | pF | | |
| z_o Open-loop output impedance | $I_O = 0$ | 25°C | 50 | | 50 | | Ω | | |
| CMRR Common-mode rejection ratio | $V_{IC} = V_{ICRmin}, R_S = 50\ \Omega$ | 25°C | 100 | 131 | | 117 | 131 | dB | |
| | | Full range | 98 | | | 114 | | | |
| k_{SVR} Supply-voltage rejection ratio ($\Delta V_{CC\pm} / \Delta V_{IO}$) | $V_{CC\pm} = \pm 4\ \text{V to } \pm 18\ \text{V}, R_S = 50\ \Omega$ | 25°C | 94 | 144 | | 110 | 144 | dB | |
| | $V_{CC\pm} = \pm 4\ \text{V to } \pm 18\ \text{V}, R_S = 50\ \Omega$ | Full range | 92 | | | 106 | | | |
| I_{CC} Supply current | $V_O = 0, \text{ No load}$ | 25°C | 3.8 | 5.3 | | 3.8 | 5.3 | mA | |
| | | Full range | | | 5.6 | | 5.6 | | |

† Full range is 0°C to 70°C.

NOTE 4: Typical values are based on the input offset voltage shift observed through 168 hours of operating life test at $T_A = 150^\circ\text{C}$ extrapolated to $T_A = 25^\circ\text{C}$ using the Arrhenius equation and assuming an activation energy of 0.96 eV.

TLE2027, TLE2037, TLE2027A, TLE2037A, TLE2027Y, TLE2037Y
EXCALIBUR LOW-NOISE HIGH-SPEED
PRECISION OPERATIONAL AMPLIFIERS

SLOS192C – FEBRUARY 1997 – REVISED APRIL 2010

TLE20x7C operating characteristics at specified free-air temperature, $V_{CC} \pm = \pm 15\text{ V}$, $T_A = 25^\circ\text{C}$ (unless otherwise specified)

| PARAMETER | TEST CONDITIONS | | TLE20x7C | | | TLE20x7AC | | | UNIT |
|---|--|---------|------------------|-----|-----|------------------|-----|------------------|------------------------|
| | | | MIN | TYP | MAX | MIN | TYP | MAX | |
| SR Slew rate at unity gain | $R_L = 2\text{ k}\Omega$, $C_L = 100\text{ pF}$, See Figure 1 | TLE2027 | 1.7 | 2.8 | | 1.7 | 2.8 | V/ μs | |
| | | TLE2037 | 6 | 7.5 | | 6 | 7.5 | | |
| | $R_L = 2\text{ k}\Omega$, $C_L = 100\text{ pF}$, $T_A = 0^\circ\text{C}$ to 70°C , See Figure 1 | TLE2027 | 1.2 | | | 1.2 | | | |
| | | TLE2037 | 5 | | | 5 | | | |
| V_n Equivalent input noise voltage (see Figure 2) | $R_S = 20\ \Omega$, $f = 10\text{ Hz}$ | | | 3.3 | 8 | | 3.3 | 4.5 | nV/ $\sqrt{\text{Hz}}$ |
| | $R_S = 20\ \Omega$, $f = 1\text{ kHz}$ | | | 2.5 | 4.5 | | 2.5 | 3.8 | |
| $V_{N(PP)}$ Peak-to-peak equivalent input noise voltage | $f = 0.1\text{ Hz}$ to 10 Hz | | | 50 | 250 | | 50 | 130 | nV |
| I_n Equivalent input noise current | $f = 10\text{ Hz}$ | | | 10 | 25 | | 10 | 25 | pA/ $\sqrt{\text{Hz}}$ |
| | $f = 1\text{ kHz}$ | | | 0.8 | 1.8 | | 0.8 | 1.8 | |
| THD Total harmonic distortion | $V_O = +10\text{ V}$, $A_{VD} = 1$, See Note 5 | TLE2027 | <0.002% | | | <0.002% | | | |
| | $V_O = +10\text{ V}$, $A_{VD} = 5$, See Note 5 | TLE2037 | <0.002% | | | <0.002% | | | |
| B_1 Unity-gain bandwidth (see Figure 3) | $R_L = 2\text{ k}\Omega$, $C_L = 100\text{ pF}$ | TLE2027 | 9 ⁽⁶⁾ | 13 | | 9 ⁽⁶⁾ | 13 | MHz | |
| GBW Gain bandwidth product | $R_L = 2\text{ k}\Omega$, $C_L = 100\text{ pF}$ | TLE2037 | 35 | 50 | | 35 | 50 | | |
| B_{OM} Maximum output-swing bandwidth | $R_L = 2\text{ k}\Omega$ | TLE2027 | 30 | | | 30 | | | kHz |
| | | TLE2037 | 80 | | | 80 | | | |
| ϕ_m Phase margin at unity gain (see Figure 3) | $R_L = 2\text{ k}\Omega$, $C_L = 100\text{ pF}$ | TLE2027 | 55° | | | 55° | | | |
| | | TLE2037 | 50° | | | 50° | | | |

NOTE 5: Measured distortion of the source used in the analysis was 0.002%.

NOTE 6: This parameter is not production tested

TLE2027, TLE2037, TLE2027A, TLE2037A, TLE2027Y, TLE2037Y EXCALIBUR LOW-NOISE HIGH-SPEED PRECISION OPERATIONAL AMPLIFIERS

SLOS192C – FEBRUARY 1997 – REVISED APRIL 2010

TLE20x7I electrical characteristics at specified free-air temperature, $V_{CC\pm} = \pm 15\text{ V}$ (unless otherwise noted)

| PARAMETER | TEST CONDITIONS | T_A^\dagger | TLE20x7I | | | TLE20x7AI | | | UNIT |
|---|--|---------------|---------------|-----------|-----|---------------|-----------|------------------------------|------|
| | | | MIN | TYP | MAX | MIN | TYP | MAX | |
| V_{IO} Input offset voltage | $V_{IC} = 0, R_S = 50\ \Omega$ | 25°C | 20 | 100 | | 10 | 25 | μV | |
| | | Full range | | | 180 | | 105 | | |
| α_{VIO} Temperature coefficient of input offset voltage | | Full range | 0.4 | 1 | | 0.2 | 1 | $\mu\text{V}/^\circ\text{C}$ | |
| Input offset voltage long-term drift (see Note 4) | | 25°C | 0.006 | 1 | | 0.006 | 1 | $\mu\text{V}/\text{mo}$ | |
| I_{IO} Input offset current | | 25°C | 6 | 90 | | 6 | 90 | nA | |
| | | Full range | | | 150 | | 150 | | |
| I_{IB} Input bias current | 25°C | 15 | 90 | | 15 | 90 | nA | | |
| | Full range | | | 150 | | 150 | | | |
| V_{ICR} Common-mode input voltage range | $R_S = 50\ \Omega$ | 25°C | -11 to 11 | -13 to 13 | | -11 to 11 | -13 to 13 | V | |
| | | Full range | -10.4 to 10.4 | | | -10.4 to 10.4 | | | |
| V_{OM+} Maximum positive peak output voltage swing | $R_L = 600\ \Omega$ | 25°C | 10.5 | 12.9 | | 10.5 | 12.9 | V | |
| | | Full range | 10 | | | 10 | | | |
| | $R_L = 2\ \text{k}\Omega$ | 25°C | 12 | 13.2 | | 12 | 13.2 | | |
| | | Full range | 11 | | | 11 | | | |
| V_{OM-} Maximum negative peak output voltage swing | $R_L = 600\ \Omega$ | 25°C | -10.5 | -13 | | -10.5 | -13 | V | |
| | | Full range | -10 | | | -10 | | | |
| | $R_L = 2\ \text{k}\Omega$ | 25°C | -12 | -13.5 | | -12 | -13.5 | | |
| | | Full range | -11 | | | -11 | | | |
| A_{VD} Large-signal differential voltage amplification | $V_O = \pm 11\ \text{V}, R_L = 2\ \text{k}\Omega$ | 25°C | 5 | 45 | | 10 | 45 | $\text{V}/\mu\text{V}$ | |
| | $V_O = \pm 10\ \text{V}, R_L = 2\ \text{k}\Omega$ | Full range | 2 | | | 3.5 | | | |
| | $V_O = \pm 10\ \text{V}, R_L = 1\ \text{k}\Omega$ | 25°C | 3.5 | 38 | | 8 | 38 | | |
| | | Full range | 1 | | | 2.2 | | | |
| | $V_O = \pm 10\ \text{V}, R_L = 600\ \Omega$ | 25°C | 2 | 19 | | 5 | 19 | | |
| | | Full range | 0.5 | | | 1.1 | | | |
| C_i Input capacitance | | 25°C | 8 | | 8 | | pF | | |
| z_o Open-loop output impedance | $I_O = 0$ | 25°C | 50 | | 50 | | Ω | | |
| CMRR Common-mode rejection ratio | $V_{IC} = V_{ICRmin}, R_S = 50\ \Omega$ | 25°C | 100 | 131 | | 117 | 131 | dB | |
| | | Full range | 96 | | | 113 | | | |
| k_{SVR} Supply-voltage rejection ratio ($\Delta V_{CC\pm} / \Delta V_{IO}$) | $V_{CC\pm} = \pm 4\ \text{V to } \pm 18\ \text{V}, R_S = 50\ \Omega$ | 25°C | 94 | 144 | | 110 | 144 | dB | |
| | $V_{CC\pm} = \pm 4\ \text{V to } \pm 18\ \text{V}, R_S = 50\ \Omega$ | Full range | 90 | | | 105 | | | |
| I_{CC} Supply current | $V_O = 0, \text{ No load}$ | 25°C | 3.8 | 5.3 | | 3.8 | 5.3 | mA | |
| | | Full range | | | 5.6 | | 5.6 | | |

† Full range is -40°C to 105°C .

NOTE 4: Typical values are based on the input offset voltage shift observed through 168 hours of operating life test at $T_A = 150^\circ\text{C}$ extrapolated to $T_A = 25^\circ\text{C}$ using the Arrhenius equation and assuming an activation energy of 0.96 eV.

TLE2027, TLE2037, TLE2027A, TLE2037A, TLE2027Y, TLE2037Y
EXCALIBUR LOW-NOISE HIGH-SPEED
PRECISION OPERATIONAL AMPLIFIERS

SLOS192C – FEBRUARY 1997 – REVISED APRIL 2010

TLE20x7I operating characteristics at specified free-air temperature, $V_{CC\pm} = \pm 15\text{ V}$, $T_A = 25^\circ\text{C}$ (unless otherwise specified)

| PARAMETER | TEST CONDITIONS | | TLE20x7I | | | TLE20x7AI | | | UNIT |
|-------------|---|--|----------|------------------|-----|-----------|------------------|-----|------------------------|
| | | | MIN | TYP | MAX | MIN | TYP | MAX | |
| SR | Slew rate at unity gain | $R_L = 2\text{ k}\Omega$, $C_L = 100\text{ pF}$, See Figure 1 | TLE2027 | 1.7 | 2.8 | | 1.7 | 2.8 | V/ μs |
| | | | TLE2037 | 6 | 7.5 | | 6 | 7.5 | |
| | | $R_L = 2\text{ k}\Omega$, $C_L = 100\text{ pF}$, $T_A = -40^\circ\text{C}$ to 85°C , See Figure 1 | TLE2027 | 1.1 | | | 1.1 | | |
| | | | TLE2037 | 4.7 | | | 4.7 | | |
| V_n | Equivalent input noise voltage (see Figure 2) | $R_S = 20\ \Omega$, $f = 10\text{ Hz}$ | | 3.3 | 8 | | 3.3 | 4.5 | nV/ $\sqrt{\text{Hz}}$ |
| | | $R_S = 20\ \Omega$, $f = 1\text{ kHz}$ | | 2.5 | 4.5 | | 2.5 | 3.8 | |
| $V_{N(PP)}$ | Peak-to-peak equivalent input noise voltage | $f = 0.1\text{ Hz}$ to 10 Hz | | 50 | 250 | | 50 | 130 | nV |
| I_n | Equivalent input noise current | $f = 10\text{ Hz}$ | | 10 | 25 | | 10 | 25 | pA/ $\sqrt{\text{Hz}}$ |
| | | $f = 1\text{ kHz}$ | | 0.8 | 1.8 | | 0.8 | 1.8 | |
| THD | Total harmonic distortion | $V_O = +10\text{ V}$, $A_{VD} = 1$, See Note 5 | TLE2027 | < 0.002% | | | < 0.002% | | |
| | | $V_O = +10\text{ V}$, $A_{VD} = 5$, See Note 5 | TLE2037 | < 0.002% | | | < 0.002% | | |
| B_1 | Unity-gain bandwidth (see Figure 3) | $R_L = 2\text{ k}\Omega$, $C_L = 100\text{ pF}$ | TLE2027 | 9 ⁽⁶⁾ | 13 | | 9 ⁽⁶⁾ | 13 | MHz |
| GBW | Gain bandwidth product | $R_L = 2\text{ k}\Omega$, $C_L = 100\text{ pF}$ | TLE2037 | 35 | 50 | | 35 | 50 | |
| B_{OM} | Maximum output-swing bandwidth | $R_L = 2\text{ k}\Omega$ | TLE2027 | 30 | | | 30 | | kHz |
| | | | TLE2037 | 80 | | | 80 | | |
| ϕ_m | Phase margin at unity gain (see Figure 3) | $R_L = 2\text{ k}\Omega$, $C_L = 100\text{ pF}$ | TLE2027 | 55° | | | 55° | | |
| | | | TLE2037 | 50° | | | 50° | | |

NOTE 5: Measured distortion of the source used in the analysis was 0.002%.

NOTE 6: This parameter is not production tested.

TLE2027, TLE2037, TLE2027A, TLE2037A, TLE2027Y, TLE2037Y EXCALIBUR LOW-NOISE HIGH-SPEED PRECISION OPERATIONAL AMPLIFIERS

SLOS192C – FEBRUARY 1997 – REVISED APRIL 2010

TLE20x7M electrical characteristics at specified free-air temperature, $V_{CC\pm} = \pm 15\text{ V}$ (unless otherwise noted)

| PARAMETER | TEST CONDITIONS | T_A^\dagger | TLE20x7M | | | TLE20x7AM | | | UNIT |
|---|--|---------------|---------------|-----------|-----|---------------|-----------|------------------------------|------|
| | | | MIN | TYP | MAX | MIN | TYP | MAX | |
| V_{IO} Input offset voltage | $V_{IC} = 0, R_S = 50\ \Omega$ | 25°C | 20 | 100 | | 10 | 25 | μV | |
| | | Full range | | | 200 | | 105 | | |
| α_{VIO} Temperature coefficient of input offset voltage | | Full range | 0.4 | 1* | | 0.2 | 1* | $\mu\text{V}/^\circ\text{C}$ | |
| Input offset voltage long-term drift (see Note 4) | | 25°C | 0.006 | 1* | | 0.006 | 1* | $\mu\text{V}/\text{mo}$ | |
| I_{IO} Input offset current | | 25°C | 6 | 90 | | 6 | 90 | nA | |
| | | Full range | | | 150 | | 150 | | |
| I_{IB} Input bias current | 25°C | 15 | 90 | | 15 | 90 | nA | | |
| | Full range | | | 150 | | 150 | | | |
| V_{ICR} Common-mode input voltage range | $R_S = 50\ \Omega$ | 25°C | -11 to 11 | -13 to 13 | | -11 to 11 | -13 to 13 | V | |
| | | Full range | -10.3 to 10.3 | | | -10.4 to 10.4 | | | |
| V_{OM+} Maximum positive peak output voltage swing | $R_L = 600\ \Omega$ | 25°C | 10.5 | 12.9 | | 10.5 | 12.9 | V | |
| | | Full range | 10 | | | 10 | | | |
| | $R_L = 2\ \text{k}\Omega$ | 25°C | 12 | 13.2 | | 12 | 13.2 | | |
| | | Full range | 11 | | | 11 | | | |
| V_{OM-} Maximum negative peak output voltage swing | $R_L = 600\ \Omega$ | 25°C | -10.5 | -13 | | -10.5 | -13 | V | |
| | | Full range | -10 | | | -10 | | | |
| | $R_L = 2\ \text{k}\Omega$ | 25°C | -12 | -13.5 | | -12 | -13.5 | | |
| | | Full range | -11 | | | -11 | | | |
| A_{VD} Large-signal differential voltage amplification | $V_O = \pm 11\ \text{V}, R_L = 2\ \text{k}\Omega$ | 25°C | 5 | 45 | | 10 | 45 | V/ μV | |
| | $V_O = \pm 10\ \text{V}, R_L = 2\ \text{k}\Omega$ | Full range | 2.5 | | | 3.5 | | | |
| | $V_O = \pm 10\ \text{V}, R_L = 1\ \text{k}\Omega$ | 25°C | 3.5 | 38 | | 8 | 38 | | |
| | | Full range | 1.8 | | | 2.2 | | | |
| | $V_O = \pm 10\ \text{V}, R_L = 600\ \Omega$ | 25°C | 2 | 19 | | 5 | 19 | | |
| C_i Input capacitance | | 25°C | | 8 | | 8 | pF | | |
| z_o Open-loop output impedance | $I_O = 0$ | 25°C | | 50 | | 50 | Ω | | |
| CMRR Common-mode rejection ratio | $V_{IC} = V_{ICRmin}, R_S = 50\ \Omega$ | 25°C | 100 | 131 | | 117 | 131 | dB | |
| | | Full range | 96 | | | 113 | | | |
| k_{SVR} Supply-voltage rejection ratio ($\Delta V_{CC\pm} / \Delta V_{IO}$) | $V_{CC\pm} = \pm 4\ \text{V to } \pm 18\ \text{V}, R_S = 50\ \Omega$ | 25°C | 94 | 144 | | 110 | 144 | dB | |
| | $V_{CC\pm} = \pm 4\ \text{V to } \pm 18\ \text{V}, R_S = 50\ \Omega$ | Full range | 90 | | | 105 | | | |
| I_{CC} Supply current | $V_O = 0, \text{ No load}$ | 25°C | 3.8 | 5.3 | | 3.8 | 5.3 | mA | |
| | | Full range | | | 5.6 | | 5.6 | | |

* On products compliant to MIL-PRF-38535, this parameter is not production tested.

† Full range is -55°C to 125°C .

NOTE 4: Typical values are based on the input offset voltage shift observed through 168 hours of operating life test at $T_A = 150^\circ\text{C}$ extrapolated to $T_A = 25^\circ\text{C}$ using the Arrhenius equation and assuming an activation energy of 0.96 eV.

TLE2027, TLE2037, TLE2027A, TLE2037A, TLE2027Y, TLE2037Y
EXCALIBUR LOW-NOISE HIGH-SPEED
PRECISION OPERATIONAL AMPLIFIERS

SLOS192C – FEBRUARY 1997 – REVISED APRIL 2010

TLE20x7M operating characteristics at specified free-air temperature, $V_{CC} \pm = \pm 15\text{ V}$, $T_A = 25^\circ\text{C}$ (unless otherwise specified)

| PARAMETER | TEST CONDITIONS | | TLE20x7M | | | TLE20x7AM | | | UNIT |
|-------------|---|---|--|------------|------|-----------|------------|------|------------------------|
| | | | MIN | TYP | MAX | MIN | TYP | MAX | |
| SR | Slew rate at unity gain | $R_L = 2\text{ k}\Omega$, $C_L = 100\text{ pF}$, See Figure 1 | TLE2027 | 1.7 | 2.8 | | 1.7 | 2.8 | V/ μs |
| | | | TLE2037 | 6* | 7.5 | | 6* | 7.5 | |
| | $R_L = 2\text{ k}\Omega$, $C_L = 100\text{ pF}$, $T_A = -55^\circ\text{C}$ to 125°C , See Figure 1 | TLE2027 | 1 | | | 1 | | | |
| | | TLE2037 | 4.4* | | | 4.4* | | | |
| V_n | Equivalent input noise voltage (see Figure 2) | $R_S = 20\ \Omega$, $f = 10\text{ Hz}$ | | 3.3 | 8* | | 3.3 | 8* | nV/ $\sqrt{\text{Hz}}$ |
| | | | $R_S = 20\ \Omega$, $f = 1\text{ kHz}$ | | 2.5 | 4* | | 2.5 | |
| $V_{N(PP)}$ | Peak-to-peak equivalent input noise voltage | $f = 0.1\text{ Hz}$ to 10 Hz | | 225 | 375* | | 225 | 375* | nV |
| I_n | Equivalent input noise current | $f = 10\text{ Hz}$ | | 25 | | | 25 | | pA/ $\sqrt{\text{Hz}}$ |
| | | $f = 1\text{ kHz}$ | | 2.5 | | | 2.5 | | |
| THD | Total harmonic distortion | $V_O = +10\text{ V}$, $A_{VD} = 1$, See Note 5 | TLE2027 | < 0.002% | | | < 0.002% | | |
| | | $V_O = +10\text{ V}$, $A_{VD} = 5$, See Note 5 | TLE2037 | < 0.002% | | | < 0.002% | | |
| B_1 | Unity-gain bandwidth (see Figure 3) | $R_L = 2\text{ k}\Omega$, $C_L = 100\text{ pF}$ | TLE2027 | 7* | 13 | | 9* | 13 | MHz |
| | | | TLE2037 | 35 | 50 | | 35 | 50 | |
| B_{OM} | Maximum output-swing bandwidth | $R_L = 2\text{ k}\Omega$ | TLE2027 | 30 | | | 30 | | kHz |
| | | | TLE2037 | 80 | | | 80 | | |
| ϕ_m | Phase margin at unity gain (see Figure 3) | $R_L = 2\text{ k}\Omega$, $C_L = 100\text{ pF}$ | TLE2027 | 55° | | | 55° | | |
| | | | TLE2037 | 50° | | | 50° | | |

* On products compliant to MIL-PRF-38535, this parameter is not production tested.

NOTE 5: Measured distortion of the source used in the analysis was 0.002%.

TLE2027, TLE2037, TLE2027A, TLE2037A, TLE2027Y, TLE2037Y
EXCALIBUR LOW-NOISE HIGH-SPEED
PRECISION OPERATIONAL AMPLIFIERS

SLOS192C – FEBRUARY 1997 – REVISED APRIL 2010

TLE20x7Y electrical characteristics, $V_{CC\pm} = \pm 15\text{ V}$, $T_A = 25^\circ\text{C}$ (unless otherwise noted)

| PARAMETER | TEST CONDITIONS | TLE20x7Y | | | UNIT |
|---|--|-----------|-----|-----|-------------------------|
| | | MIN | TYP | MAX | |
| V_{IO} Input offset voltage | $V_{IC} = 0, R_S = 50\ \Omega$ | 20 | | | μV |
| Input offset voltage long-term drift (see Note 4) | | 0.006 | | | $\mu\text{V}/\text{mo}$ |
| I_{IO} Input offset current | | 6 | | | nA |
| I_{IB} Input bias current | | 15 | | | nA |
| V_{ICR} Common-mode input voltage range | $R_S = 50\ \Omega$ | -13 to 13 | | | V |
| V_{OM+} Maximum positive peak output voltage swing | $R_L = 600\ \Omega$ | 12.9 | | | V |
| | $R_L = 2\ \text{k}\Omega$ | 13.2 | | | |
| V_{OM-} Maximum negative peak output voltage swing | $R_L = 600\ \Omega$ | -13 | | | V |
| | $R_L = 2\ \text{k}\Omega$ | -13.5 | | | |
| A_{VD} Large-signal differential voltage amplification | $V_O = \pm 11\ \text{V}, R_L = 2\ \text{k}\Omega$ | 45 | | | V/ μV |
| | $V_O = \pm 10\ \text{V}, R_L = 1\ \text{k}\Omega$ | 38 | | | |
| | $V_O = \pm 10\ \text{V}, R_L = 600\ \Omega$ | 19 | | | |
| C_i Input capacitance | | 8 | | | pF |
| z_o Open-loop output impedance | $I_O = 0$ | 50 | | | Ω |
| CMRR Common-mode rejection ratio | $V_{IC} = V_{ICR\text{min}}, R_S = 50\ \Omega$ | 131 | | | dB |
| k_{SVR} Supply-voltage rejection ratio ($\Delta V_{CC\pm} / \Delta V_{IO}$) | $V_{CC\pm} = \pm 4\ \text{V to } \pm 18\ \text{V}, R_S = 50\ \Omega$ | 144 | | | dB |
| I_{CC} Supply current | $V_O = 0, \text{ No load}$ | 3.8 | | | mA |

NOTE 4: Typical values are based on the input offset voltage shift observed through 168 hours of operating life test at $T_A = 150^\circ\text{C}$ extrapolated to $T_A = 25^\circ\text{C}$ using the Arrhenius equation and assuming an activation energy of 0.96 eV.

TLE2027, TLE2037, TLE2027A, TLE2037A, TLE2027Y, TLE2037Y
EXCALIBUR LOW-NOISE HIGH-SPEED
PRECISION OPERATIONAL AMPLIFIERS

SLOS192C – FEBRUARY 1997 – REVISED APRIL 2010

TLE20x7Y operating characteristics at specified free-air temperature, $V_{CC\pm} = \pm 15\text{ V}$

| PARAMETER | | TEST CONDITIONS | | TLE20x7Y | | | UNIT |
|-------------|---|--|---------|----------|------------------------|------------------|------|
| | | | | MIN | TYP | MAX | |
| SR | Slew rate at unity gain | $R_L = 2\text{ k}\Omega$, $C_L = 100\text{ pF}$, See Figure 1 | TLE2027 | 2.8 | | V/ μs | |
| | | | TLE2037 | 7.5 | | | |
| V_n | Equivalent input noise voltage (see Figure 2) | $R_S = 20\ \Omega$, $f = 10\text{ Hz}$ $R_S = 20\ \Omega$, $f = 1\text{ kHz}$ | 3.3 | | nV/ $\sqrt{\text{Hz}}$ | | |
| | | | 2.5 | | | | |
| $V_{N(PP)}$ | Peak-to-peak equivalent input noise voltage | $f = 0.1\text{ Hz to }10\text{ Hz}$ | 50 | | nV | | |
| I_n | Equivalent input noise current | $f = 10\text{ Hz}$ | 10 | | pA/ $\sqrt{\text{Hz}}$ | | |
| | | $f = 1\text{ kHz}$ | 0.8 | | | | |
| THD | Total harmonic distortion | $V_O = +10\text{ V}$, $A_{VD} = 1$, See Note 5 | TLE2027 | <0.002% | | | |
| | | $V_O = +10\text{ V}$, $A_{VD} = 5$, See Note 5 | TLE2037 | <0.002% | | | |
| B_1 | Unity-gain bandwidth (see Figure 3) | $R_L = 2\text{ k}\Omega$, $C_L = 100\text{ pF}$ | TLE2027 | 13 | | MHz | |
| | | | TLE2037 | 50 | | | |
| B_{OM} | Maximum output-swing bandwidth | $R_L = 2\text{ k}\Omega$ | TLE2027 | 30 | | kHz | |
| | | | TLE2037 | 80 | | | |
| ϕ_m | Phase margin at unity gain (see Figure 3) | $R_L = 2\text{ k}\Omega$, $C_L = 100\text{ pF}$ | TLE2027 | 55° | | | |
| | | | TLE2037 | 50° | | | |

NOTE 5: Measured distortion of the source used in the analysis was 0.002%.

TLE2027, TLE2037, TLE2027A, TLE2037A, TLE2027Y, TLE2037Y
EXCALIBUR LOW-NOISE HIGH-SPEED
PRECISION OPERATIONAL AMPLIFIERS

SLOS192C – FEBRUARY 1997 – REVISED APRIL 2010

PARAMETER MEASUREMENT INFORMATION

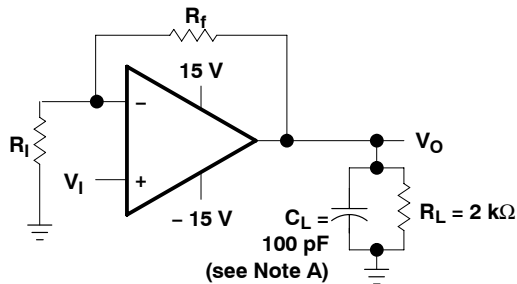

NOTE A: C_L includes fixture capacitance.

Figure 1. Slew-Rate Test Circuit

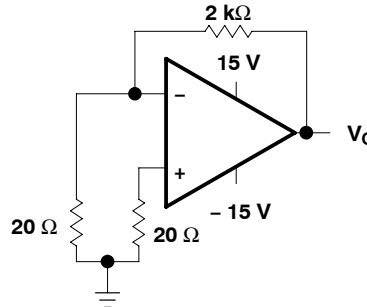
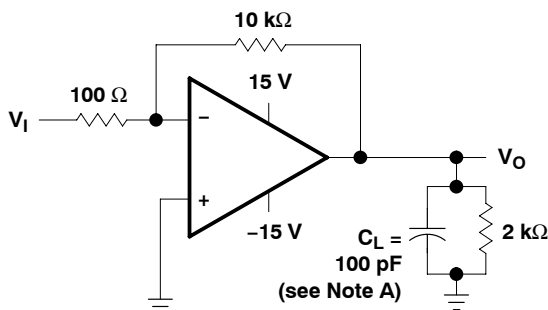
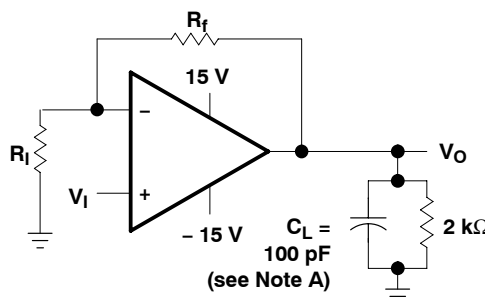

Figure 2. Noise-Voltage Test Circuit



NOTE A: C_L includes fixture capacitance.

Figure 3. Unity-Gain Bandwidth and Phase-Margin Test Circuit (TLE2027 Only)



NOTES: A. C_L includes fixture capacitance.
 B. For the TLE2037 and TLE2037A, A_{VD} must be ≥ 5 .

Figure 4. Small-Signal Pulse-Response Test Circuit

typical values

Typical values presented in this data sheet represent the median (50% point) of device parametric performance.

initial estimates of parameter distributions

In the ongoing program of improving data sheets and supplying more information to our customers, Texas Instruments has added an estimate of not only the typical values but also the spread around these values. These are in the form of distribution bars that show the 95% (upper) points and the 5% (lower) points from the characterization of the initial wafer lots of this new device type (see Figure 5). The distribution bars are shown at the points where data was actually collected. The 95% and 5% points are used instead of ± 3 sigma since some of the distributions are not true Gaussian distributions.

The number of units tested and the number of different wafer lots used are on all of the graphs where distribution bars are shown. As noted in Figure 5, there were a total of 835 units from two wafer lots. In this case, there is a good estimate for the within-lot variability and a possibly poor estimate of the lot-to-lot variability. This is always the case on newly released products since there can only be data available from a few wafer lots.

The distribution bars are not intended to replace the minimum and maximum limits in the electrical tables. Each distribution bar represents 90% of the total units tested at a specific temperature. While 10% of the units tested fell outside any given distribution bar, this should not be interpreted to mean that the same individual devices fell outside every distribution bar.

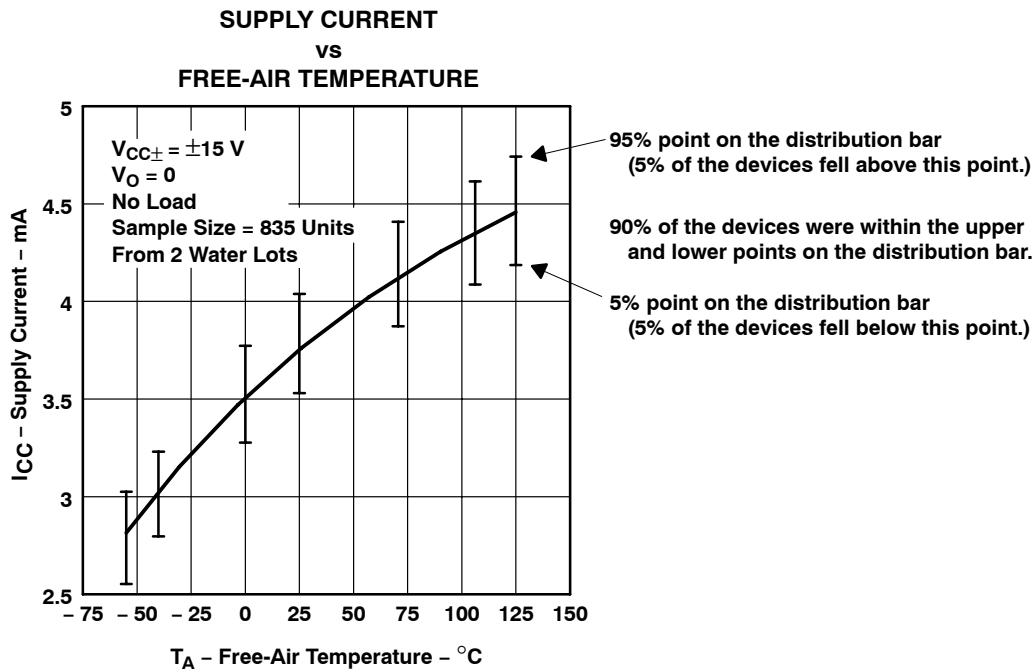

TLE2027, TLE2037, TLE2027A, TLE2037A, TLE2027Y, TLE2037Y
EXCALIBUR LOW-NOISE HIGH-SPEED
PRECISION OPERATIONAL AMPLIFIERS

SLOS192C – FEBRUARY 1997 – REVISED APRIL 2010

TYPICAL CHARACTERISTICS

Table of Graphs

| | | FIGURE | |
|-----------------|---|-------------------------------|---------|
| V_{IO} | Input offset voltage | Distribution | 6, 7 |
| ΔV_{IO} | Input offset voltage change | vs Time after power on | 8, 9 |
| I_{IO} | Input offset current | vs Free-air temperature | 10 |
| I_{IB} | Input bias current | vs Free-air temperature | 11 |
| | | vs Common-mode input voltage | 12 |
| I_I | Input current | vs Differential input voltage | 13 |
| $V_{O(PP)}$ | Maximum peak-to-peak output voltage | vs Frequency | 14, 15 |
| V_{OM} | Maximum (positive/negative) peak output voltage | vs Load resistance | 16, 17 |
| | | vs Free-air temperature | 18, 19 |
| A_{VD} | Large-signal differential voltage amplification | vs Supply voltage | 20 |
| | | vs Load resistance | 21 |
| | | vs Frequency | 22 – 25 |
| | | vs Free-air temperature | 26 |
| z_o | Output impedance | vs Frequency | 27 |
| CMRR | Common-mode rejection ratio | vs Frequency | 28 |
| k_{SVR} | Supply-voltage rejection ratio | vs Frequency | 29 |
| I_{OS} | Short-circuit output current | vs Supply voltage | 30, 31 |
| | | vs Elapsed time | 32, 33 |
| | | vs Free-air temperature | 34, 35 |
| I_{CC} | Supply current | vs Supply voltage | 36 |
| | | vs Free-air temperature | 37 |
| | Voltage-follower pulse response | Small signal | 38, 40 |
| | | Large signal | 39, 41 |
| V_n | Equivalent input noise voltage | vs Frequency | 42 |
| | Noise voltage (referred to input) | Over 10-second interval | 43 |
| B_1 | Unity-gain bandwidth | vs Supply voltage | 44 |
| | | vs Load capacitance | 45 |
| | Gain bandwidth product | vs Supply voltage | 46 |
| | | vs Load capacitance | 47 |
| SR | Slew rate | vs Free-air temperature | 48, 49 |
| ϕ_m | Phase margin | vs Supply voltage | 50, 51 |
| | | vs Load capacitance | 52, 53 |
| | | vs Free-air temperature | 54, 55 |
| | Phase shift | vs Frequency | 22 – 25 |

TYPICAL CHARACTERISTICS

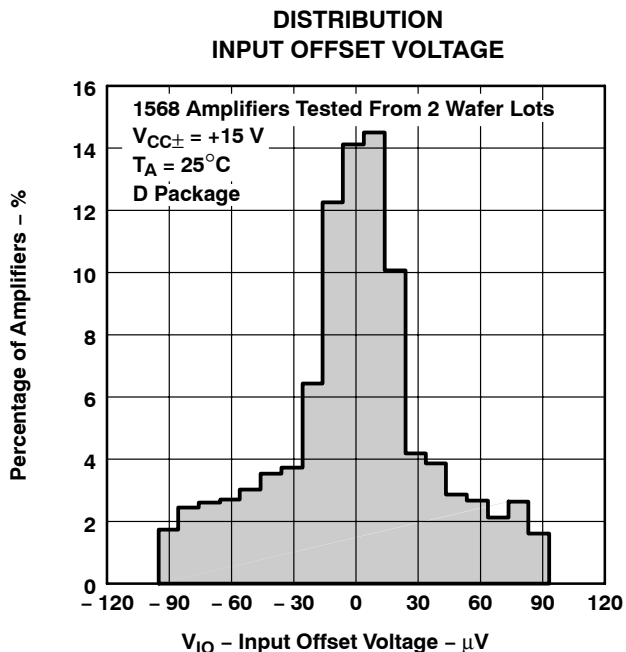

Figure 6

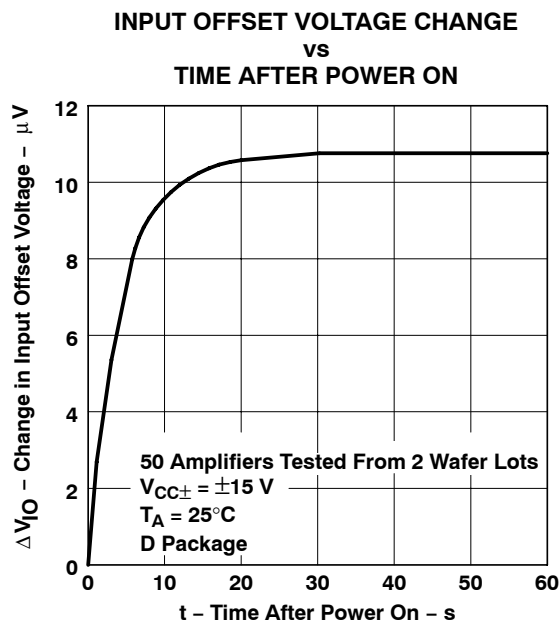

Figure 7

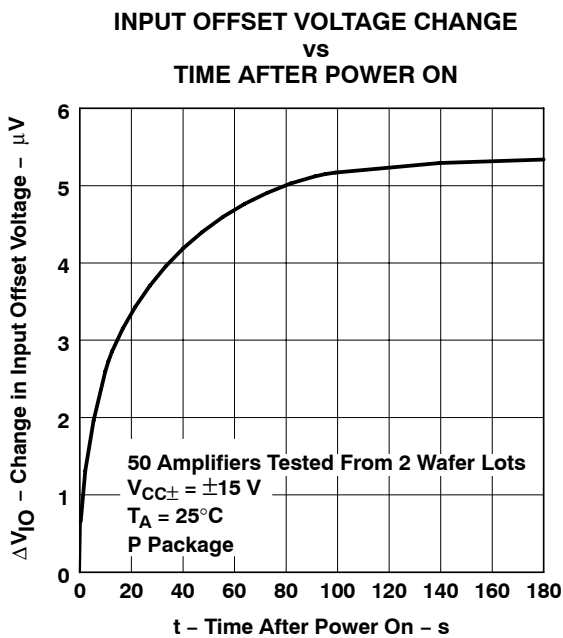

Figure 8

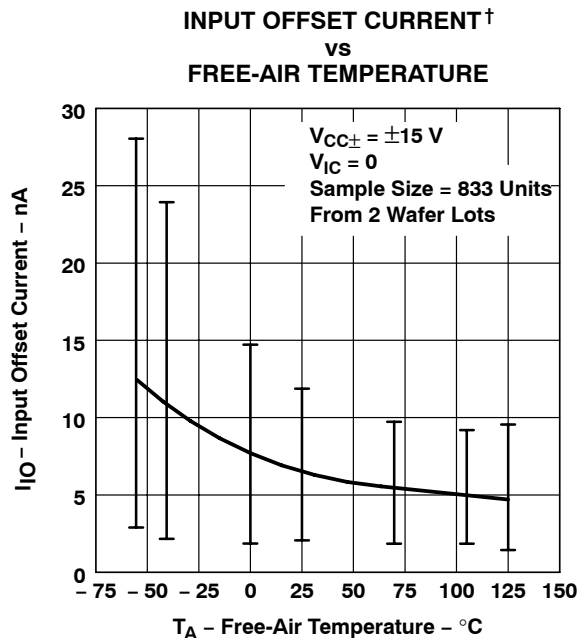

Figure 9

† Data at high and low temperatures are applicable only within the rated operating free-air temperature ranges of the various devices.

TLE2027, TLE2037, TLE2027A, TLE2037A, TLE2027Y, TLE2037Y
EXCALIBUR LOW-NOISE HIGH-SPEED
PRECISION OPERATIONAL AMPLIFIERS

SLOS192C – FEBRUARY 1997 – REVISED APRIL 2010

TYPICAL CHARACTERISTICS

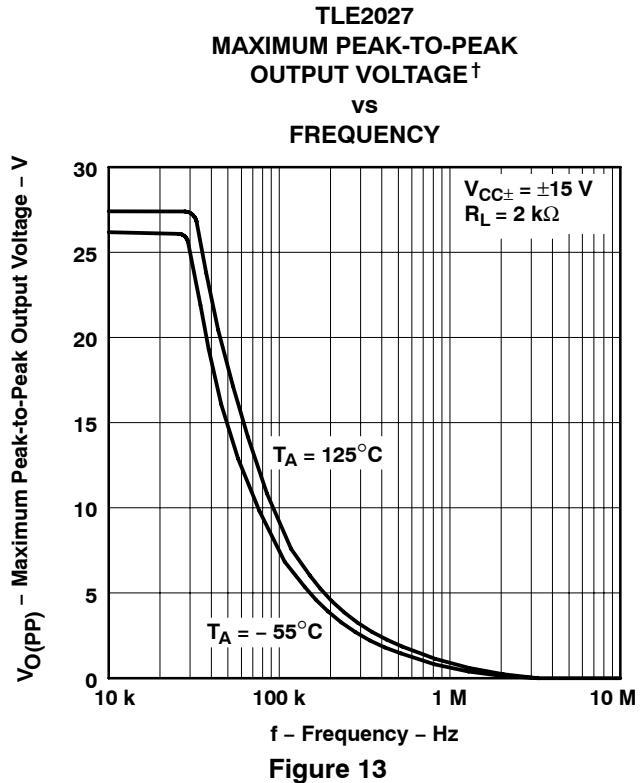
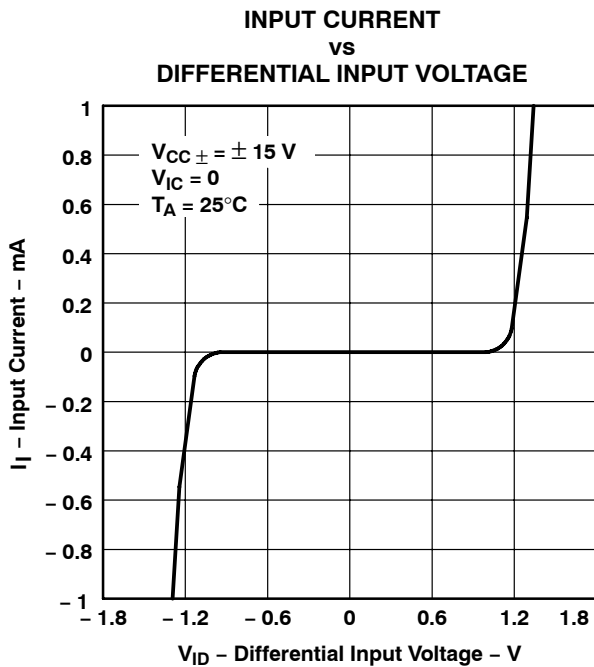
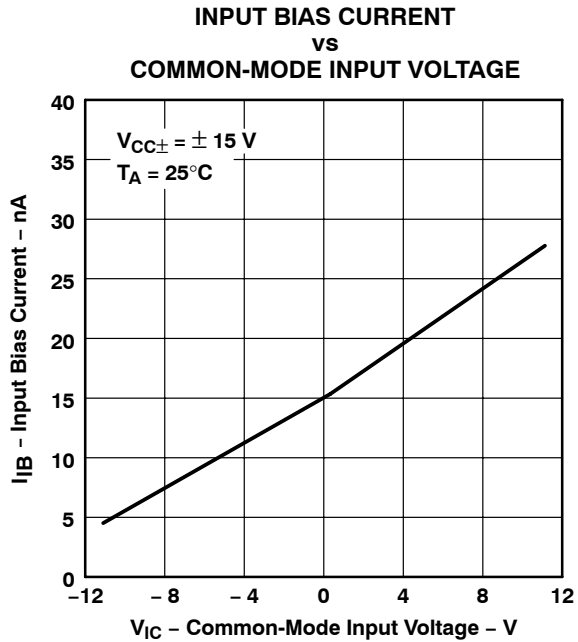
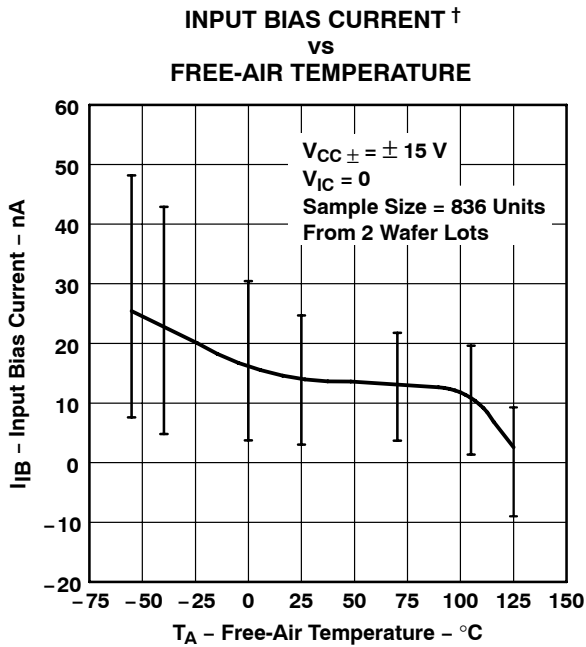

† Data at high and low temperatures are applicable only within the rated operating free-air temperature ranges of the various devices.

TYPICAL CHARACTERISTICS

**TLE2037
 MAXIMUM PEAK-TO-PEAK
 OUTPUT VOLTAGE[†]
 vs
 FREQUENCY**

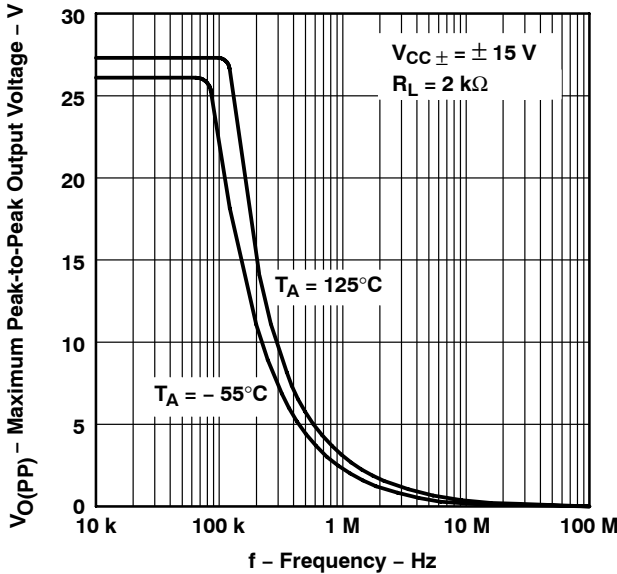

Figure 14

**MAXIMUM POSITIVE PEAK
 OUTPUT VOLTAGE
 vs
 LOAD RESISTANCE**

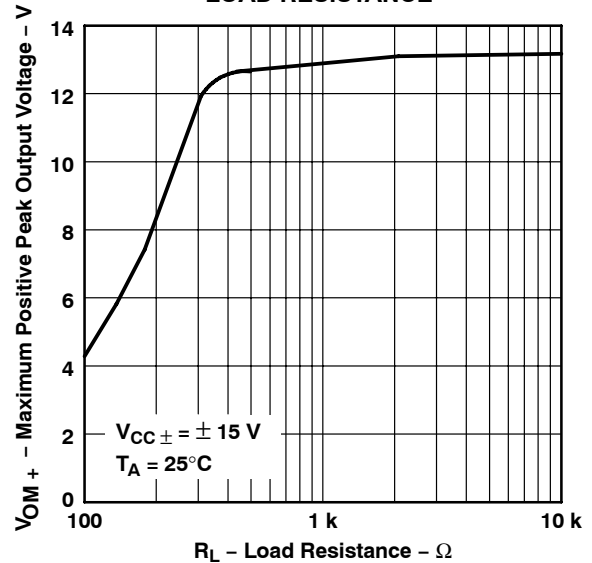

Figure 15

**MAXIMUM NEGATIVE PEAK
 OUTPUT VOLTAGE
 vs
 LOAD RESISTANCE**

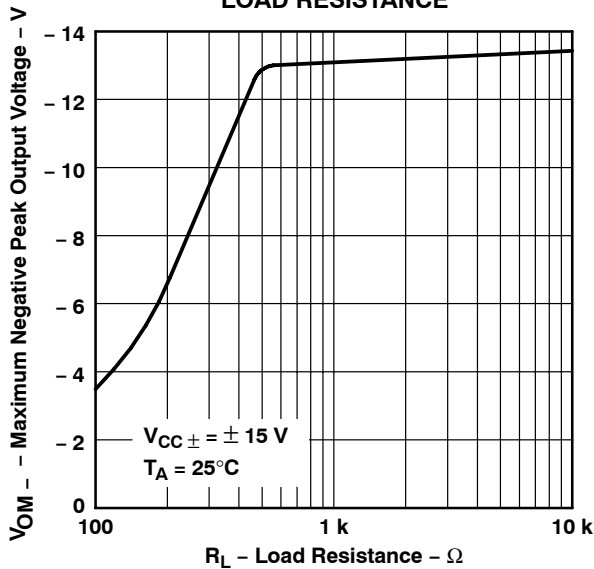

Figure 16

**MAXIMUM POSITIVE PEAK
 OUTPUT VOLTAGE[†]
 vs
 FREE-AIR TEMPERATURE**

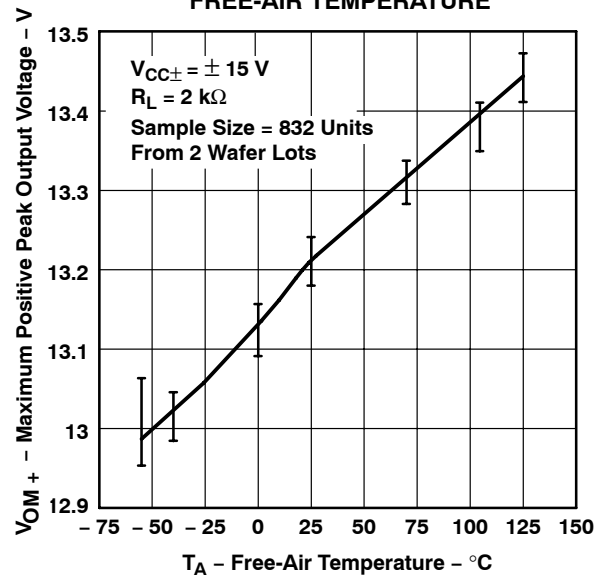

Figure 17

[†] Data at high and low temperatures are applicable only within the rated operating free-air temperature ranges of the various devices.

TLE2027, TLE2037, TLE2027A, TLE2037A, TLE2027Y, TLE2037Y
EXCALIBUR LOW-NOISE HIGH-SPEED
PRECISION OPERATIONAL AMPLIFIERS

SLOS192C – FEBRUARY 1997 – REVISED APRIL 2010

TYPICAL CHARACTERISTICS

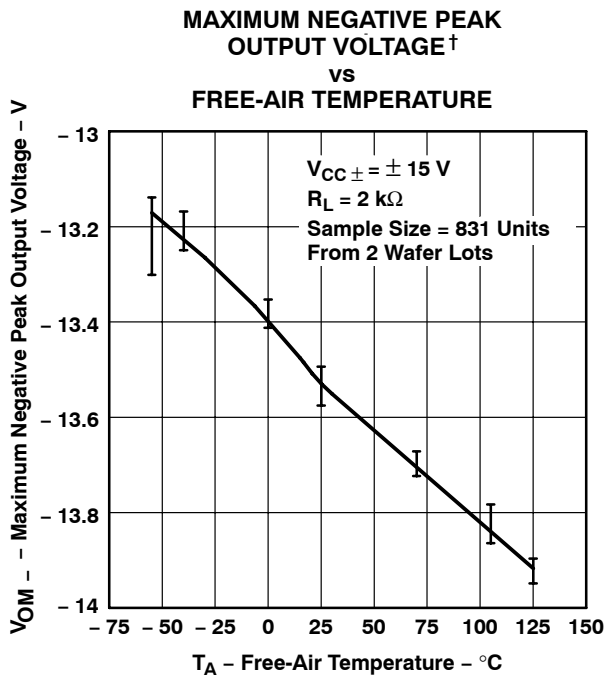

Figure 18

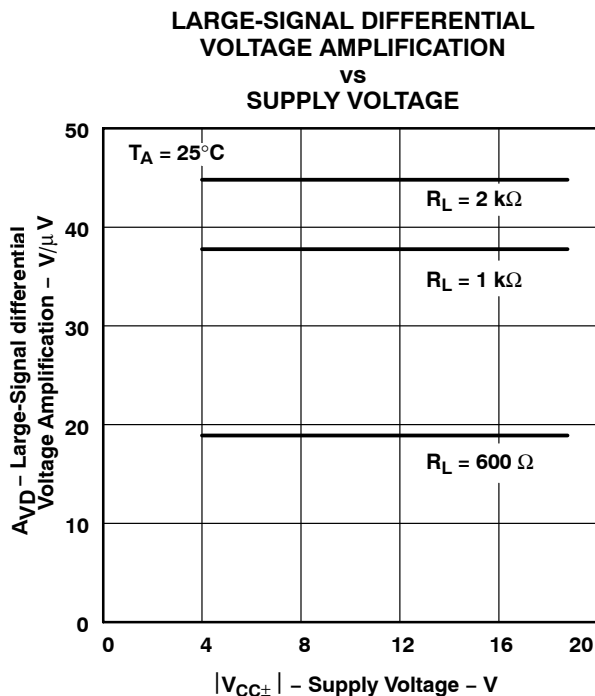

Figure 19

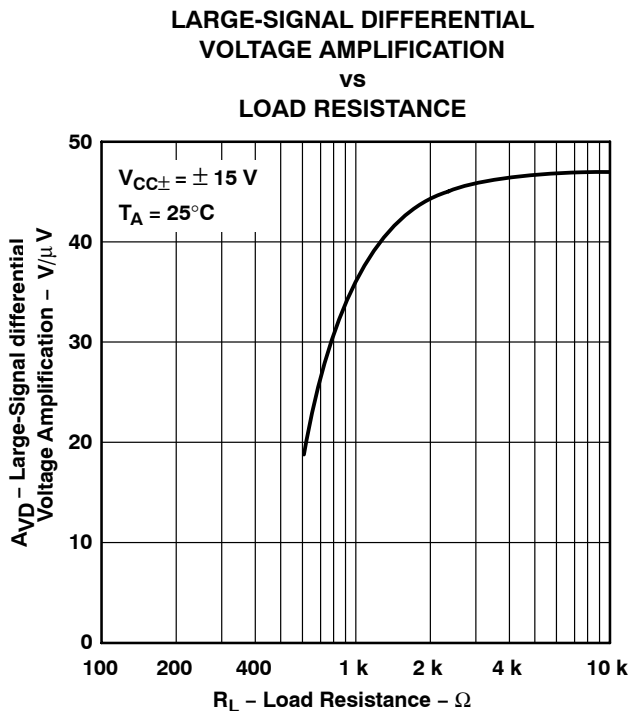

Figure 20

[†] Data at high and low temperatures are applicable only within the rated operating free-air temperature ranges of the various devices.

TYPICAL CHARACTERISTICS

TLE2027
 LARGE-SIGNAL DIFFERENTIAL VOLTAGE
 AMPLIFICATION AND PHASE SHIFT
 vs
 FREQUENCY

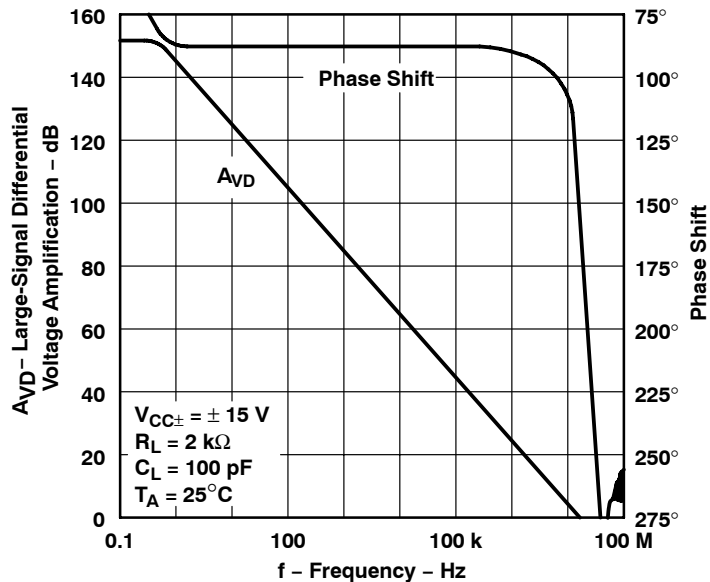

Figure 21

TLE2037
 LARGE-SIGNAL DIFFERENTIAL VOLTAGE
 AMPLIFICATION AND PHASE SHIFT
 vs
 FREQUENCY

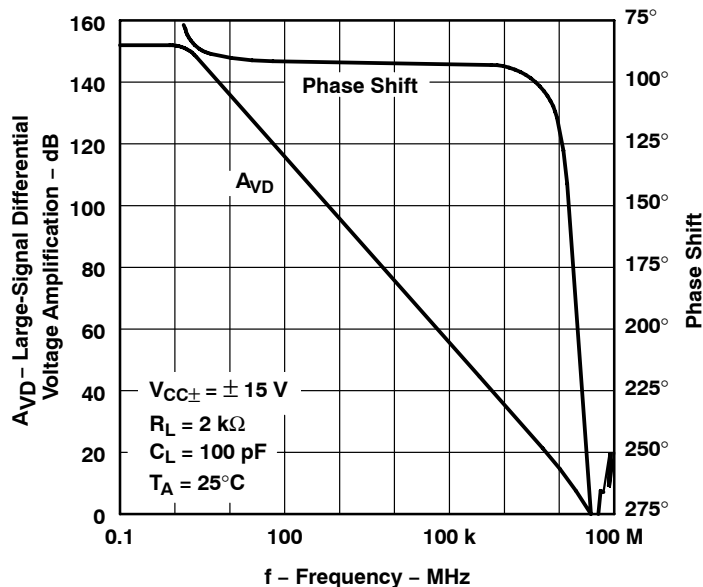

Figure 22

TLE2027, TLE2037, TLE2027A, TLE2037A, TLE2027Y, TLE2037Y
EXCALIBUR LOW-NOISE HIGH-SPEED
PRECISION OPERATIONAL AMPLIFIERS

SLOS192C – FEBRUARY 1997 – REVISED APRIL 2010

TYPICAL CHARACTERISTICS

TLE2027
LARGE-SIGNAL DIFFERENTIAL VOLTAGE
AMPLIFICATION AND PHASE SHIFT
vs
FREQUENCY

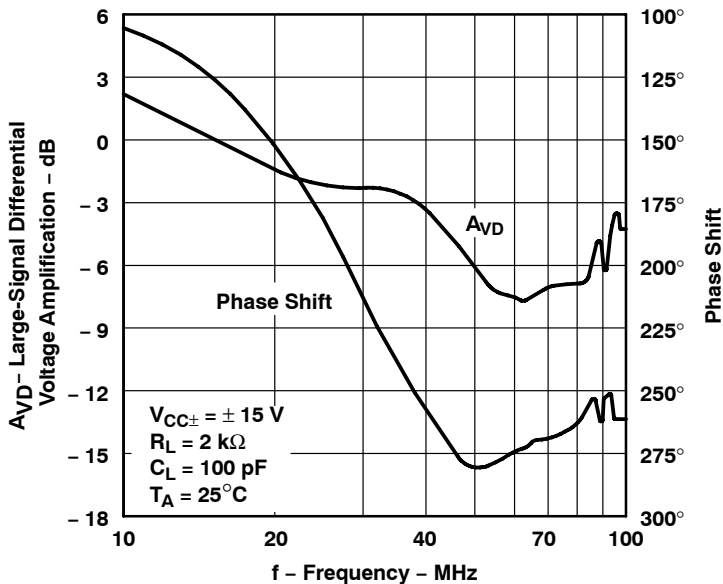

Figure 23

TLE2037
LARGE-SIGNAL DIFFERENTIAL VOLTAGE
AMPLIFICATION AND PHASE SHIFT
vs
FREQUENCY

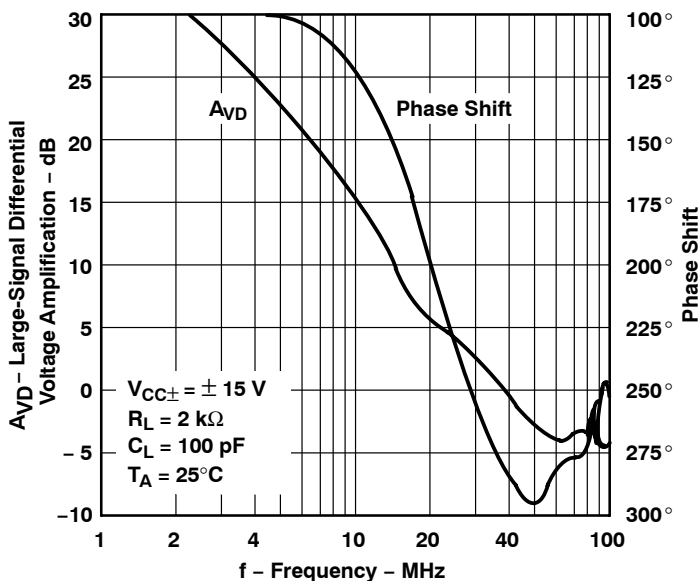

Figure 24

TYPICAL CHARACTERISTICS

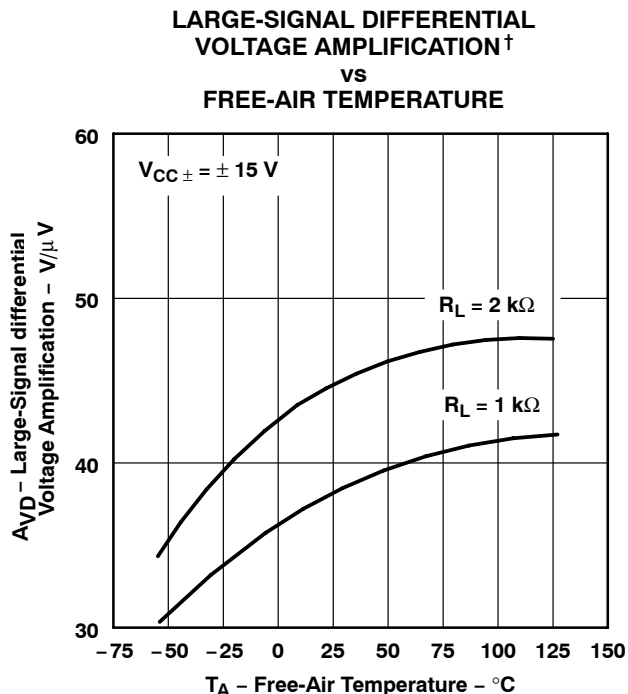
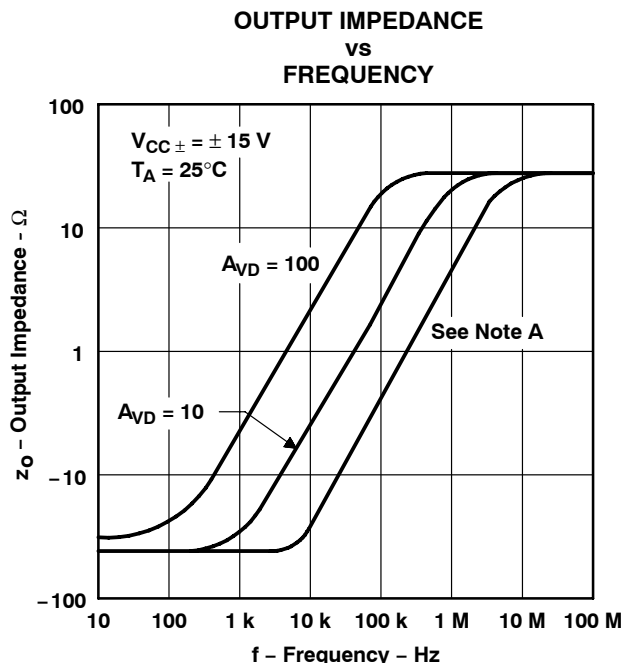

Figure 25



NOTE A: For this curve, the TLE2027 is $A_{VD} = 1$ and the TLE2037 is $A_{VD} = 5$.

Figure 26

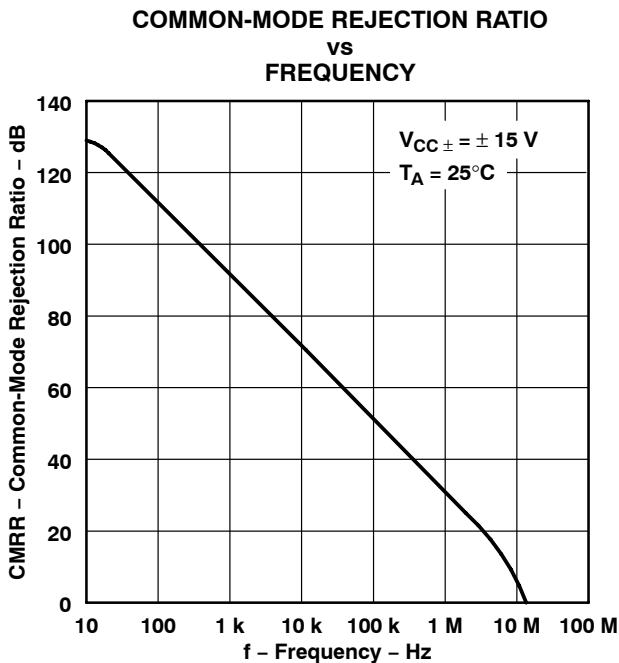

Figure 27

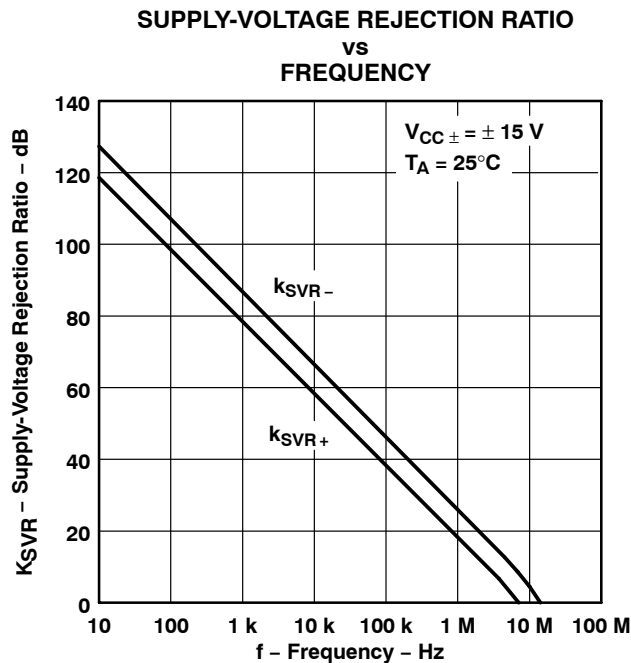

Figure 28

† Data at high and low temperatures are applicable only within the rated operating free-air temperature ranges of the various devices.

TLE2027, TLE2037, TLE2027A, TLE2037A, TLE2027Y, TLE2037Y
EXCALIBUR LOW-NOISE HIGH-SPEED
PRECISION OPERATIONAL AMPLIFIERS

SLOS192C – FEBRUARY 1997 – REVISED APRIL 2010

TYPICAL CHARACTERISTICS

SHORT-CIRCUIT OUTPUT CURRENT
vs
SUPPLY VOLTAGE

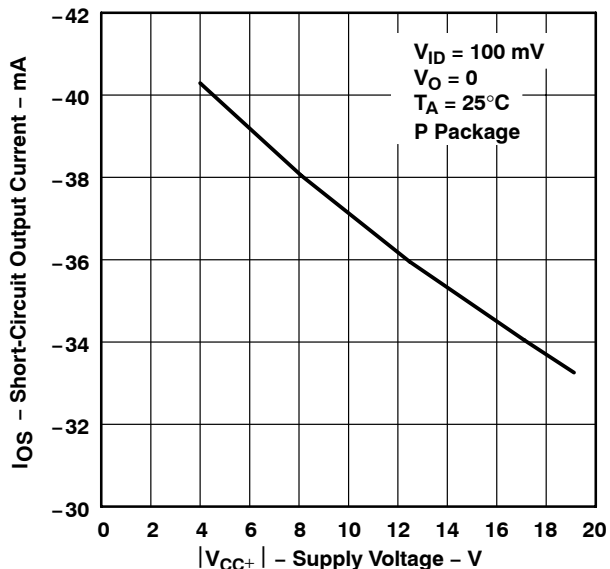

Figure 29

SHORT-CIRCUIT OUTPUT CURRENT
vs
SUPPLY VOLTAGE

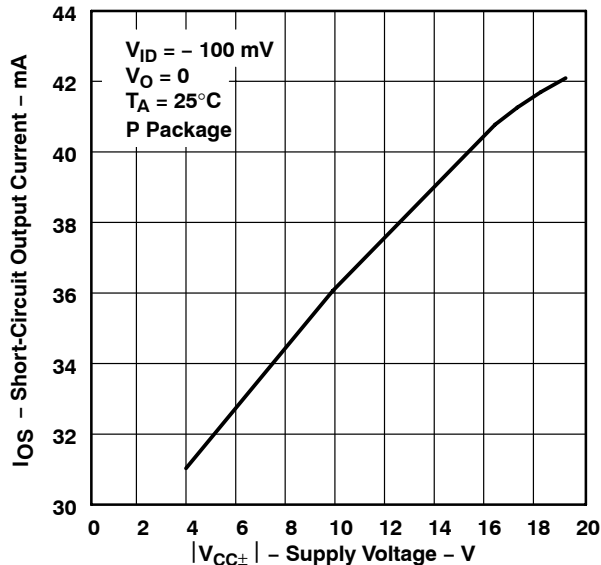

Figure 30

SHORT-CIRCUIT OUTPUT CURRENT
vs
ELAPSED TIME

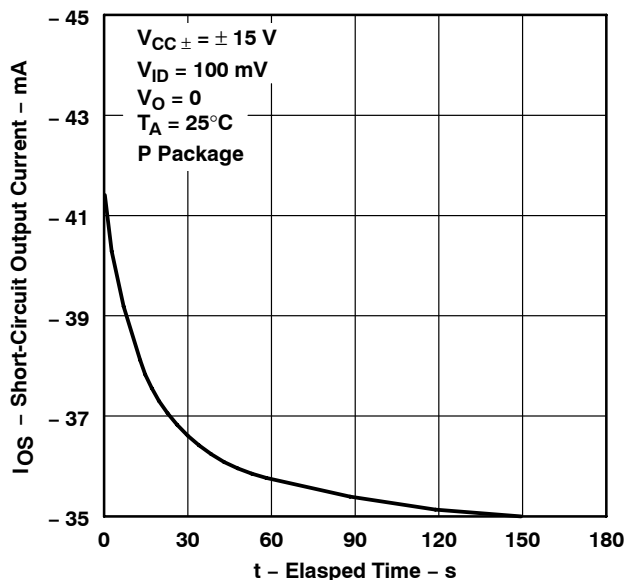

Figure 31

SHORT-CIRCUIT OUTPUT CURRENT
vs
ELAPSED TIME

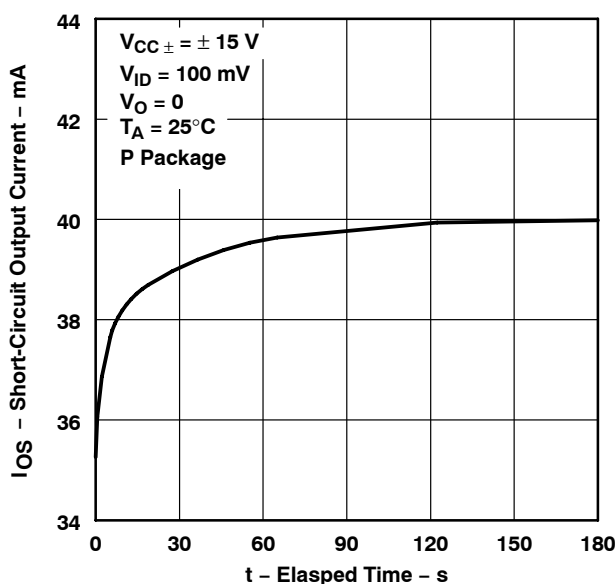

Figure 32

TYPICAL CHARACTERISTICS

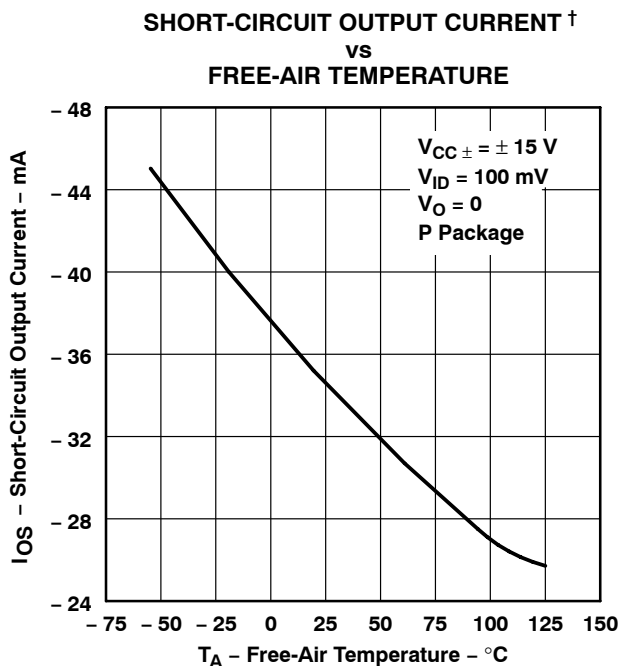

Figure 33

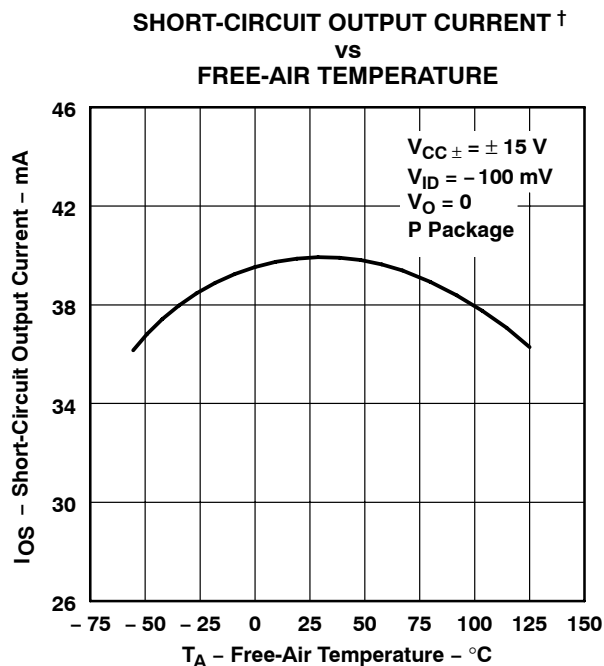

Figure 34

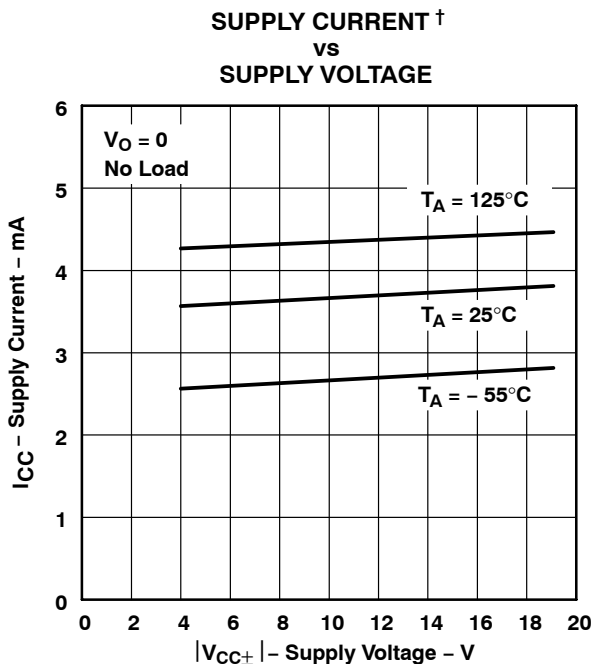

Figure 35

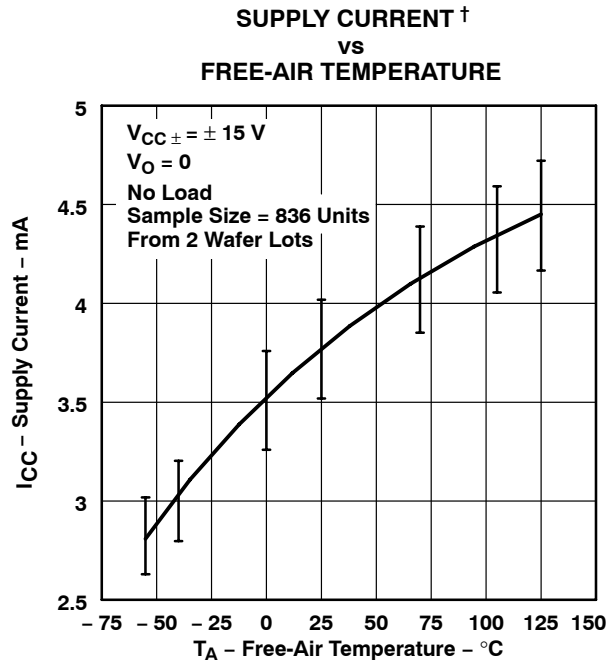

Figure 36

† Data at high and low temperatures are applicable only within the rated operating free-air temperature ranges of the various devices.

TLE2027, TLE2037, TLE2027A, TLE2037A, TLE2027Y, TLE2037Y
EXCALIBUR LOW-NOISE HIGH-SPEED
PRECISION OPERATIONAL AMPLIFIERS

SLOS192C – FEBRUARY 1997 – REVISED APRIL 2010

TYPICAL CHARACTERISTICS

TLE2027
VOLTAGE-FOLLOWER
SMALL-SIGNAL
PULSE RESPONSE

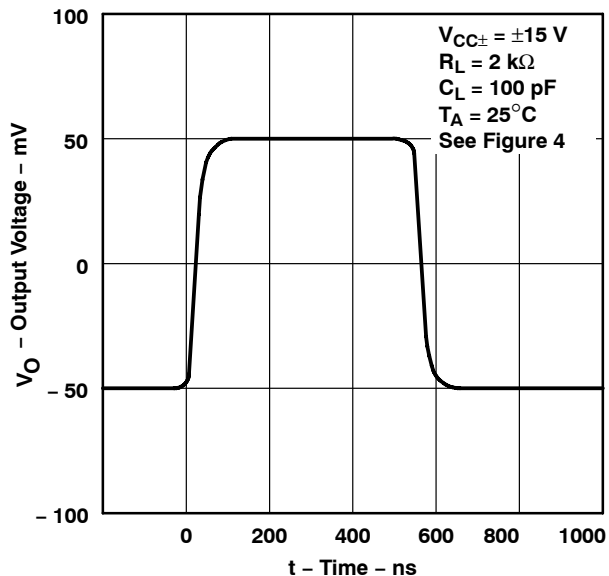

Figure 37

TLE2027
VOLTAGE-FOLLOWER
LARGE-SIGNAL
PULSE RESPONSE

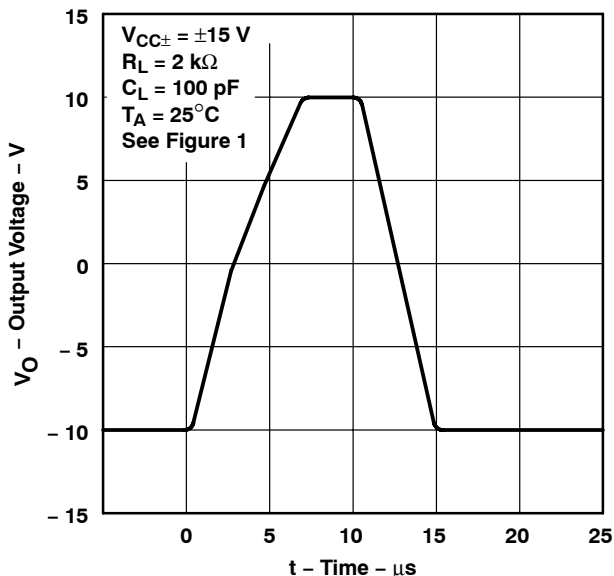

Figure 38

TLE2037
VOLTAGE-FOLLOWER
SMALL-SIGNAL
PULSE RESPONSE

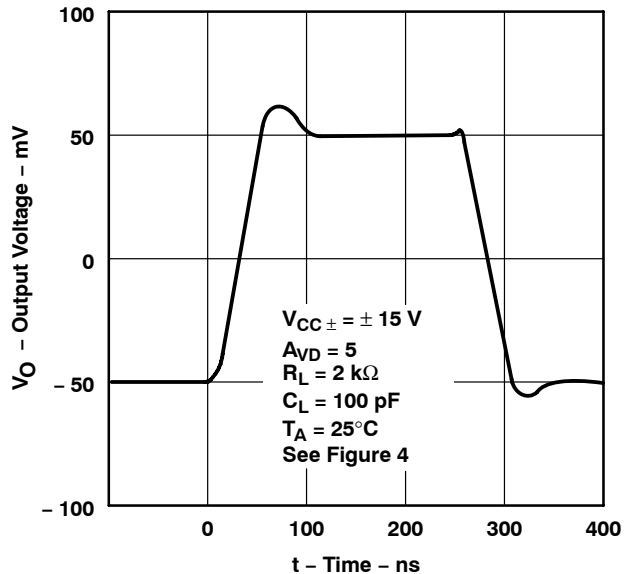

Figure 39

TLE2037
VOLTAGE-FOLLOWER
LARGE-SIGNAL
PULSE RESPONSE

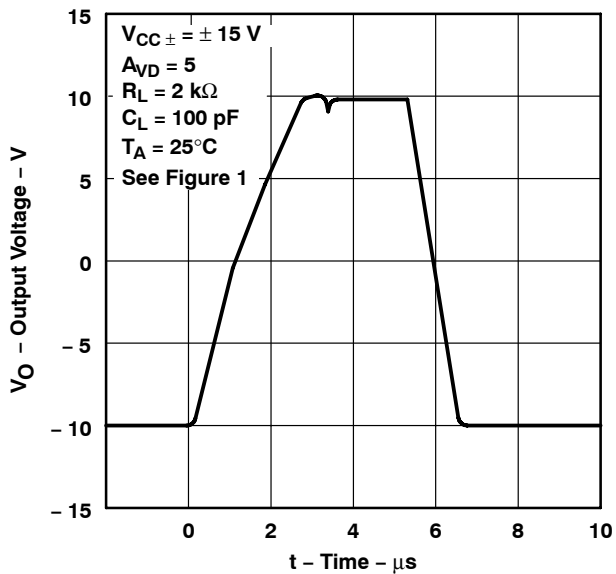

Figure 40

TYPICAL CHARACTERISTICS

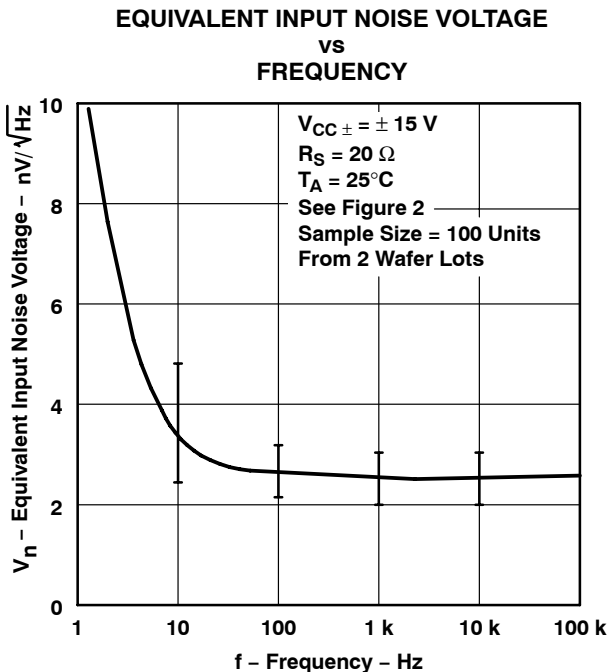

Figure 41

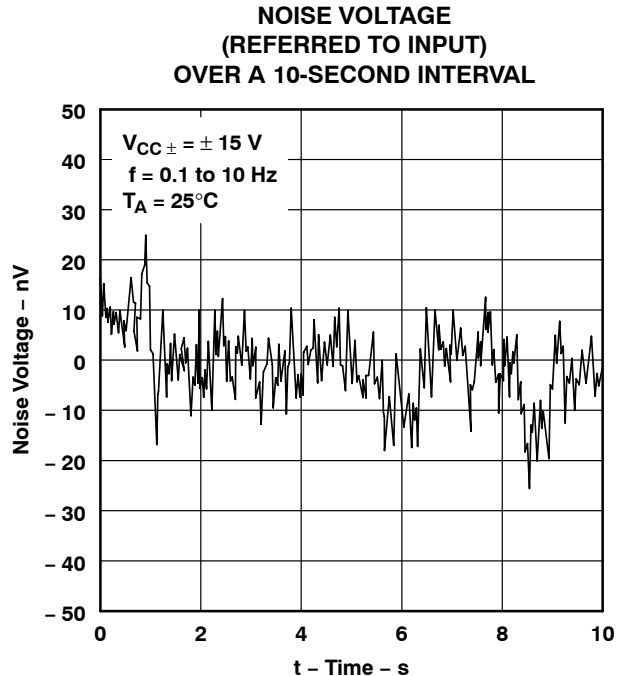

Figure 42

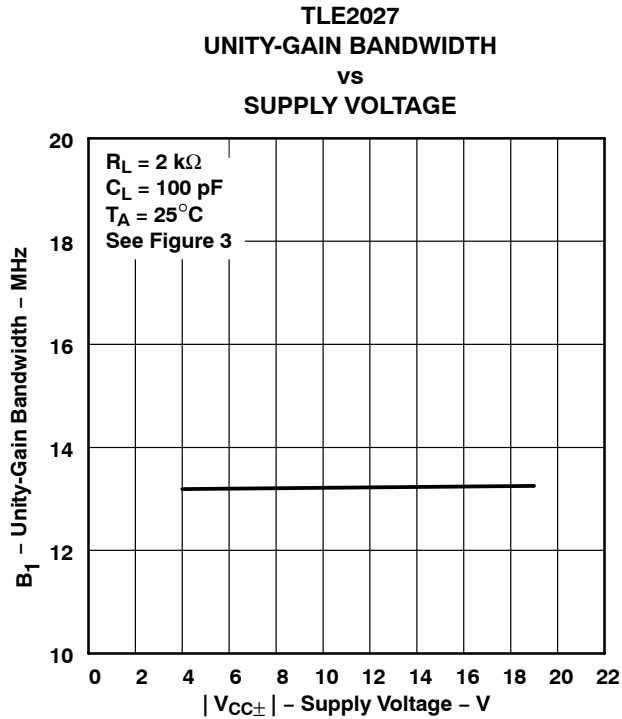

Figure 43

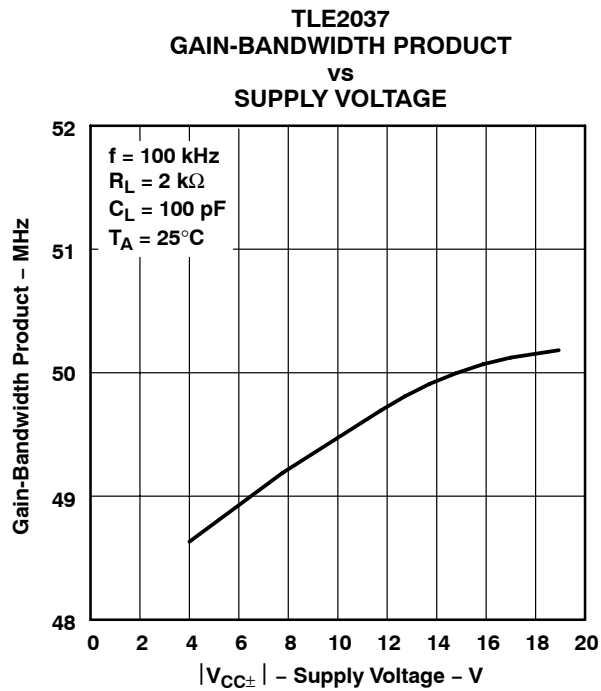

Figure 44

TLE2027, TLE2037, TLE2027A, TLE2037A, TLE2027Y, TLE2037Y EXCALIBUR LOW-NOISE HIGH-SPEED PRECISION OPERATIONAL AMPLIFIERS

SLOS192C – FEBRUARY 1997 – REVISED APRIL 2010

TYPICAL CHARACTERISTICS

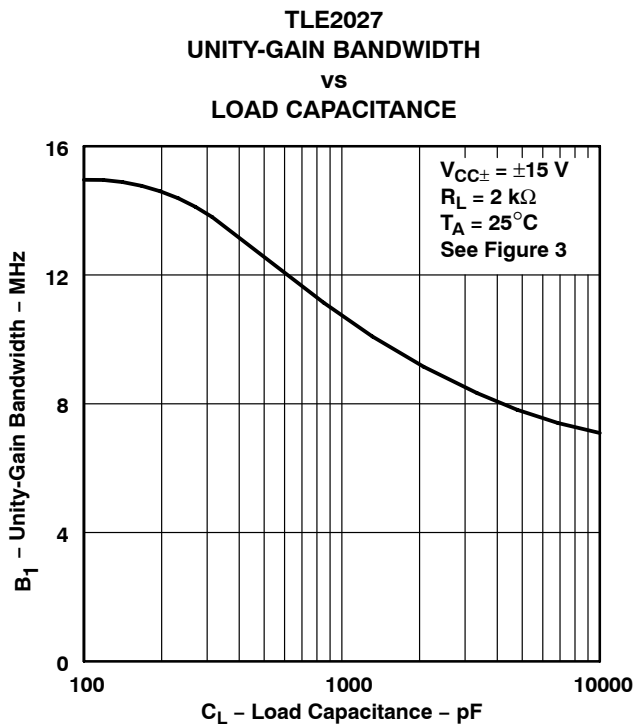

Figure 45

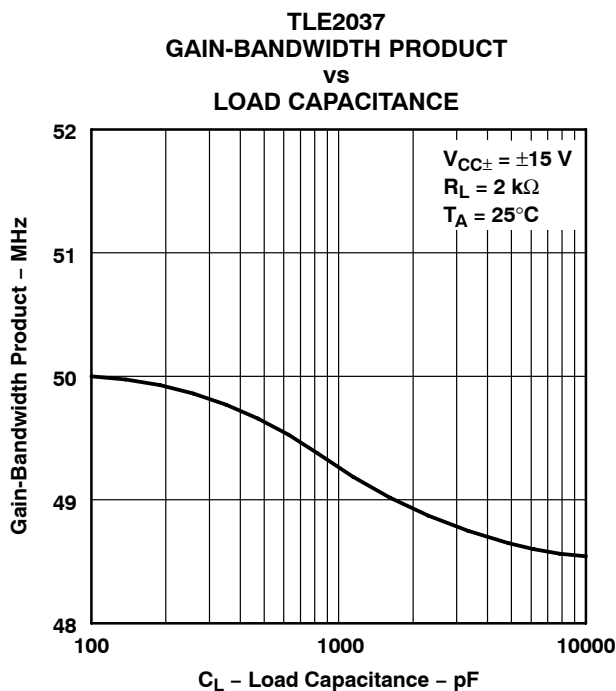

Figure 46

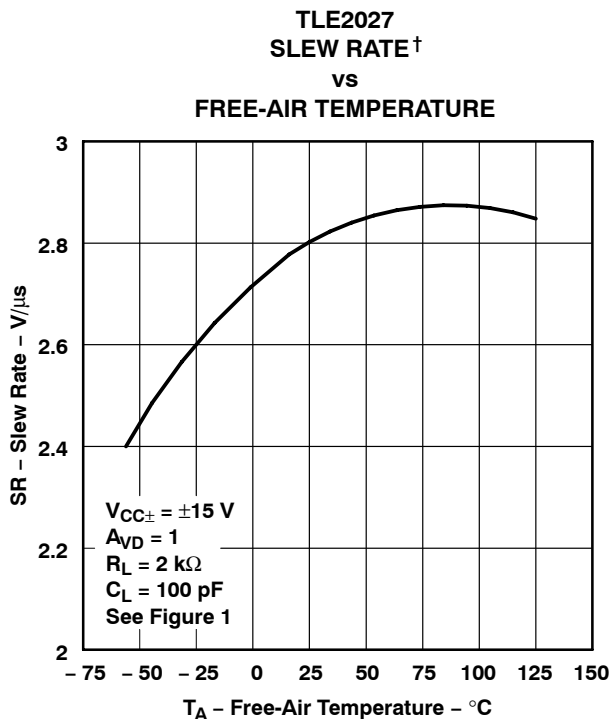

Figure 47

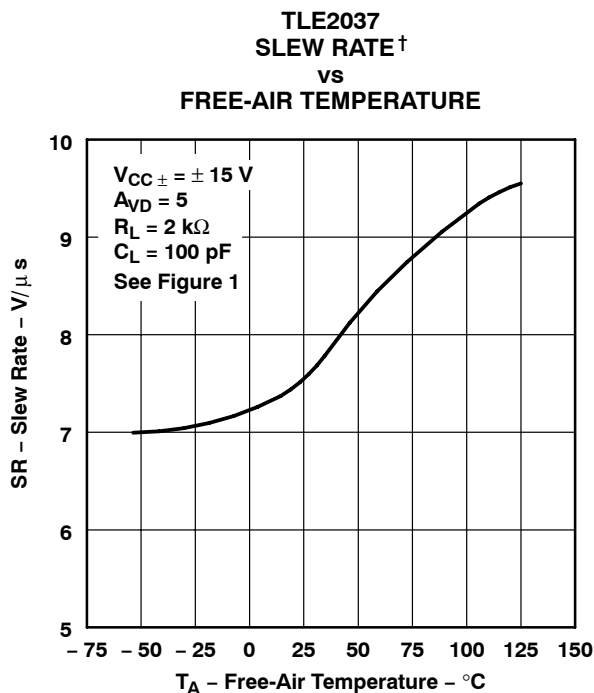

Figure 48

† Data at high and low temperatures are applicable only within the rated operating free-air temperature ranges of the various devices.

TYPICAL CHARACTERISTICS

TLE2027
 PHASE MARGIN
 vs
 SUPPLY VOLTAGE

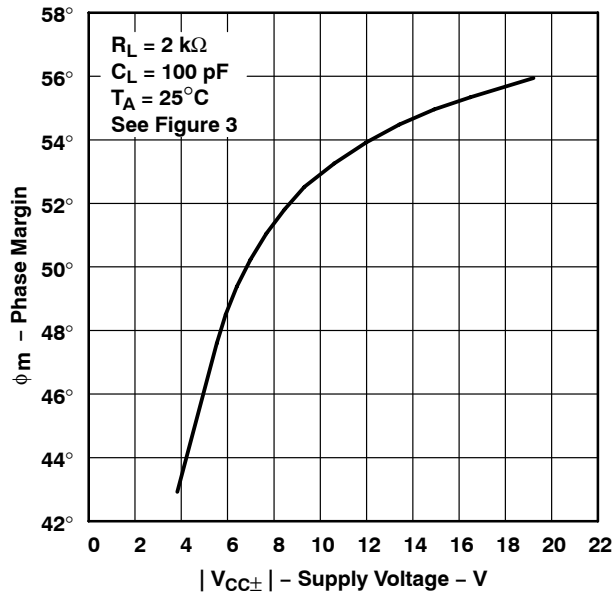

Figure 49

TLE2037
 PHASE MARGIN
 vs
 SUPPLY VOLTAGE

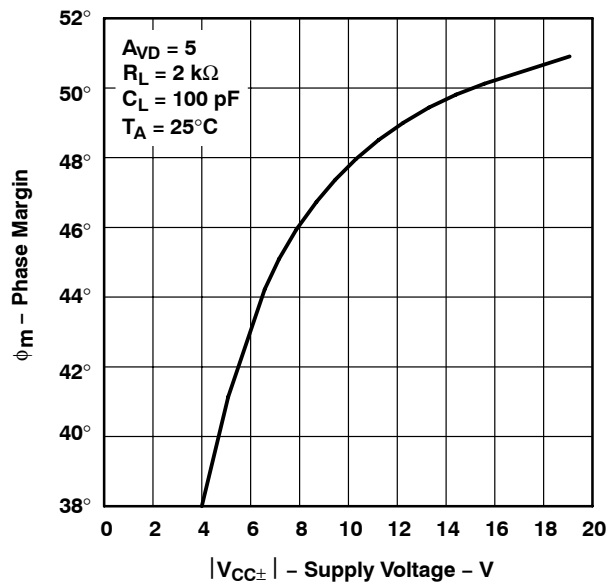

Figure 50

TLE2027
 PHASE MARGIN
 vs
 LOAD CAPACITANCE

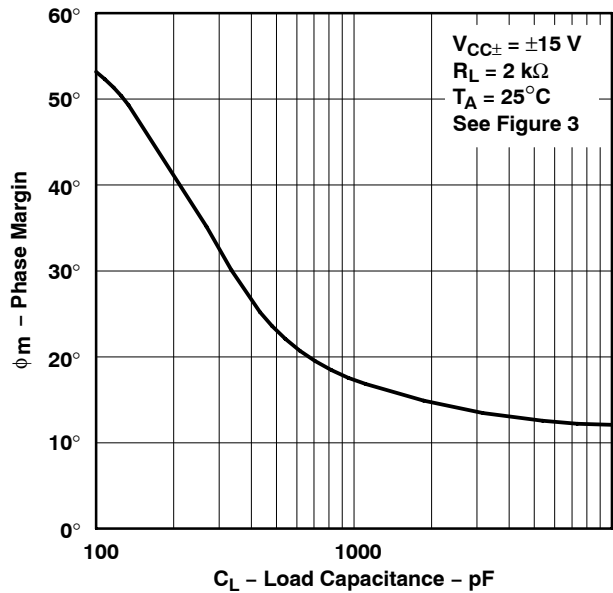

Figure 51

TLE2037
 PHASE MARGIN
 vs
 LOAD CAPACITANCE

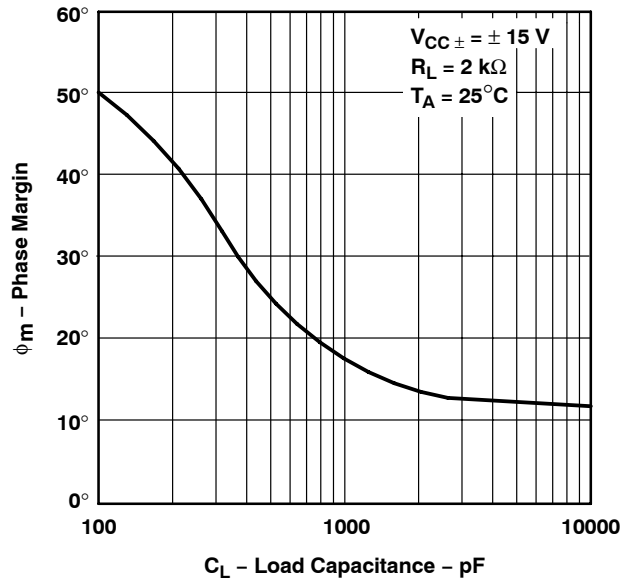

Figure 52

TLE2027, TLE2037, TLE2027A, TLE2037A, TLE2027Y, TLE2037Y
EXCALIBUR LOW-NOISE HIGH-SPEED
PRECISION OPERATIONAL AMPLIFIERS

SLOS192C – FEBRUARY 1997 – REVISED APRIL 2010

TYPICAL CHARACTERISTICS

TLE2027
PHASE MARGIN†
vs
FREE-AIR TEMPERATURE

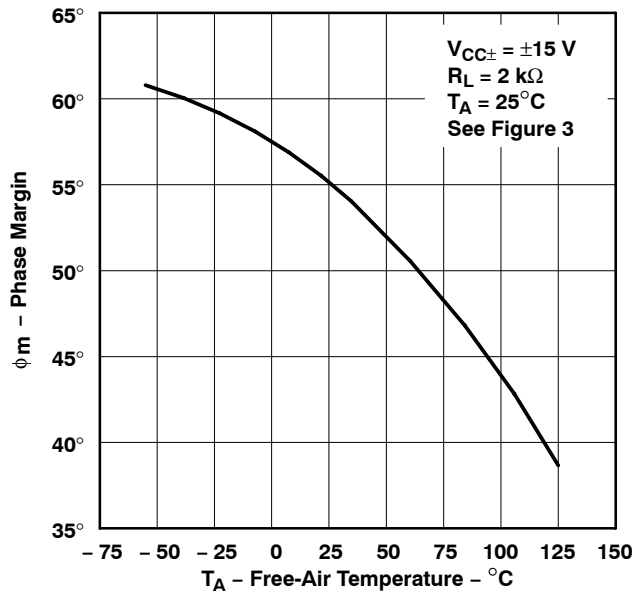

Figure 53

TLE2037
PHASE MARGIN†
vs
FREE-AIR TEMPERATURE

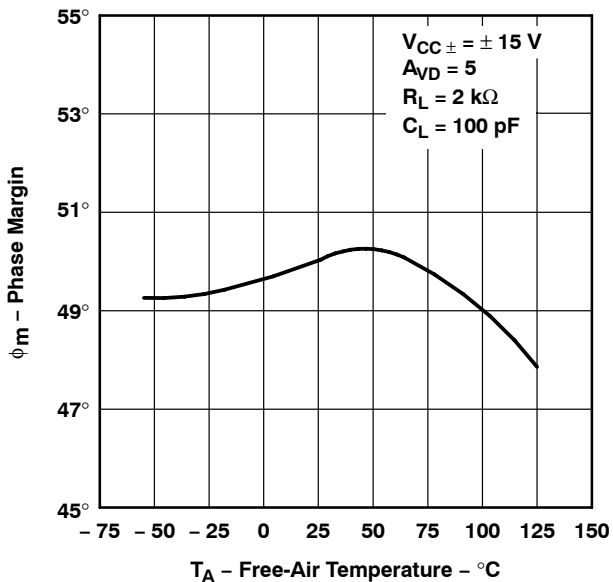

Figure 54

† Data at high and low temperatures are applicable only within the rated operating free-air temperature ranges of the various devices.

APPLICATION INFORMATION

input offset voltage nulling

The TLE2027 and TLE2037 series offers external null pins that can be used to further reduce the input offset voltage. The circuits of Figure 55 can be connected as shown if the feature is desired. If external nulling is not needed, the null pins may be left disconnected.

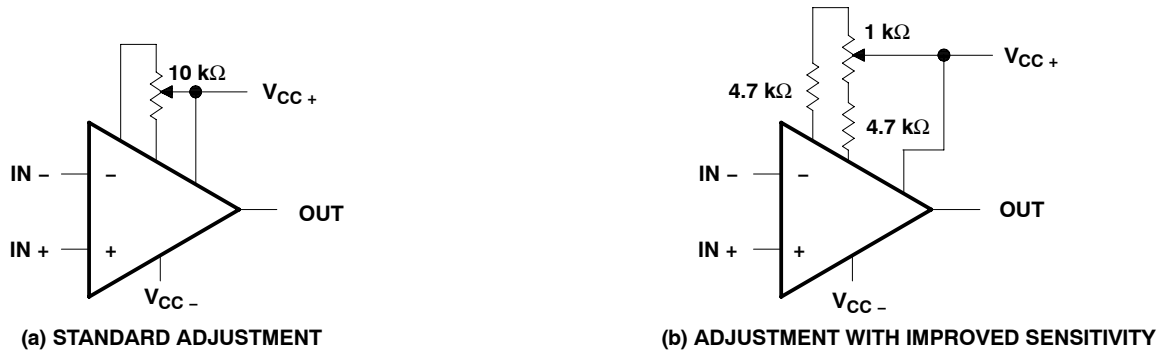

Figure 55. Input Offset Voltage Nulling Circuits

voltage-follower applications

The TLE2027 circuitry includes input-protection diodes to limit the voltage across the input transistors; however, no provision is made in the circuit to limit the current if these diodes are forward biased. This condition can occur when the device is operated in the voltage-follower configuration and driven with a fast, large-signal pulse. It is recommended that a feedback resistor be used to limit the current to a maximum of 1 mA to prevent degradation of the device. Also, this feedback resistor forms a pole with the input capacitance of the device. For feedback resistor values greater than 10 kΩ, this pole degrades the amplifier phase margin. This problem can be alleviated by adding a capacitor (20 pF to 50 pF) in parallel with the feedback resistor (see Figure 56).

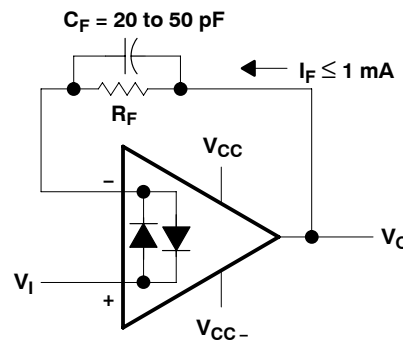

Figure 56. Voltage Follower

TLE2027, TLE2037, TLE2027A, TLE2037A, TLE2027Y, TLE2037Y EXCALIBUR LOW-NOISE HIGH-SPEED PRECISION OPERATIONAL AMPLIFIERS

SLOS192C – FEBRUARY 1997 – REVISED APRIL 2010

APPLICATION INFORMATION

macromodel information

Macromodel information provided was derived using Microsim *Parts*™, the model generation software used with Microsim *PSpice*™. The Boyle macromodel (see Note 6) and subcircuit in Figure 57, Figure 58, and Figure 59 were generated using the TLE20x7 typical electrical and operating characteristics at 25°C. Using this information, output simulations of the following key parameters can be generated to a tolerance of 20% (in most cases):

- Maximum positive output voltage swing
- Maximum negative output voltage swing
- Slew rate
- Quiescent power dissipation
- Input bias current
- Open-loop voltage amplification
- Gain-bandwidth product
- Common-mode rejection ratio
- Phase margin
- DC output resistance
- AC output resistance
- Short-circuit output current limit

NOTE 6: G. R. Boyle, B. M. Cohn, D. O. Pederson, and J. E. Solomon, "Macromodeling of Integrated Circuit Operational Amplifiers", IEEE Journal of Solid-State Circuits, SC-9, 353 (1974).

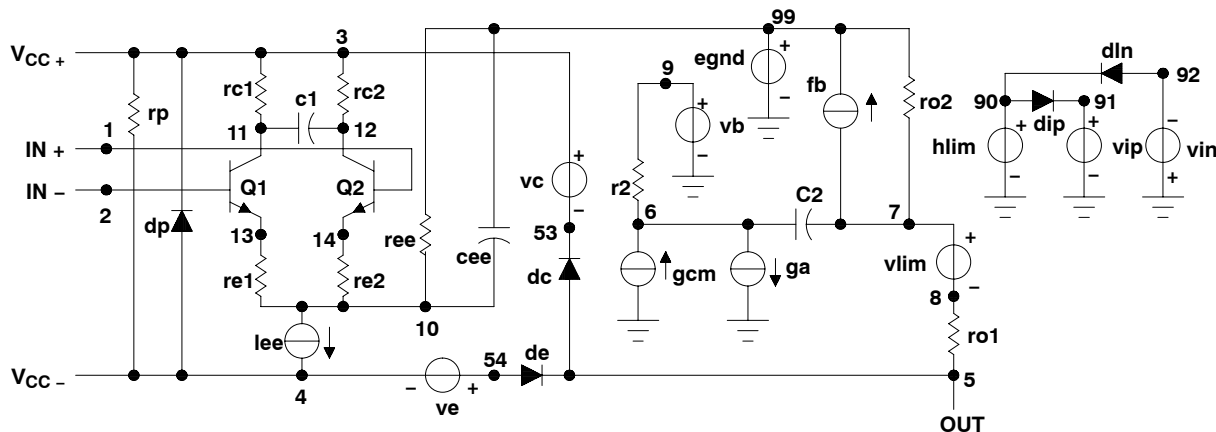

Figure 57. Boyle Macromodel

PSpice and *Parts* are trademarks of MicroSim Corporation.

APPLICATION INFORMATION

macromodel information (continued)

```
.subckt TLE2027 1 2 3 4 5
*
c1      11  12  4.003E-12
c2      6   7   20.00E-12
dc      5   53  dz
de      54  5   dz
dlp     90  91  dz
dln     92  90  dx
dp      4   3   dz
egnd    99   0   poly(2) (3,0)
(4,0) 0 5 .5
fb      7   99  poly(5) vb vc
ve vlp vln 0 954.8E6 -1E9 1E9 1E9
-1E9
ga      6   0   11  12
2.062E-3
gcm     0   6   10  99
531.3E-12
iee     10  4   dc 56.01E-6
hlim    90  0   vlim 1K
ql      11  2   13  qx
q2      12  1   14  qx
r2      6   9   100.0E3
rc1     3   11  530.5
rc2     3   12  530.5
re1     13  10  -393.2
re2     14  10  -393.2
ree     10  99  3.571E6
ro1     8   5   25
ro2     7   99  25
rp      3   4   8.013E3
vb      9   0   dc 0
vc      3   53  dc 2.400
ve      54  4   dc 2.100
vlim    7   8   dc 0
vlp     91  0   dc 40
vln     0   92  dc 40
.modeldx D(Is=800.0E-18)
.modelqx NPN(Is=800.0E-18
Bf=7.000E3)
.ends
```

Figure 58. TLE2027 Macromodel Subcircuit

```
.subckt TLE2037 1 2 3 4 5
*
c1      11  12  4.003E-12
c2      6   7   7.500E-12
dc      5   53  dz
de      54  5   dz
dlp     90  91  dz
dln     92  90  dx
dp      4   3   dz
egnd    99   0   poly(2) (3,0)
(4,0) 0 .5 .5
fb      7   99  poly(5) vb vc
ve vip vln 0 923.4E6 A800E6
800E6 800E6 A800E6
ga      6   0   11  12 2.121E-3
gcm     0   6   10  99 597.7E-12
iee     10  4   dc 56.26E-6
hlim    90  0   vlim 1K
ql      11  2   13  qx
q2      12  1   14  qz
r2      6   9   100.0E3
rc1     3   11  471.5
rc2     3   12  471.5
re1     13  10  A448
re2     14  10  A448
ree     10  99  3.555E6
ro1     8   5   25
ro2     7   99  25
rp      3   4   8.013E3
vb      9   0   dc 0
vc      3   53  dc 2.400
ve      54  4   dc 2.100
vlim    7   8   dc 0
vlp     91  0   dc 40
vln     0   92  dc 40
.model  dxD(Is=800.0E-18)
.model  qxNPN(Is=800.0E-18
Bf=7.031E3)
.ends
```

Figure 59. TLE2037 Macromodel Subcircuit

TLE2027, TLE2037, TLE2027A, TLE2037A, TLE2027Y, TLE2037Y
EXCALIBUR LOW-NOISE HIGH-SPEED
PRECISION OPERATIONAL AMPLIFIERS

SLOS192C – FEBRUARY 1997 – REVISED APRIL 2010

REVISION HISTORY

Changes from Revision B (October 2006) to Revision C

- Changed values of V_n , $V_{N(PP)}$, and I_n 11

PACKAGING INFORMATION

| Orderable Device | Status (1) | Package Type | Package Drawing | Pins | Package Qty | Eco Plan (2) | Lead finish/ Ball material (6) | MSL Peak Temp (3) | Op Temp (°C) | Device Marking (4/5) | Samples |
|------------------|---------------|--------------|-----------------|------|-------------|------------------|--------------------------------------|----------------------|--------------|---------------------------------|-------------------------|
| 5962-9089601M2A | ACTIVE | LCCC | FK | 20 | 55 | Non-RoHS & Green | SNPB | N / A for Pkg Type | -55 to 125 | 5962-9089601M2A TLE2027MFKB | Samples |
| 5962-9089601MPA | ACTIVE | CDIP | JG | 8 | 50 | Non-RoHS & Green | SNPB | N / A for Pkg Type | -55 to 125 | 9089601MPA TLE2027M | Samples |
| 5962-9089603Q2A | ACTIVE | LCCC | FK | 20 | 55 | Non-RoHS & Green | SNPB | N / A for Pkg Type | -55 to 125 | 5962-9089603Q2A TLE2027AMFKB | Samples |
| 5962-9089603QPA | ACTIVE | CDIP | JG | 8 | 50 | Non-RoHS & Green | SNPB | N / A for Pkg Type | -55 to 125 | 9089603QPA TLE2027AM | Samples |
| TLE2027AMD | ACTIVE | SOIC | D | 8 | 75 | RoHS & Green | NIPDAU | Level-1-260C-UNLIM | -55 to 125 | 2027AM | Samples |
| TLE2027AMFKB | ACTIVE | LCCC | FK | 20 | 55 | Non-RoHS & Green | SNPB | N / A for Pkg Type | -55 to 125 | 5962-9089603Q2A TLE2027AMFKB | Samples |
| TLE2027AMJG | ACTIVE | CDIP | JG | 8 | 50 | Non-RoHS & Green | SNPB | N / A for Pkg Type | -55 to 125 | TLE2027 AMJG | Samples |
| TLE2027AMJGB | ACTIVE | CDIP | JG | 8 | 50 | Non-RoHS & Green | SNPB | N / A for Pkg Type | -55 to 125 | 9089603QPA TLE2027AM | Samples |
| TLE2027CD | ACTIVE | SOIC | D | 8 | 75 | RoHS & Green | NIPDAU | Level-1-260C-UNLIM | | 2027C | Samples |
| TLE2027CDR | ACTIVE | SOIC | D | 8 | 2500 | RoHS & Green | NIPDAU | Level-1-260C-UNLIM | 0 to 70 | 2027C | Samples |
| TLE2027ID | ACTIVE | SOIC | D | 8 | 75 | RoHS & Green | NIPDAU | Level-1-260C-UNLIM | | 2027I | Samples |
| TLE2027IDR | ACTIVE | SOIC | D | 8 | 2500 | RoHS & Green | NIPDAU | Level-1-260C-UNLIM | | 2027I | Samples |
| TLE2027MD | ACTIVE | SOIC | D | 8 | 75 | RoHS & Green | NIPDAU | Level-1-260C-UNLIM | -55 to 125 | 2027M | Samples |
| TLE2027MFKB | ACTIVE | LCCC | FK | 20 | 55 | Non-RoHS & Green | SNPB | N / A for Pkg Type | -55 to 125 | 5962-9089601M2A TLE2027MFKB | Samples |
| TLE2027MJGB | ACTIVE | CDIP | JG | 8 | 50 | Non-RoHS & Green | SNPB | N / A for Pkg Type | -55 to 125 | 9089601MPA TLE2027M | Samples |
| TLE2037AMD | ACTIVE | SOIC | D | 8 | 75 | RoHS & Green | NIPDAU | Level-1-260C-UNLIM | -55 to 125 | 2037AM | Samples |

| Orderable Device | Status (1) | Package Type | Package Drawing | Pins | Package Qty | Eco Plan (2) | Lead finish/ Ball material (6) | MSL Peak Temp (3) | Op Temp (°C) | Device Marking (4/5) | Samples |
|------------------|---------------|--------------|-----------------|------|-------------|-----------------|--------------------------------------|----------------------|--------------|-------------------------|-------------------------|
| TLE2037AMDG4 | ACTIVE | SOIC | D | 8 | 75 | RoHS & Green | NIPDAU | Level-1-260C-UNLIM | -55 to 125 | 2037AM | Samples |
| TLE2037CD | ACTIVE | SOIC | D | 8 | 75 | RoHS & Green | NIPDAU | Level-1-260C-UNLIM | | 2037C | Samples |
| TLE2037CDR | ACTIVE | SOIC | D | 8 | 2500 | RoHS & Green | NIPDAU | Level-1-260C-UNLIM | | 2037C | Samples |
| TLE2037ID | ACTIVE | SOIC | D | 8 | 75 | RoHS & Green | NIPDAU | Level-1-260C-UNLIM | | 2037I | Samples |
| TLE2037IDR | ACTIVE | SOIC | D | 8 | 2500 | RoHS & Green | NIPDAU | Level-1-260C-UNLIM | | 2037I | Samples |
| TLE2037MD | ACTIVE | SOIC | D | 8 | 75 | RoHS & Green | NIPDAU | Level-1-260C-UNLIM | -55 to 125 | 2037M | Samples |

(1) The marketing status values are defined as follows:

ACTIVE: Product device recommended for new designs.

LIFEBUY: TI has announced that the device will be discontinued, and a lifetime-buy period is in effect.

NRND: Not recommended for new designs. Device is in production to support existing customers, but TI does not recommend using this part in a new design.

PREVIEW: Device has been announced but is not in production. Samples may or may not be available.

OBSELETE: TI has discontinued the production of the device.

(2) **RoHS:** TI defines "RoHS" to mean semiconductor products that are compliant with the current EU RoHS requirements for all 10 RoHS substances, including the requirement that RoHS substance do not exceed 0.1% by weight in homogeneous materials. Where designed to be soldered at high temperatures, "RoHS" products are suitable for use in specified lead-free processes. TI may reference these types of products as "Pb-Free".

RoHS Exempt: TI defines "RoHS Exempt" to mean products that contain lead but are compliant with EU RoHS pursuant to a specific EU RoHS exemption.

Green: TI defines "Green" to mean the content of Chlorine (Cl) and Bromine (Br) based flame retardants meet JS709B low halogen requirements of <=1000ppm threshold. Antimony trioxide based flame retardants must also meet the <=1000ppm threshold requirement.

(3) MSL, Peak Temp. - The Moisture Sensitivity Level rating according to the JEDEC industry standard classifications, and peak solder temperature.

(4) There may be additional marking, which relates to the logo, the lot trace code information, or the environmental category on the device.

(5) Multiple Device Markings will be inside parentheses. Only one Device Marking contained in parentheses and separated by a "~" will appear on a device. If a line is indented then it is a continuation of the previous line and the two combined represent the entire Device Marking for that device.

(6) Lead finish/Ball material - Orderable Devices may have multiple material finish options. Finish options are separated by a vertical ruled line. Lead finish/Ball material values may wrap to two lines if the finish value exceeds the maximum column width.

Important Information and Disclaimer:The information provided on this page represents TI's knowledge and belief as of the date that it is provided. TI bases its knowledge and belief on information provided by third parties, and makes no representation or warranty as to the accuracy of such information. Efforts are underway to better integrate information from third parties. TI has taken and continues to take reasonable steps to provide representative and accurate information but may not have conducted destructive testing or chemical analysis on incoming materials and chemicals. TI and TI suppliers consider certain information to be proprietary, and thus CAS numbers and other limited information may not be available for release.

In no event shall TI's liability arising out of such information exceed the total purchase price of the TI part(s) at issue in this document sold by TI to Customer on an annual basis.

OTHER QUALIFIED VERSIONS OF TLE2027, TLE2027M, TLE2037A :

- Catalog : [TLE2027](#)
- Automotive : [TLE2037A-Q1](#)
- Enhanced Product : [TLE2027-EP](#), [TLE2027-EP](#)
- Military : [TLE2027M](#)

NOTE: Qualified Version Definitions:

- Catalog - TI's standard catalog product
- Automotive - Q100 devices qualified for high-reliability automotive applications targeting zero defects
- Enhanced Product - Supports Defense, Aerospace and Medical Applications
- Military - QML certified for Military and Defense Applications

TAPE AND REEL INFORMATION

QUADRANT ASSIGNMENTS FOR PIN 1 ORIENTATION IN TAPE

*All dimensions are nominal

| Device | Package Type | Package Drawing | Pins | SPQ | Reel Diameter (mm) | Reel Width W1 (mm) | A0 (mm) | B0 (mm) | K0 (mm) | P1 (mm) | W (mm) | Pin1 Quadrant |
|------------|--------------|-----------------|------|------|--------------------|--------------------|---------|---------|---------|---------|--------|---------------|
| TLE2027CDR | SOIC | D | 8 | 2500 | 330.0 | 12.4 | 6.4 | 5.2 | 2.1 | 8.0 | 12.0 | Q1 |
| TLE2027IDR | SOIC | D | 8 | 2500 | 330.0 | 12.4 | 6.4 | 5.2 | 2.1 | 8.0 | 12.0 | Q1 |
| TLE2037CDR | SOIC | D | 8 | 2500 | 330.0 | 12.4 | 6.4 | 5.2 | 2.1 | 8.0 | 12.0 | Q1 |
| TLE2037IDR | SOIC | D | 8 | 2500 | 330.0 | 12.4 | 6.4 | 5.2 | 2.1 | 8.0 | 12.0 | Q1 |

TAPE AND REEL BOX DIMENSIONS

*All dimensions are nominal

| Device | Package Type | Package Drawing | Pins | SPQ | Length (mm) | Width (mm) | Height (mm) |
|------------|--------------|-----------------|------|------|-------------|------------|-------------|
| TLE2027CDR | SOIC | D | 8 | 2500 | 340.5 | 338.1 | 20.6 |
| TLE2027IDR | SOIC | D | 8 | 2500 | 340.5 | 338.1 | 20.6 |
| TLE2037CDR | SOIC | D | 8 | 2500 | 340.5 | 338.1 | 20.6 |
| TLE2037IDR | SOIC | D | 8 | 2500 | 340.5 | 338.1 | 20.6 |

TUBE

*All dimensions are nominal

| Device | Package Name | Package Type | Pins | SPQ | L (mm) | W (mm) | T (μm) | B (mm) |
|-----------------|--------------|--------------|------|-----|--------|--------|--------|--------|
| 5962-9089601M2A | FK | LCCC | 20 | 55 | 506.98 | 12.06 | 2030 | NA |
| 5962-9089603Q2A | FK | LCCC | 20 | 55 | 506.98 | 12.06 | 2030 | NA |
| TLE2027AMD | D | SOIC | 8 | 75 | 505.46 | 6.76 | 3810 | 4 |
| TLE2027AMFKB | FK | LCCC | 20 | 55 | 506.98 | 12.06 | 2030 | NA |
| TLE2027CD | D | SOIC | 8 | 75 | 507 | 8 | 3940 | 4.32 |
| TLE2027CD | D | SOIC | 8 | 75 | 505.46 | 6.76 | 3810 | 4 |
| TLE2027ID | D | SOIC | 8 | 75 | 507 | 8 | 3940 | 4.32 |
| TLE2027ID | D | SOIC | 8 | 75 | 505.46 | 6.76 | 3810 | 4 |
| TLE2027MD | D | SOIC | 8 | 75 | 505.46 | 6.76 | 3810 | 4 |
| TLE2027MFKB | FK | LCCC | 20 | 55 | 506.98 | 12.06 | 2030 | NA |
| TLE2037AMD | D | SOIC | 8 | 75 | 505.46 | 6.76 | 3810 | 4 |
| TLE2037AMDG4 | D | SOIC | 8 | 75 | 505.46 | 6.76 | 3810 | 4 |
| TLE2037CD | D | SOIC | 8 | 75 | 507 | 8 | 3940 | 4.32 |
| TLE2037CD | D | SOIC | 8 | 75 | 505.46 | 6.76 | 3810 | 4 |
| TLE2037ID | D | SOIC | 8 | 75 | 507 | 8 | 3940 | 4.32 |
| TLE2037ID | D | SOIC | 8 | 75 | 505.46 | 6.76 | 3810 | 4 |
| TLE2037MD | D | SOIC | 8 | 75 | 505.46 | 6.76 | 3810 | 4 |

GENERIC PACKAGE VIEW

FK 20

LCCC - 2.03 mm max height

8.89 x 8.89, 1.27 mm pitch

LEADLESS CERAMIC CHIP CARRIER

This image is a representation of the package family, actual package may vary.
Refer to the product data sheet for package details.



4229370VA\



D0008A

PACKAGE OUTLINE

SOIC - 1.75 mm max height

SMALL OUTLINE INTEGRATED CIRCUIT



4214825/C 02/2019

NOTES:

- Linear dimensions are in inches [millimeters]. Dimensions in parenthesis are for reference only. Controlling dimensions are in inches. Dimensioning and tolerancing per ASME Y14.5M.
- This drawing is subject to change without notice.
- This dimension does not include mold flash, protrusions, or gate burrs. Mold flash, protrusions, or gate burrs shall not exceed $.006$ [0.15] per side.
- This dimension does not include interlead flash.
- Reference JEDEC registration MS-012, variation AA.

EXAMPLE BOARD LAYOUT

D0008A

SOIC - 1.75 mm max height

SMALL OUTLINE INTEGRATED CIRCUIT



LAND PATTERN EXAMPLE
EXPOSED METAL SHOWN
SCALE:8X



SOLDER MASK DETAILS

4214825/C 02/2019

NOTES: (continued)

- 6. Publication IPC-7351 may have alternate designs.
- 7. Solder mask tolerances between and around signal pads can vary based on board fabrication site.

EXAMPLE STENCIL DESIGN

D0008A

SOIC - 1.75 mm max height

SMALL OUTLINE INTEGRATED CIRCUIT



SOLDER PASTE EXAMPLE
BASED ON .005 INCH [0.125 MM] THICK STENCIL
SCALE:8X

4214825/C 02/2019

NOTES: (continued)

8. Laser cutting apertures with trapezoidal walls and rounded corners may offer better paste release. IPC-7525 may have alternate design recommendations.
9. Board assembly site may have different recommendations for stencil design.

PACKAGE OUTLINE

JG0008A

CDIP - 5.08 mm max height

CERAMIC DUAL IN-LINE PACKAGE



NOTES:

1. All linear dimensions are in millimeters. Any dimensions in parenthesis are for reference only. Dimensioning and tolerancing per ASME Y14.5M.
2. This drawing is subject to change without notice.
3. This package can be hermetically sealed with a ceramic lid using glass frit.
4. Index point is provided on cap for terminal identification.
5. Falls within MIL STD 1835 GDIP1-T8

EXAMPLE BOARD LAYOUT

JG0008A

CDIP - 5.08 mm max height

CERAMIC DUAL IN-LINE PACKAGE

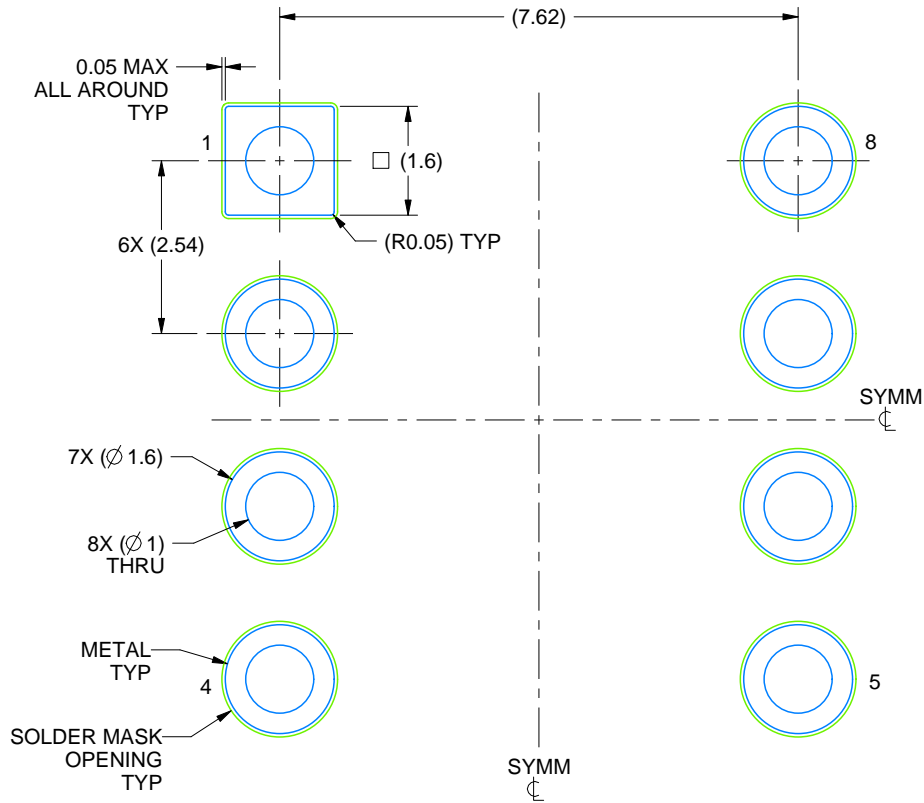

LAND PATTERN EXAMPLE
NON SOLDER MASK DEFINED
SCALE: 9X

4230036/A 09/2023

IMPORTANT NOTICE AND DISCLAIMER

TI PROVIDES TECHNICAL AND RELIABILITY DATA (INCLUDING DATA SHEETS), DESIGN RESOURCES (INCLUDING REFERENCE DESIGNS), APPLICATION OR OTHER DESIGN ADVICE, WEB TOOLS, SAFETY INFORMATION, AND OTHER RESOURCES "AS IS" AND WITH ALL FAULTS, AND DISCLAIMS ALL WARRANTIES, EXPRESS AND IMPLIED, INCLUDING WITHOUT LIMITATION ANY IMPLIED WARRANTIES OF MERCHANTABILITY, FITNESS FOR A PARTICULAR PURPOSE OR NON-INFRINGEMENT OF THIRD PARTY INTELLECTUAL PROPERTY RIGHTS.

These resources are intended for skilled developers designing with TI products. You are solely responsible for (1) selecting the appropriate TI products for your application, (2) designing, validating and testing your application, and (3) ensuring your application meets applicable standards, and any other safety, security, regulatory or other requirements.

These resources are subject to change without notice. TI grants you permission to use these resources only for development of an application that uses the TI products described in the resource. Other reproduction and display of these resources is prohibited. No license is granted to any other TI intellectual property right or to any third party intellectual property right. TI disclaims responsibility for, and you will fully indemnify TI and its representatives against, any claims, damages, costs, losses, and liabilities arising out of your use of these resources.

TI's products are provided subject to [TI's Terms of Sale](#) or other applicable terms available either on [ti.com](https://www.ti.com) or provided in conjunction with such TI products. TI's provision of these resources does not expand or otherwise alter TI's applicable warranties or warranty disclaimers for TI products.

TI objects to and rejects any additional or different terms you may have proposed.

Mailing Address: Texas Instruments, Post Office Box 655303, Dallas, Texas 75265
Copyright © 2024, Texas Instruments Incorporated