

# TLV2401, TLV2402, TLV2404 FAMILY OF 880-nA/Ch RAIL-TO-RAIL INPUT/OUTPUT OPERATIONAL AMPLIFIERS WITH REVERSE BATTERY PROTECTION

SLOS244B – FEBRUARY 2000 – REVISED NOVEMBER 2000

- **Micro-Power Operation . . . < 1  $\mu$ A/Channel**
- **Input Common-Mode Range Exceeds the Rails . . . -0.1 V to  $V_{CC} + 5$  V**
- **Reverse Battery Protection Up To 18 V**
- **Rail-to-Rail Input/Output**
- **Gain Bandwidth Product . . . 5.5 kHz**
- **Supply Voltage Range . . . 2.5 V to 16 V**
- **Specified Temperature Range**
  - $T_A = 0^\circ\text{C}$  to  $70^\circ\text{C}$  . . . Commercial Grade
  - $T_A = -40^\circ\text{C}$  to  $125^\circ\text{C}$  . . . Industrial Grade
- **Ultrasmall Packaging**
  - 5-Pin SOT-23 (TLV2401)
  - 8-Pin MSOP (TLV2402)
- **Universal OpAmp EVM (Refer to the EVM Selection Guide SLOU060)**

Operational Amplifier

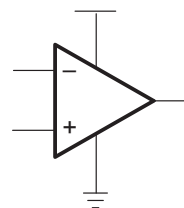

**SUPPLY CURRENT  
vs  
SUPPLY VOLTAGE**

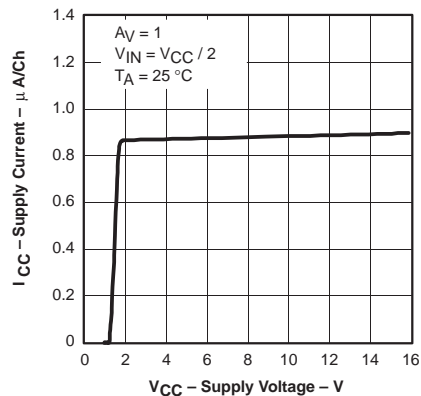

## description

The TLV240x family of single-supply operational amplifiers has the lowest supply current available today at only 880 nA per channel. Reverse battery protection guards the amplifier from an over-current condition due to improper battery installation. For harsh environments, the inputs can be taken 5 V above the positive supply rail without damage to the device.

The low supply current is coupled with extremely low input bias currents enabling them to be used with mega- $\Omega$  resistors making them ideal for portable, long active life, applications. DC accuracy is ensured with a low typical offset voltage as low as 390  $\mu$ V, CMRR of 120 dB and minimum open loop gain of 130 V/mV at 2.7 V.

The maximum recommended supply voltage is as high as 16 V and ensured operation down to 2.5 V, with electrical characteristics specified at 2.7 V, 5 V and 15 V. The 2.5-V operation makes it compatible with Li-Ion battery-powered systems and many micro-power microcontrollers available today including TI's MSP430.

All members are available in PDIP and SOIC with the singles in the small SOT-23 package, duals in the MSOP, and quads in TSSOP.

### SELECTION OF SINGLE SUPPLY OPERATIONAL AMPLIFIER PRODUCTS†

DEVICE	$V_{CC}$ (V)	$V_{IO}$ (mV)	BW (MHz)	SLEW RATE (V/ $\mu$ s)	$I_{CC}/ch$ ( $\mu$ A)	RAIL-TO-RAIL
TLV240x‡	2.5–16	0.390	0.005	0.002	0.880	I/O
TLV224x	2.5–12	0.600	0.005	0.002	1	I/O
TLV2211	2.7–10	0.450	0.065	0.025	13	O
TLV245x	2.7–6	0.020	0.22	0.110	23	I/O
TLV225x	2.7–8	0.200	0.2	0.12	35	O

† All specifications are typical values measured at 5 V.

‡ This device also offers 18-V reverse battery protection and 5-V over-the-rail operation on the inputs.



Please be aware that an important notice concerning availability, standard warranty, and use in critical applications of Texas Instruments semiconductor products and disclaimers thereto appears at the end of this data sheet.

PRODUCTION DATA information is current as of publication date. Products conform to specifications per the terms of Texas Instruments standard warranty. Production processing does not necessarily include testing of all parameters.

**TEXAS  
INSTRUMENTS**

POST OFFICE BOX 655303 • DALLAS, TEXAS 75265

Copyright © 2000, Texas Instruments Incorporated

# TLV2401, TLV2402, TLV2404

## FAMILY OF 880-nA/Ch RAIL-TO-RAIL INPUT/OUTPUT

### OPERATIONAL AMPLIFIERS WITH REVERSE BATTERY PROTECTION

SLOS244B – FEBRUARY 2000 – REVISED NOVEMBER 2000

#### TLV2401 AVAILABLE OPTIONS

T <sub>A</sub>	V <sub>IOmax</sub> AT 25°C	PACKAGED DEVICES			
		SMALL OUTLINE† (D)	SOT-23† (DBV)	SYMBOLS	PLASTIC DIP (P)
0°C to 70°C	1500 μV	TLV2401CD	TLV2401CDBV	VAWC	—
-40°C to 125°C		TLV2401ID	TLV2401IDBV	VAWI	TLV2401IP

† This package is available taped and reeled. To order this packaging option, add an R suffix to the part number (e.g., TLV2401CDR).

#### TLV2402 AVAILABLE OPTIONS

T <sub>A</sub>	V <sub>IOmax</sub> AT 25°C	PACKAGED DEVICES			
		SMALL OUTLINE† (D)	MSOP† (DGK)	SYMBOLS	PLASTIC DIP (P)
0°C to 70°C	1500 μV	TLV2402CD	TLV2402CDGK	xxTIAIX	—
-40°C to 125°C		TLV2402ID	TLV2402IDGK	xxTIAIY	TLV2402IP

† This package is available taped and reeled. To order this packaging option, add an R suffix to the part number (e.g., TLV2402CDR).

#### TLV2404 AVAILABLE OPTIONS

T <sub>A</sub>	V <sub>IOmax</sub> AT 25°C	PACKAGED DEVICES		
		SMALL OUTLINE† (D)	PLASTIC DIP (N)	TSSOP (PW)
0°C to 70°C	1500 μV	TLV2404CD	TLV2404CN	TLV2404CPW
-40°C to 125°C		TLV2404ID	TLV2404IN	TLV2404IPW

† This package is available taped and reeled. To order this packaging option, add an R suffix to the part number (e.g., TLV2404CDR).

#### TLV240x PACKAGE PINOUTS

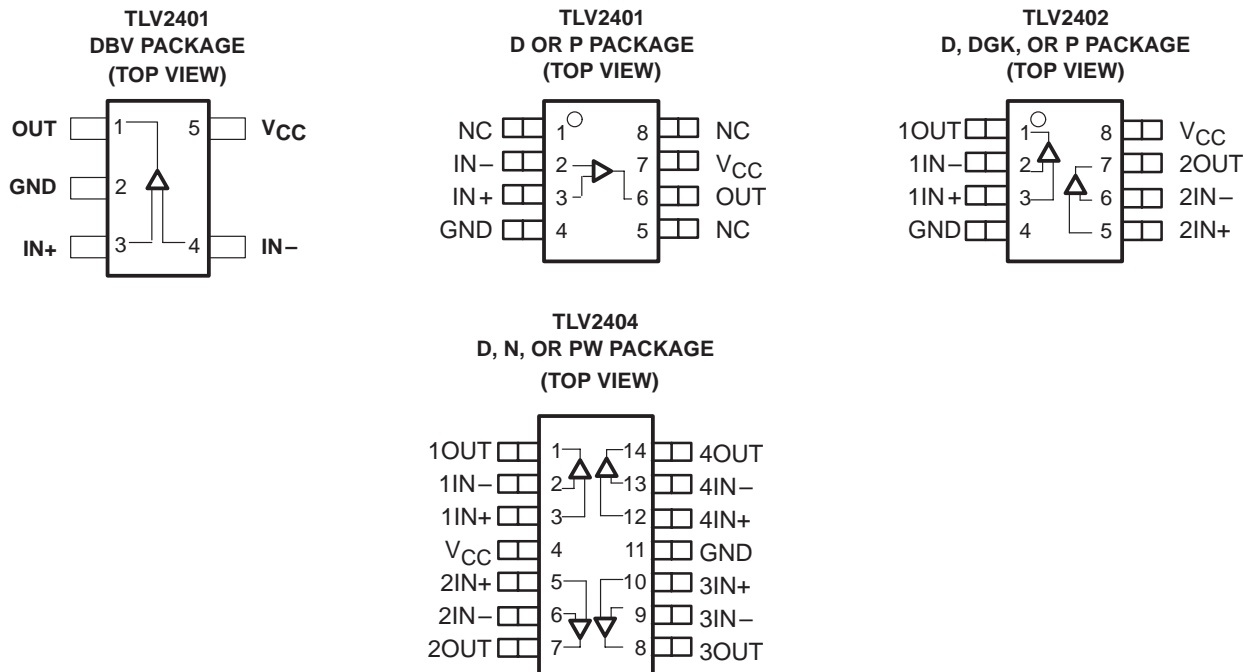

NC – No internal connection



TLV2401, TLV2402, TLV2404  
**FAMILY OF 880-nA/Ch RAIL-TO-RAIL INPUT/OUTPUT  
 OPERATIONAL AMPLIFIERS WITH REVERSE BATTERY PROTECTION**

SLOS244B – FEBRUARY 2000 – REVISED NOVEMBER 2000

**absolute maximum ratings over operating free-air temperature range (unless otherwise noted)†**

Supply voltage, $V_{CC}$ (see Note 1)	17 V
Differential input voltage range, $V_{ID}$	$\pm 20$ V
Input current range, $I_I$ (any input)	$\pm 10$ mA
Output current range, $I_O$	$\pm 10$ mA
Continuous total power dissipation	See Dissipation Rating Table
Operating free-air temperature range, $T_A$ : C suffix	$0^\circ\text{C}$ to $70^\circ\text{C}$
I suffix	$-40^\circ\text{C}$ to $125^\circ\text{C}$
Maximum junction temperature, $T_J$	$150^\circ\text{C}$
Storage temperature range, $T_{stg}$	$-65^\circ\text{C}$ to $150^\circ\text{C}$
Lead temperature 1,6 mm (1/16 inch) from case for 10 seconds	$260^\circ\text{C}$

† Stresses beyond those listed under “absolute maximum ratings” may cause permanent damage to the device. These are stress ratings only, and functional operation of the device at these or any other conditions beyond those indicated under “recommended operating conditions” is not implied. Exposure to absolute-maximum-rated conditions for extended periods may affect device reliability.

NOTE 1: All voltage values, except differential voltages, are with respect to GND

**DISSIPATION RATING TABLE**

PACKAGE	$\Theta_{JC}$ ( $^\circ\text{C}/\text{W}$ )	$\Theta_{JA}$ ( $^\circ\text{C}/\text{W}$ )	$T_A \leq 25^\circ\text{C}$ POWER RATING	$T_A = 125^\circ\text{C}$ POWER RATING
D (8)	38.3	176	710 mW	142 mW
D (14)	26.9	122.6	1022 mW	204.4 mW
DBV (5)	55	324.1	385 mW	77.1 mW
DGK (8)	54.2	259.9	481 mW	96.2 mW
N (14)	32	78	1600 mW	320.5 mW
P (8)	41	104	1200 mW	240.4 mW
PW (14)	29.3	173.6	720 mW	144 mW

**recommended operating conditions**

		MIN	MAX	UNIT
Supply voltage, $V_{CC}$	Single supply	2.5	16	V
	Split supply	$\pm 1.25$	$\pm 8$	
Common-mode input voltage range, $V_{ICR}$		-0.1	$V_{CC}+5$	V
Operating free-air temperature, $T_A$	C-suffix	0	70	$^\circ\text{C}$
	I-suffix	-40	125	

**TLV2401, TLV2402, TLV2404**  
**FAMILY OF 880-nA/Ch RAIL-TO-RAIL INPUT/OUTPUT**  
**OPERATIONAL AMPLIFIERS WITH REVERSE BATTERY PROTECTION**

SLOS244B – FEBRUARY 2000 – REVISED NOVEMBER 2000

**electrical characteristics at recommended operating conditions,  $V_{CC} = 2.7, 5 \text{ V}$ , and  $15 \text{ V}$  (unless otherwise noted)**

**dc performance**

PARAMETER		TEST CONDITIONS	$T_A^\dagger$	MIN	TYP	MAX	UNIT
$V_{IO}$	Input offset voltage	$V_O = V_{CC}/2 \text{ V}$ , $V_{IC} = V_{CC}/2 \text{ V}$ , $R_S = 50 \Omega$	25°C	390	1200		$\mu\text{V}$
			Full range		1500		
$\alpha V_{IO}$	Offset voltage draft		25°C	3			$\mu\text{V}/^\circ\text{C}$
CMRR	Common-mode rejection ratio	$V_{IC} = 0 \text{ to } V_{CC}$ , $R_S = 50 \Omega$	$V_{CC} = 2.7 \text{ V}$	25°C	63	120	dB
				Full range	60		
			$V_{CC} = 5 \text{ V}$	25°C	70	120	
				Full range	63		
			$V_{CC} = 15 \text{ V}$	25°C	80	120	
				Full range	75		
AVD	Large-signal differential voltage amplification	$V_{CC} = 2.7 \text{ V}$ , $V_{O(pp)} = 1 \text{ V}$ , $R_L = 500 \text{ k}\Omega$	25°C	130	400	V/mV	
			Full range	30			
			$V_{CC} = 5 \text{ V}$ , $V_{O(pp)} = 3 \text{ V}$ , $R_L = 500 \text{ k}\Omega$	25°C	300		1000
				Full range	100		
			$V_{CC} = 15 \text{ V}$ , $V_{O(pp)} = 6 \text{ V}$ , $R_L = 500 \text{ k}\Omega$	25°C	1000		1800
				Full range	120		

$^\dagger$  Full range is 0°C to 70°C for the C suffix and -40°C to 125°C for the I suffix. If not specified, full range is -40°C to 125°C.

**input characteristics**

PARAMETER		TEST CONDITIONS	$T_A^\dagger$	MIN	TYP	MAX	UNIT	
$I_{IO}$	Input offset current	$V_O = V_{CC}/2 \text{ V}$ , $V_{IC} = V_{CC}/2 \text{ V}$ , $R_S = 50 \Omega$	25°C	25	250		pA	
			Full range	TLV240xC		300		
				TLV240xI		400		
$I_{IB}$	Input bias current	$V_O = V_{CC}/2 \text{ V}$ , $V_{IC} = V_{CC}/2 \text{ V}$ , $R_S = 50 \Omega$	25°C	100	300		pA	
			Full range	TLV240xC		350		
				TLV240xI		900		
$r_{i(d)}$	Differential input resistance		25°C	300			$\text{M}\Omega$	
$C_{i(c)}$	Common-mode input capacitance	$f = 100 \text{ kHz}$	25°C	3			pF	

$^\dagger$  Full range is 0°C to 70°C for the C suffix and -40°C to 125°C for the I suffix. If not specified, full range is -40°C to 125°C.



TLV2401, TLV2402, TLV2404  
**FAMILY OF 880-nA/Ch RAIL-TO-RAIL INPUT/OUTPUT  
 OPERATIONAL AMPLIFIERS WITH REVERSE BATTERY PROTECTION**

SLOS244B – FEBRUARY 2000 – REVISED NOVEMBER 2000

electrical characteristics at recommended operating conditions,  $V_{CC} = 2.7, 5 \text{ V}$ , and  $15 \text{ V}$  (unless otherwise noted) (continued)

**output characteristics**

PARAMETER	TEST CONDITIONS	$T_A$ †	MIN	TYP	MAX	UNIT
$V_{OH}$ High-level output voltage	$V_{IC} = V_{CC}/2$ , $I_{OH} = -2 \mu\text{A}$	$V_{CC} = 2.7 \text{ V}$	25°C	2.65	2.68	V
			Full range	2.63		
		$V_{CC} = 5 \text{ V}$	25°C	4.95	4.98	
			Full range	4.93		
		$V_{CC} = 15 \text{ V}$	25°C	14.95	14.98	
			Full range	14.93		
	$V_{IC} = V_{CC}/2$ , $I_{OH} = -50 \mu\text{A}$	$V_{CC} = 2.7 \text{ V}$	25°C	2.62	2.65	
			Full range	2.6		
		$V_{CC} = 5 \text{ V}$	25°C	4.92	4.95	
			Full range	4.9		
		$V_{CC} = 15 \text{ V}$	25°C	14.92	14.95	
			Full range	14.9		
$V_{OL}$ Low-level output voltage	$V_{IC} = V_{CC}/2$ , $I_{OL} = 2 \mu\text{A}$	25°C		90	150	mV
		Full range			180	
	$V_{IC} = V_{CC}/2$ , $I_{OL} = 50 \mu\text{A}$	25°C		180	230	
		Full range			260	
$I_O$ Output current	$V_O = 0.5 \text{ V}$ from rail	25°C		±200		μA

† Full range is 0°C to 70°C for the C suffix and -40°C to 125°C for the I suffix. If not specified, full range is -40°C to 125°C.

**power supply**

PARAMETER	TEST CONDITIONS	$T_A$ †	MIN	TYP	MAX	UNIT
$I_{CC}$ Supply current (per channel)	$V_O = V_{CC}/2$	$V_{CC} = 2.7 \text{ V}$ or $5 \text{ V}$	25°C	880	950	nA
			Full range		1290	
		$V_{CC} = 15 \text{ V}$	25°C	900	990	
			Full range		1350	
Reverse supply current	$V_{CC} = -18 \text{ V}$ , $V_{IN} = 0 \text{ V}$ , $V_O = \text{Open circuit}$	25°C		50		nA
PSRR Power supply rejection ratio ( $\Delta V_{CC}/\Delta V_{IO}$ )	$V_{CC} = 2.7$ to $5 \text{ V}$ , $V_{IC} = V_{CC}/2 \text{ V}$ , No load,	TLV240xC	25°C	100	120	dB
			Full range	96		
		TLV240xI	25°C	85		dB
			Full range	85		
	$V_{CC} = 5$ to $15 \text{ V}$ , $V_{IC} = V_{CC}/2 \text{ V}$ , No load	25°C	100	120	dB	
		Full range	100			

† Full range is 0°C to 70°C for the C suffix and -40°C to 125°C for the I suffix. If not specified, full range is -40°C to 125°C.



**TLV2401, TLV2402, TLV2404**  
**FAMILY OF 880-nA/Ch RAIL-TO-RAIL INPUT/OUTPUT**  
**OPERATIONAL AMPLIFIERS WITH REVERSE BATTERY PROTECTION**

SLOS244B – FEBRUARY 2000 – REVISED NOVEMBER 2000

**electrical characteristics at recommended operating conditions,  $V_{CC} = 2.7, 5 \text{ V}$ , and  $15 \text{ V}$  (unless otherwise noted) (continued)**

**dynamic performance**

PARAMETER		TEST CONDITIONS		$T_A$	MIN	TYP	MAX	UNIT
UGBW	Unity gain bandwidth	$R_L = 500 \text{ k}\Omega$ ,	$C_L = 100 \text{ pF}$	$25^\circ\text{C}$		5.5		kHz
SR	Slew rate at unity gain	$V_{O(pp)} = 0.8 \text{ V}$ ,	$R_L = 500 \text{ k}\Omega$ , $C_L = 100 \text{ pF}$	$25^\circ\text{C}$		2.5		V/ms
$\phi M$	Phase margin	$R_L = 500 \text{ k}\Omega$ , $C_L = 100 \text{ pF}$		$25^\circ\text{C}$				60°
	Gain margin							15
$t_s$	Settling time	$V_{CC} = 2.7 \text{ or } 5 \text{ V}$ , $V(\text{STEP})_{PP} = 1 \text{ V}$ , $C_L = 100 \text{ pF}$ , $A_V = -1$ , $R_L = 100 \text{ k}\Omega$		$25^\circ\text{C}$				0.1%
		$V_{CC} = 15 \text{ V}$ , $V(\text{STEP})_{PP} = 1 \text{ V}$ , $C_L = 100 \text{ pF}$ , $A_V = -1$ , $R_L = 100 \text{ k}\Omega$						0.1%
		$V_{CC} = 15 \text{ V}$ , $V(\text{STEP})_{PP} = 1 \text{ V}$ , $C_L = 100 \text{ pF}$ , $A_V = -1$ , $R_L = 100 \text{ k}\Omega$						0.01%
						1.84		ms
						6.1		
						32		

**noise/distortion performance**

PARAMETER		TEST CONDITIONS	$T_A$	MIN	TYP	MAX	UNIT
$V_n$	Equivalent input noise voltage	$f = 10 \text{ Hz}$	$25^\circ\text{C}$				800
		$f = 100 \text{ Hz}$					500
$I_n$	Equivalent input noise current	$f = 100 \text{ Hz}$					8



TLV2401, TLV2402, TLV2404  
**FAMILY OF 880-nA/Ch RAIL-TO-RAIL INPUT/OUTPUT  
 OPERATIONAL AMPLIFIERS WITH REVERSE BATTERY PROTECTION**  
 SLOS244B – FEBRUARY 2000 – REVISED NOVEMBER 2000

**TYPICAL CHARACTERISTICS**

**Table of Graphs**

			<b>FIGURE</b>
$V_{IO}$	Input Offset Voltage	vs Common-mode input voltage	1, 2, 3
$I_{IB}$	Input Bias Current	vs Free-air temperature	4, 6, 8
		vs Common-mode input voltage	5, 7, 9
$I_{IO}$	Input Offset Current	vs Free-air temperature	4, 6, 8
		vs Common-mode input voltage	5, 7, 9
CMRR	Common-mode rejection ratio	vs Frequency	10
$V_{OH}$	High-level output voltage	vs High-level output current	11, 13, 15
$V_{OL}$	Low-level output voltage	vs Low-level output current	12, 14, 16
$V_{O(PP)}$	Output voltage peak-to-peak	vs Frequency	17
$Z_o$	Output impedance	vs Frequency	18
$I_{CC}$	Supply current	vs Supply voltage	19
PSRR	Power supply rejection ratio	vs Frequency	20
$A_{VD}$	Differential voltage gain	vs Frequency	21
	Phase	vs Frequency	21
	Gain-bandwidth product	vs Supply voltage	22
SR	Slew rate	vs Free-air temperature	23
$\phi_m$	Phase margin	vs Capacitive load	24
	Gain margin	vs Capacitive load	25
	Supply current	vs Reverse voltage	26
	Voltage noise over a 10 Second Period		27
	Large signal follower pulse response		28, 29, 30
	Small signal follower pulse response		31
	Large signal inverting pulse response		32, 33, 34
	Small signal inverting pulse response		35
	Crosstalk	vs Frequency	36

# TLV2401, TLV2402, TLV2404

## FAMILY OF 880-nA/Ch RAIL-TO-RAIL INPUT/OUTPUT

### OPERATIONAL AMPLIFIERS WITH REVERSE BATTERY PROTECTION

SLOS244B – FEBRUARY 2000 – REVISED NOVEMBER 2000

#### TYPICAL CHARACTERISTICS

**INPUT OFFSET VOLTAGE**  
vs  
**COMMON-MODE INPUT VOLTAGE**

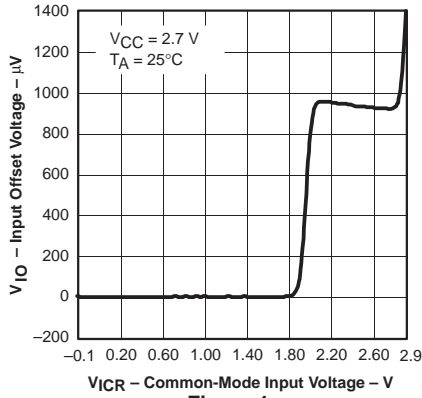

Figure 1

**INPUT OFFSET VOLTAGE**  
vs  
**COMMON-MODE INPUT VOLTAGE**

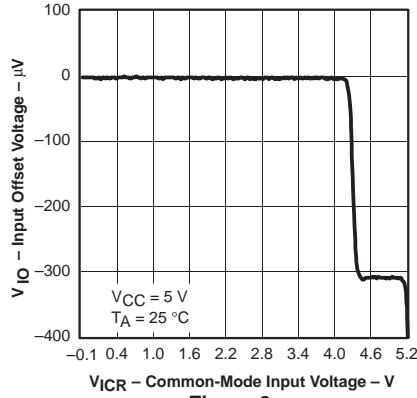

Figure 2

**INPUT OFFSET VOLTAGE**  
vs  
**COMMON-MODE INPUT VOLTAGE**

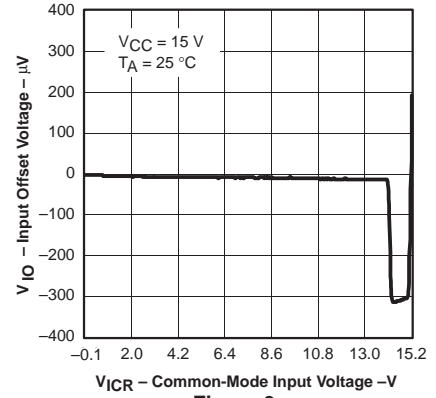

Figure 3

**INPUT BIAS / OFFSET CURRENT**  
vs  
**FREE-AIR TEMPERATURE**

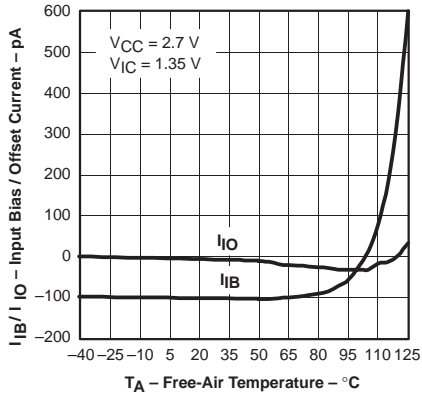

Figure 4

**INPUT BIAS / OFFSET CURRENT**  
vs  
**COMMON MODE INPUT VOLTAGE**

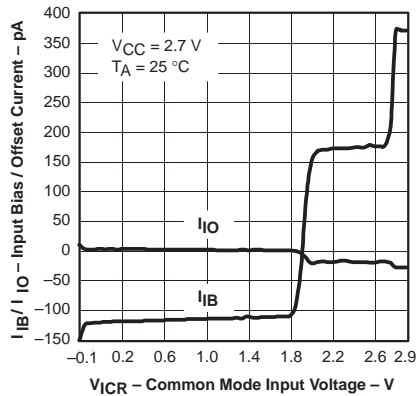

Figure 5

**INPUT BIAS / OFFSET CURRENT**  
vs  
**FREE-AIR TEMPERATURE**

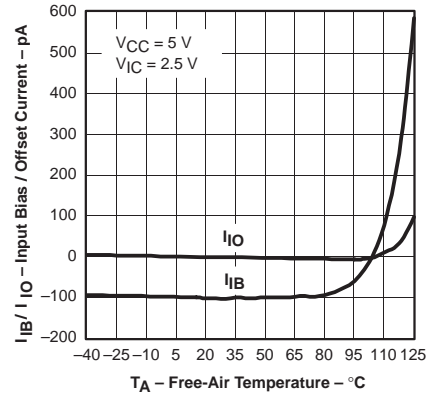

Figure 6

**INPUT BIAS / OFFSET CURRENT**  
vs  
**COMMON-MODE INPUT VOLTAGE**

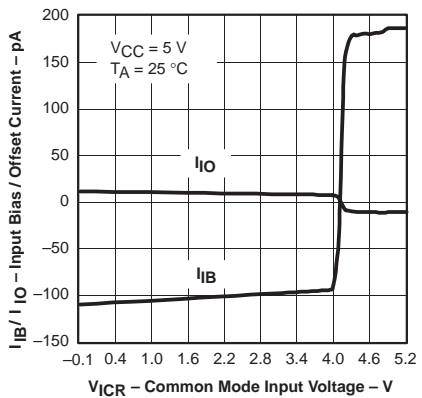

Figure 7

**INPUT BIAS / OFFSET CURRENT**  
vs  
**FREE-AIR TEMPERATURE**

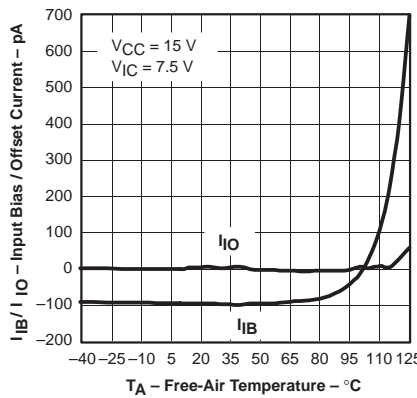

Figure 8

**INPUT BIAS / OFFSET CURRENT**  
vs  
**COMMON-MODE INPUT VOLTAGE**

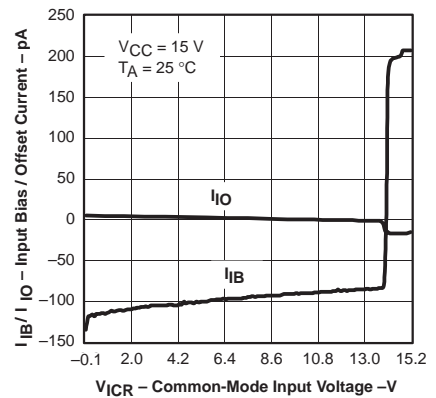

Figure 9





**TYPICAL CHARACTERISTICS**

**COMMON-MODE REJECTION RATIO  
 vs  
 FREQUENCY**

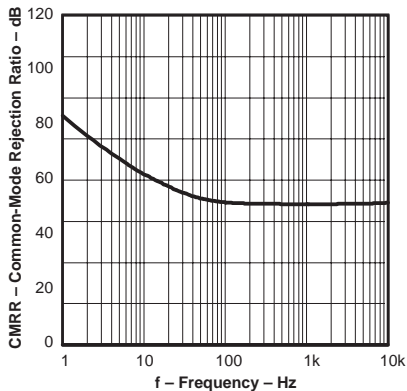

Figure 10

**HIGH-LEVEL OUTPUT VOLTAGE  
 vs  
 HIGH-LEVEL OUTPUT CURRENT**

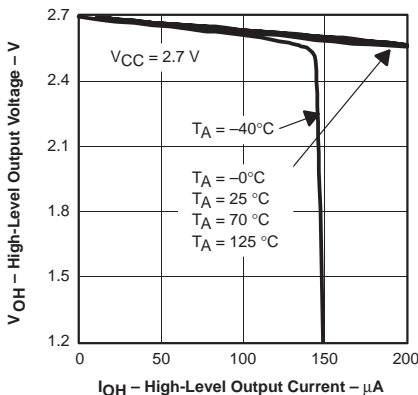

Figure 11

**LOW-LEVEL OUTPUT VOLTAGE  
 vs  
 LOW-LEVEL OUTPUT CURRENT**

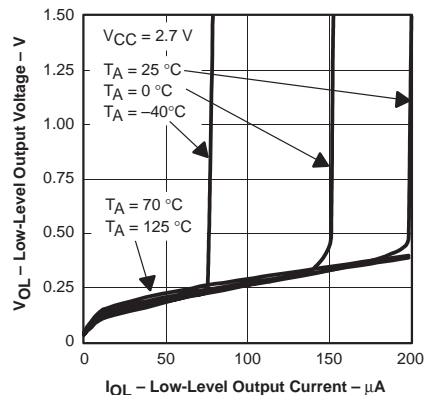

Figure 12

**HIGH-LEVEL OUTPUT VOLTAGE  
 vs  
 HIGH-LEVEL OUTPUT CURRENT**

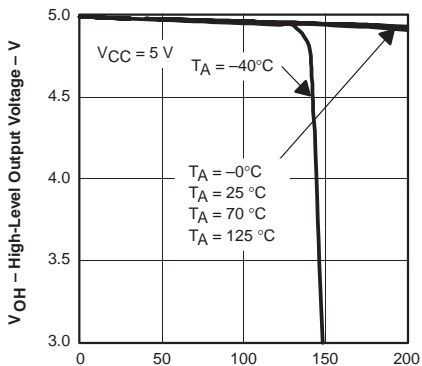

Figure 13

**LOW-LEVEL OUTPUT VOLTAGE  
 vs  
 LOW-LEVEL OUTPUT CURRENT**

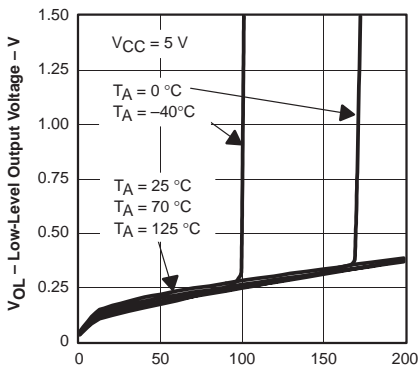

Figure 14

**HIGH-LEVEL OUTPUT VOLTAGE  
 vs  
 HIGH-LEVEL OUTPUT CURRENT**

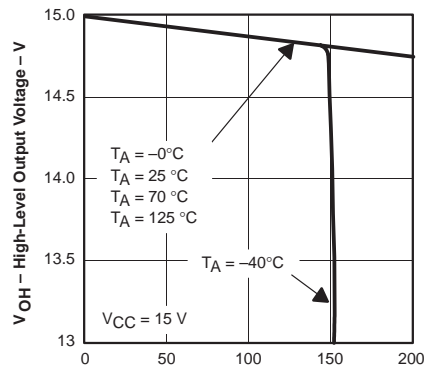

Figure 15

**LOW-LEVEL OUTPUT VOLTAGE  
 vs  
 LOW-LEVEL OUTPUT CURRENT**

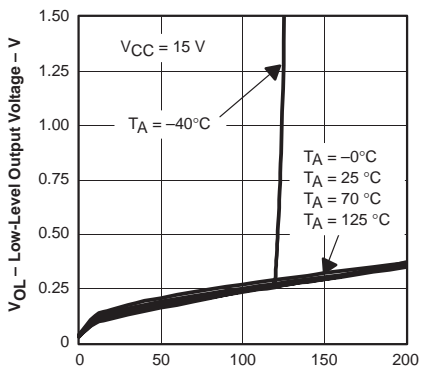

Figure 16

**OUTPUT VOLTAGE  
 PEAK-TO-PEAK  
 vs  
 FREQUENCY**

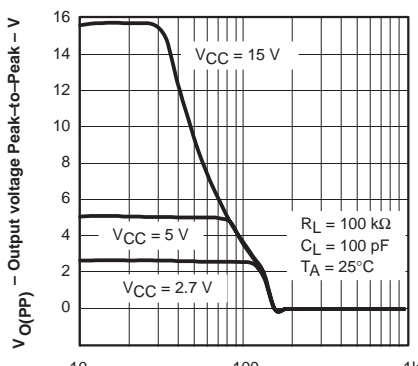

Figure 17

**OUTPUT IMPEDANCE  
 vs  
 FREQUENCY**

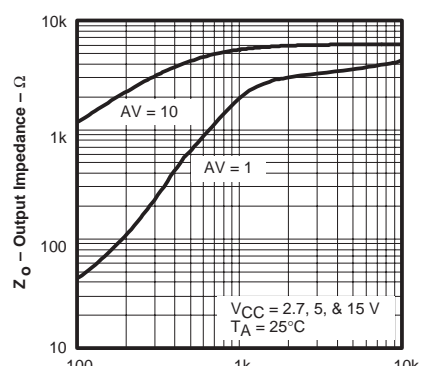

Figure 18

# TLV2401, TLV2402, TLV2404

## FAMILY OF 880-nA/Ch RAIL-TO-RAIL INPUT/OUTPUT

### OPERATIONAL AMPLIFIERS WITH REVERSE BATTERY PROTECTION

SLOS244B – FEBRUARY 2000 – REVISED NOVEMBER 2000

#### TYPICAL CHARACTERISTICS

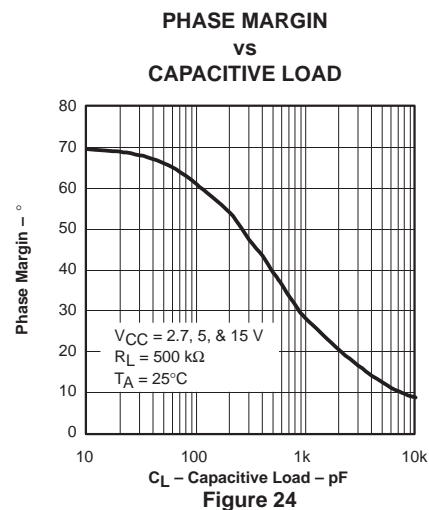
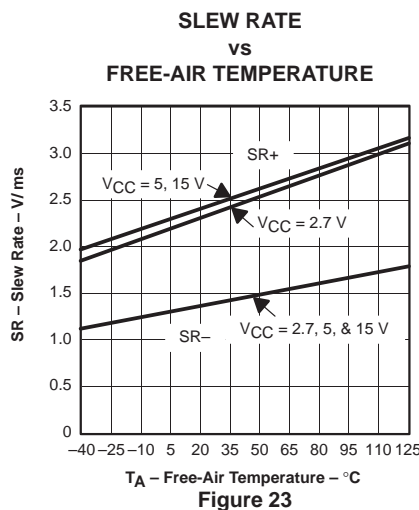
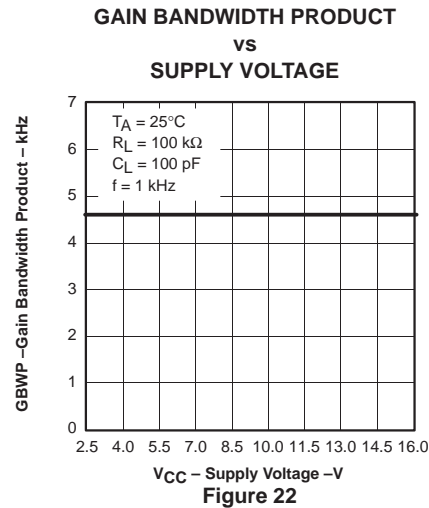
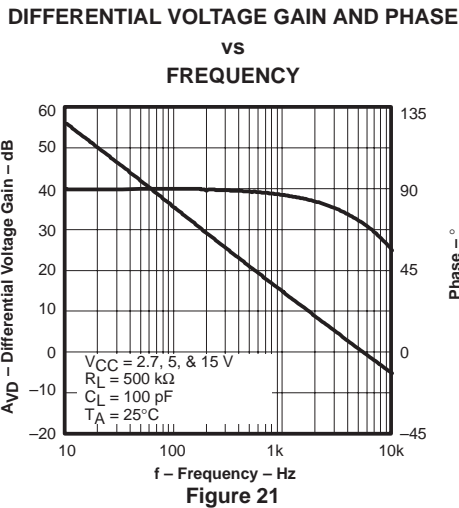
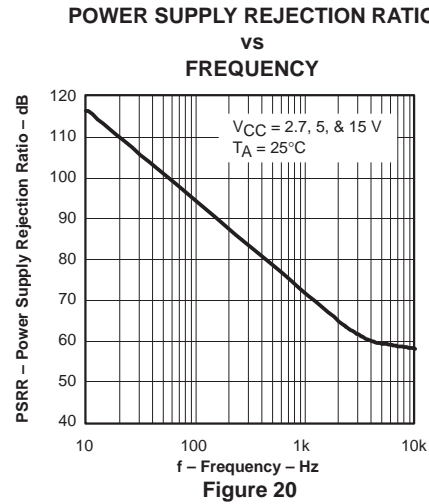
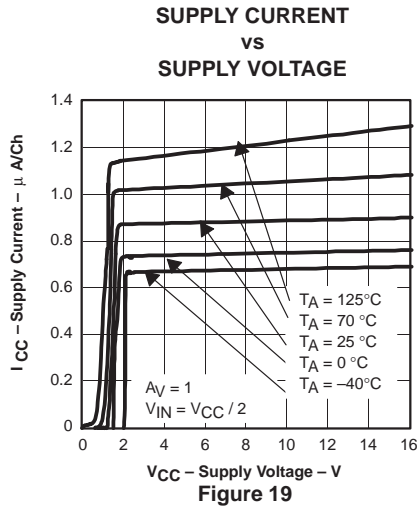

**TLV2401, TLV2402, TLV2404**  
**FAMILY OF 880-nA/Ch RAIL-TO-RAIL INPUT/OUTPUT**  
**OPERATIONAL AMPLIFIERS WITH REVERSE BATTERY PROTECTION**

SLOS244B – FEBRUARY 2000 – REVISED NOVEMBER 2000

**TYPICAL CHARACTERISTICS**

**GAIN MARGIN  
VS  
CAPACITIVE LOAD**

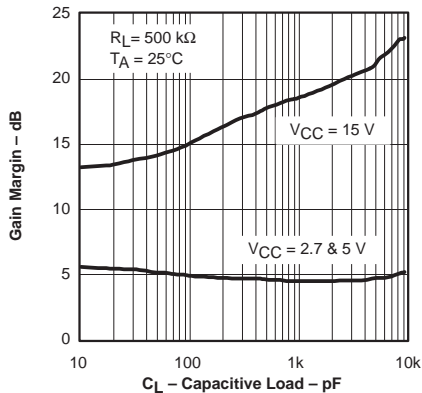

Figure 25

**SUPPLY CURRENT  
VS  
REVERSE VOLTAGE**

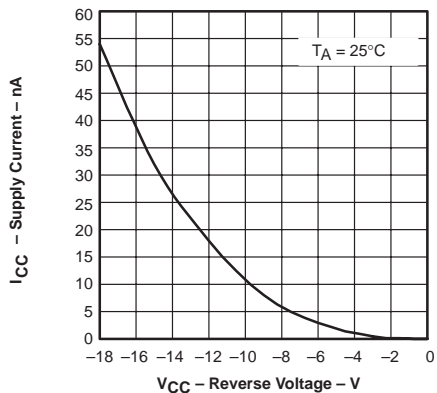

Figure 26

**VOLTAGE NOISE  
OVER A 10 SECOND PERIOD**

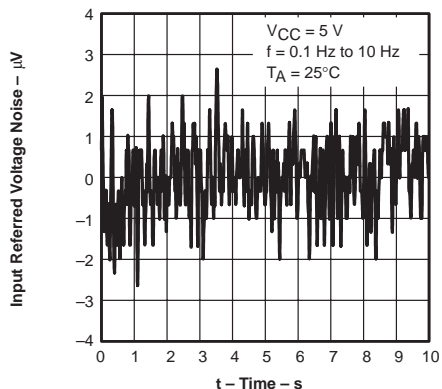

Figure 27

**LARGE SIGNAL FOLLOWER  
PULSE RESPONSE**

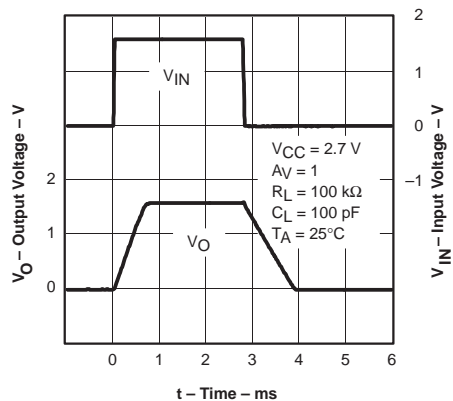

Figure 28

**LARGE SIGNAL FOLLOWER  
PULSE RESPONSE**

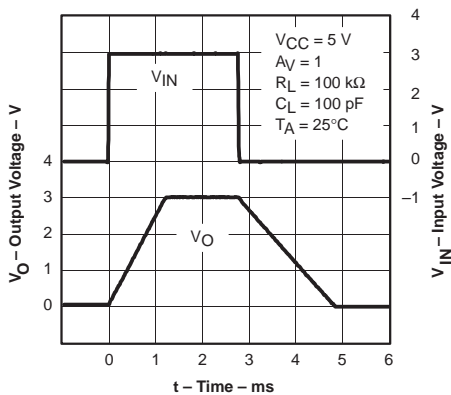

Figure 29

**LARGE SIGNAL FOLLOWER  
PULSE RESPONSE**

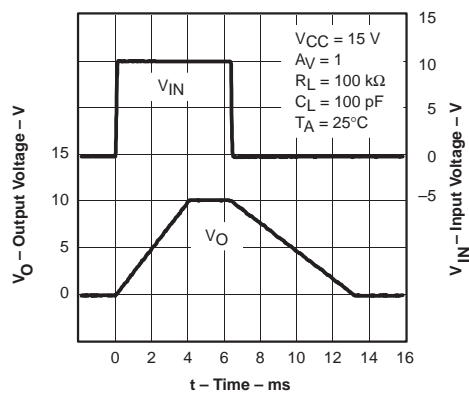

Figure 30

# TLV2401, TLV2402, TLV2404

## FAMILY OF 880-nA/Ch RAIL-TO-RAIL INPUT/OUTPUT

### OPERATIONAL AMPLIFIERS WITH REVERSE BATTERY PROTECTION

SLOS244B – FEBRUARY 2000 – REVISED NOVEMBER 2000

#### TYPICAL CHARACTERISTICS

**SMALL SIGNAL FOLLOWER PULSE RESPONSE**

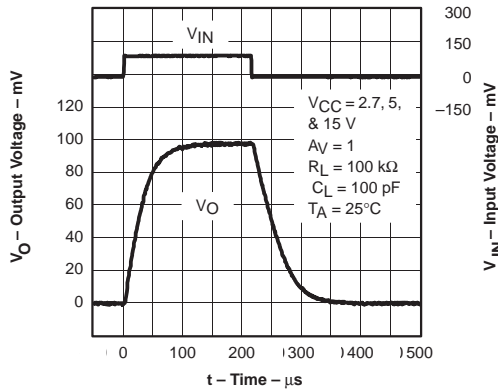

Figure 31

**LARGE SIGNAL INVERTING PULSE RESPONSE**

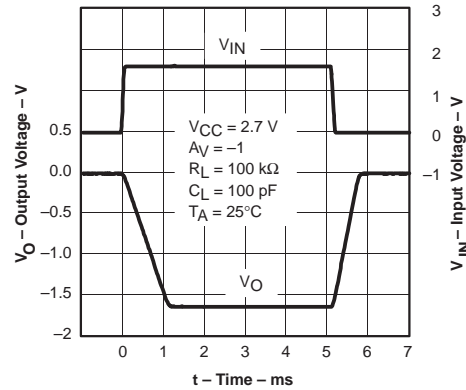

Figure 32

**LARGE SIGNAL INVERTING PULSE RESPONSE**

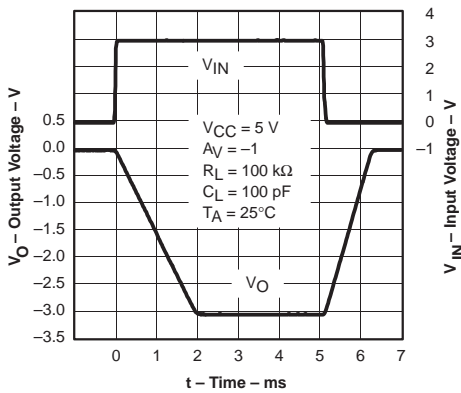

Figure 33

**LARGE SIGNAL INVERTING PULSE RESPONSE**

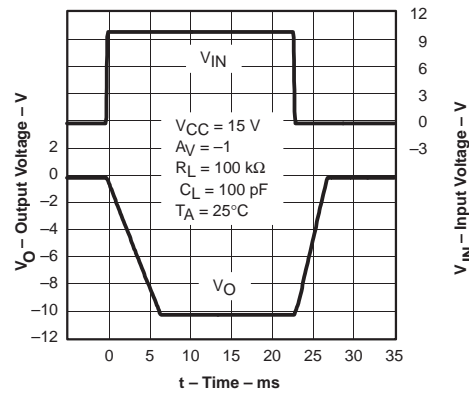

Figure 34

**SMALL SIGNAL INVERTING PULSE RESPONSE**

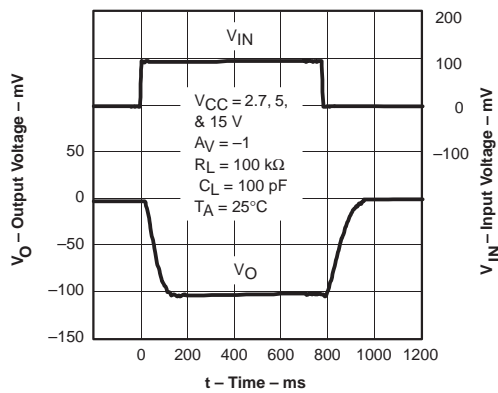

Figure 35

**CROSSTALK vs FREQUENCY**

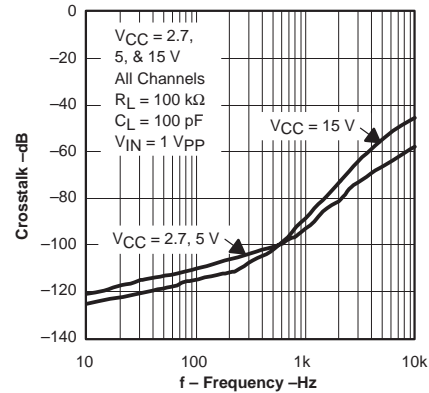

Figure 36

## APPLICATION INFORMATION

### reverse battery protection

The TLV2401/2/4 are protected against reverse battery voltage up to 18 V. When subjected to reverse battery condition the supply current is typically less than 100 nA at 25°C (inputs grounded and outputs open). This current is determined by the leakage of 6 Schottky diodes and will therefore increase as the ambient temperature increases.

When subjected to reverse battery conditions and negative voltages applied to the inputs or outputs, the input ESD structure will turn on—this current should be limited to less than 10 mA. If the inputs or outputs are referred to ground, rather than midrail, no extra precautions need be taken.

### common-mode input range

The TLV2401/2/4 has rail-to-rail input and outputs. For common-mode inputs from  $-0.1\text{ V}$  to  $V_{CC} - 0.8\text{ V}$  a PNP differential pair will provide the gain.

For inputs between  $V_{CC} - 0.8\text{ V}$  and  $V_{CC}$ , two NPN emitter followers buffering a second PNP differential pair provide the gain. This special combination of NPN/PNP differential pair enables the inputs to be taken 5 V above the rails, because as the inputs go above  $V_{CC}$ , the NPNs switch from functioning as transistors to functioning as diodes. This will lead to an increase in input bias current. The second PNP differential pair continues to function normally as the inputs exceed  $V_{CC}$ .

The TLV2401/2/4 has a negative common-input range that exceeds ground by 100 mV. If the inputs are taken much below this, reduced open loop gain will be observed with the ultimate possibility of phase inversion.

### offset voltage

The output offset voltage, ( $V_{OO}$ ) is the sum of the input offset voltage ( $V_{IO}$ ) and both input bias currents ( $I_{IB}$ ) times the corresponding gains. The following schematic and formula can be used to calculate the output offset voltage:

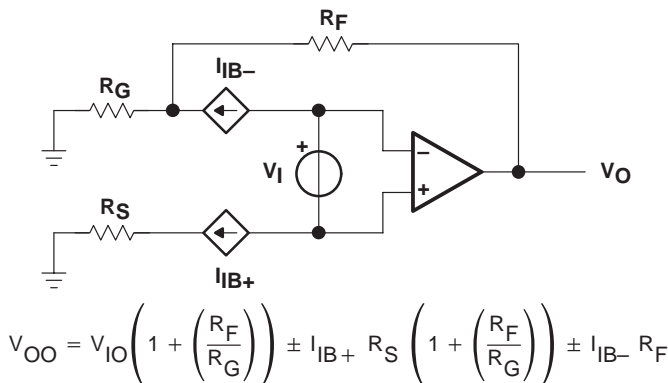

**Figure 37. Output Offset Voltage Model**

APPLICATION INFORMATION

general configurations

When receiving low-level signals, limiting the bandwidth of the incoming signals into the system is often required. The simplest way to accomplish this is to place an RC filter at the noninverting terminal of the amplifier (see Figure 38).

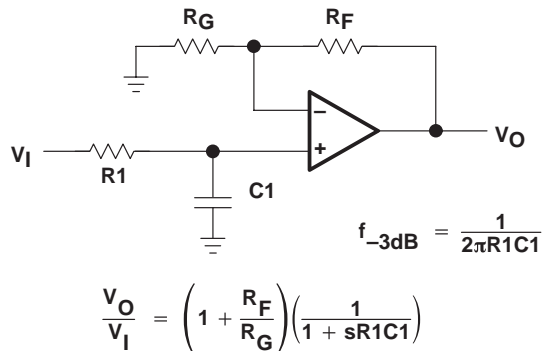

Figure 38. Single-Pole Low-Pass Filter

If even more attenuation is needed, a multiple pole filter is required. The Sallen-Key filter can be used for this task. For best results, the amplifier should have a bandwidth that is 8 to 10 times the filter frequency bandwidth. Failure to do this can result in phase shift of the amplifier.

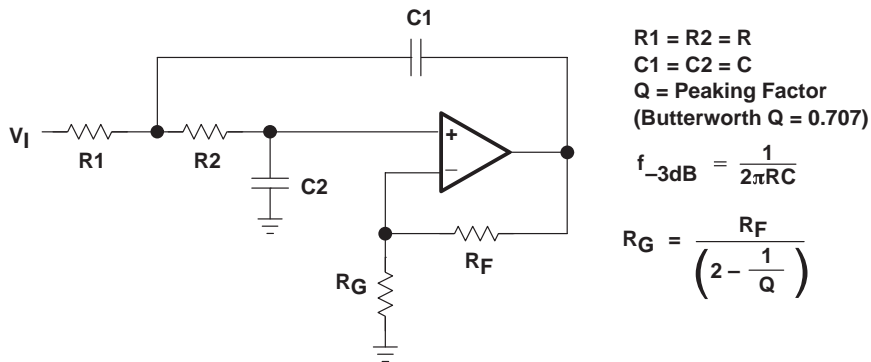

Figure 39. 2-Pole Low-Pass Sallen-Key Filter

## APPLICATION INFORMATION

### circuit layout considerations

To achieve the levels of high performance of the TLV240x, follow proper printed-circuit board design techniques. A general set of guidelines is given in the following.

- Ground planes – It is highly recommended that a ground plane be used on the board to provide all components with a low inductive ground connection. However, in the areas of the amplifier inputs and output, the ground plane can be removed to minimize the stray capacitance.
- Proper power supply decoupling – Use a 6.8- $\mu$ F tantalum capacitor in parallel with a 0.1- $\mu$ F ceramic capacitor on each supply terminal. It may be possible to share the tantalum among several amplifiers depending on the application, but a 0.1- $\mu$ F ceramic capacitor should always be used on the supply terminal of every amplifier. In addition, the 0.1- $\mu$ F capacitor should be placed as close as possible to the supply terminal. As this distance increases, the inductance in the connecting trace makes the capacitor less effective. The designer should strive for distances of less than 0.1 inches between the device power terminals and the ceramic capacitors.
- Sockets – Sockets can be used but are not recommended. The additional lead inductance in the socket pins will often lead to stability problems. Surface-mount packages soldered directly to the printed-circuit board is the best implementation.
- Short trace runs/compact part placements – Optimum high performance is achieved when stray series inductance has been minimized. To realize this, the circuit layout should be made as compact as possible, thereby minimizing the length of all trace runs. Particular attention should be paid to the inverting input of the amplifier. Its length should be kept as short as possible. This will help to minimize stray capacitance at the input of the amplifier.
- Surface-mount passive components – Using surface-mount passive components is recommended for high performance amplifier circuits for several reasons. First, because of the extremely low lead inductance of surface-mount components, the problem with stray series inductance is greatly reduced. Second, the small size of surface-mount components naturally leads to a more compact layout thereby minimizing both stray inductance and capacitance. If leaded components are used, it is recommended that the lead lengths be kept as short as possible.

**TLV2401, TLV2402, TLV2404**  
**FAMILY OF 880-nA/Ch RAIL-TO-RAIL INPUT/OUTPUT**  
**OPERATIONAL AMPLIFIERS WITH REVERSE BATTERY PROTECTION**

SLOS244B – FEBRUARY 2000 – REVISED NOVEMBER 2000

**APPLICATION INFORMATION**

**general power dissipation considerations**

For a given  $\theta_{JA}$ , the maximum power dissipation is shown in Figure 40 and is calculated by the following formula:

$$P_D = \left( \frac{T_{MAX} - T_A}{\theta_{JA}} \right)$$

Where:

- $P_D$  = Maximum power dissipation of THS240x IC (watts)
- $T_{MAX}$  = Absolute maximum junction temperature (150°C)
- $T_A$  = Free-ambient air temperature (°C)
- $\theta_{JA}$  =  $\theta_{JC} + \theta_{CA}$
- $\theta_{JC}$  = Thermal coefficient from junction to case
- $\theta_{CA}$  = Thermal coefficient from case to ambient air (°C/W)

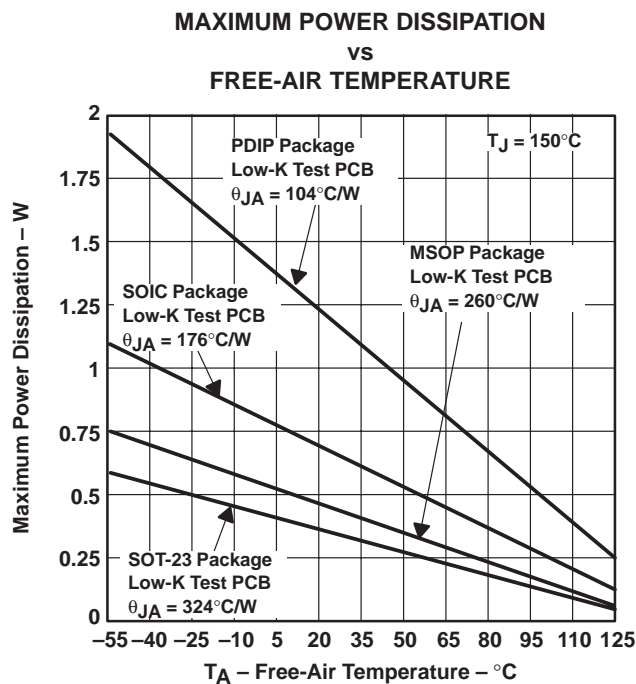

NOTE A: Results are with no air flow and using JEDEC Standard Low-K test PCB.

**Figure 40. Maximum Power Dissipation vs Free-Air Temperature**





# TLV2401, TLV2402, TLV2404 FAMILY OF 880-nA/Ch RAIL-TO-RAIL INPUT/OUTPUT OPERATIONAL AMPLIFIERS WITH REVERSE BATTERY PROTECTION

SLOS244B – FEBRUARY 2000 – REVISED NOVEMBER 2000

## APPLICATION INFORMATION

### macromodel information

Macromodel information provided was derived using Microsim *Parts*™ Release 8, the model generation software used with Microsim *PSpice*™. The Boyle macromodel (see Note 2) and subcircuit in Figure 41 are generated using the TLV240x typical electrical and operating characteristics at  $T_A = 25^\circ\text{C}$ . Using this information, output simulations of the following key parameters can be generated to a tolerance of 20% (in most cases):

- Maximum positive output voltage swing
- Maximum negative output voltage swing
- Slew rate
- Quiescent power dissipation
- Input bias current
- Open-loop voltage amplification
- Unity-gain frequency
- Common-mode rejection ratio
- Phase margin
- DC output resistance
- AC output resistance
- Short-circuit output current limit

NOTE 2: G. R. Boyle, B. M. Cohn, D. O. Pederson, and J. E. Solomon, "Macromodeling of Integrated Circuit Operational Amplifiers", *IEEE Journal of Solid-State Circuits*, SC-9, 353 (1974).

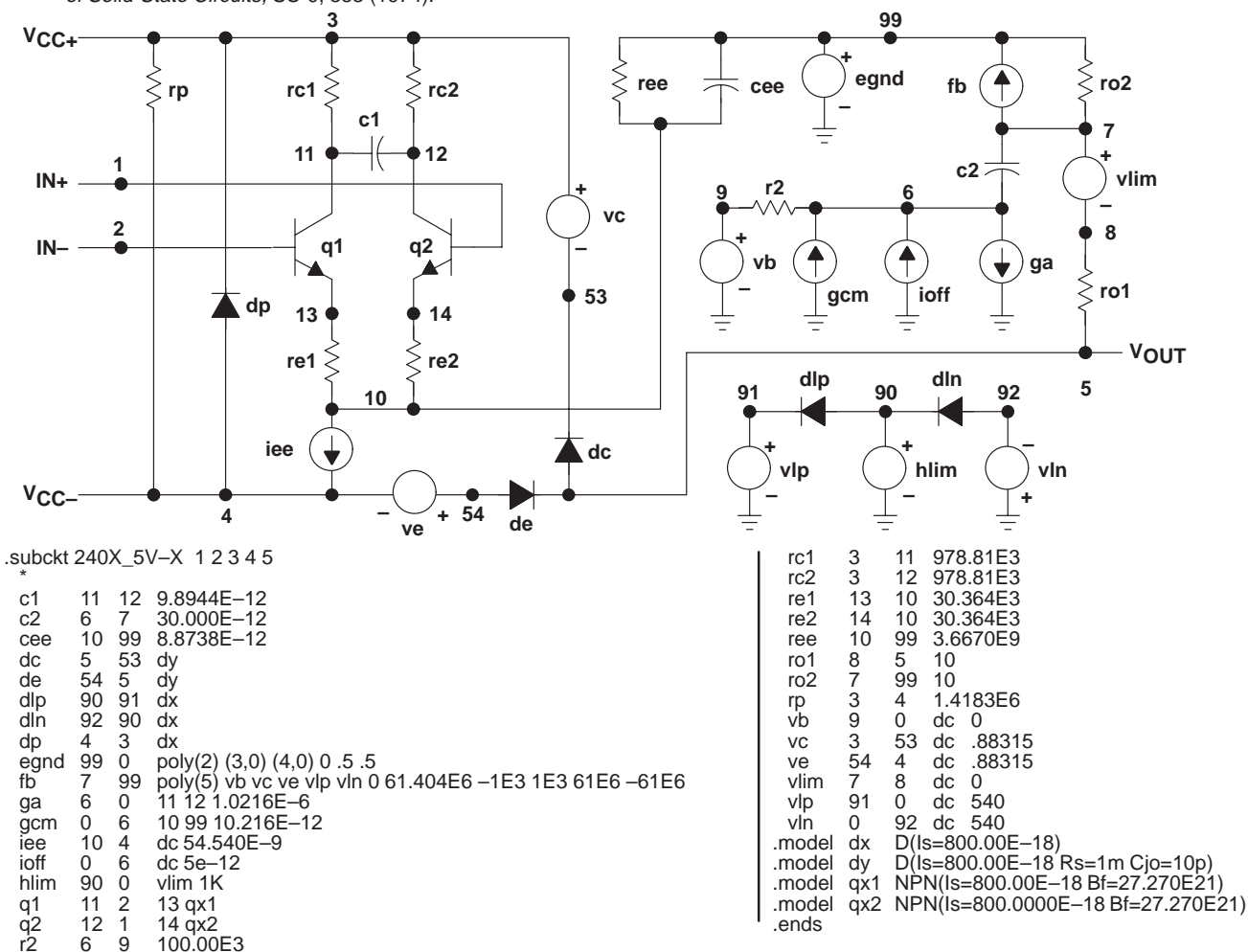

**Figure 41. Boyle Macromodels and Subcircuit**

*PSpice* and *Parts* are trademarks of MicroSim Corporation.



**PACKAGING INFORMATION**

Orderable Device	Status (1)	Package Type	Package Drawing	Pins	Package Qty	Eco Plan (2)	Lead finish/ Ball material (6)	MSL Peak Temp (3)	Op Temp (°C)	Device Marking (4/5)	Samples
TLV2401CD	LIFEBUY	SOIC	D	8	75	RoHS & Green	NIPDAU	Level-1-260C-UNLIM	0 to 70	2401C	
TLV2401CDBVR	ACTIVE	SOT-23	DBV	5	3000	RoHS & Green	NIPDAU	Level-1-260C-UNLIM	0 to 70	VAWC	<a href="#">Samples</a>
TLV2401CDBVT	ACTIVE	SOT-23	DBV	5	250	RoHS & Green	NIPDAU	Level-1-260C-UNLIM	0 to 70	VAWC	<a href="#">Samples</a>
TLV2401CDR	ACTIVE	SOIC	D	8	2500	RoHS & Green	NIPDAU	Level-1-260C-UNLIM	0 to 70	2401C	<a href="#">Samples</a>
TLV2401ID	ACTIVE	SOIC	D	8	75	RoHS & Green	NIPDAU	Level-1-260C-UNLIM	-40 to 125	2401I	<a href="#">Samples</a>
TLV2401IDBVR	ACTIVE	SOT-23	DBV	5	3000	RoHS & Green	NIPDAU	Level-1-260C-UNLIM	-40 to 125	VAWI	<a href="#">Samples</a>
TLV2401IDBVT	ACTIVE	SOT-23	DBV	5	250	RoHS & Green	NIPDAU	Level-1-260C-UNLIM	-40 to 125	VAWI	<a href="#">Samples</a>
TLV2401IDBVTG4	ACTIVE	SOT-23	DBV	5	250	TBD	Call TI	Call TI	-40 to 125		<a href="#">Samples</a>
TLV2401IDR	ACTIVE	SOIC	D	8	2500	RoHS & Green	NIPDAU	Level-1-260C-UNLIM	-40 to 125	2401I	<a href="#">Samples</a>
TLV2401IP	ACTIVE	PDIP	P	8	50	RoHS & Green	NIPDAU	N / A for Pkg Type	-40 to 125	TLV2401I	<a href="#">Samples</a>
TLV2402CD	ACTIVE	SOIC	D	8	75	RoHS & Green	NIPDAU	Level-1-260C-UNLIM	0 to 70	2402C	<a href="#">Samples</a>
TLV2402CDGK	ACTIVE	VSSOP	DGK	8	80	RoHS & Green	NIPDAU	Level-1-260C-UNLIM	0 to 70	AIX	<a href="#">Samples</a>
TLV2402CDGKR	ACTIVE	VSSOP	DGK	8	2500	RoHS & Green	NIPDAU	Level-1-260C-UNLIM	0 to 70	AIX	<a href="#">Samples</a>
TLV2402CDR	ACTIVE	SOIC	D	8	2500	RoHS & Green	NIPDAU	Level-1-260C-UNLIM	0 to 70	2402C	<a href="#">Samples</a>
TLV2402ID	ACTIVE	SOIC	D	8	75	RoHS & Green	NIPDAU	Level-1-260C-UNLIM	-40 to 125	2402I	<a href="#">Samples</a>
TLV2402IDG4	LIFEBUY	SOIC	D	8	75	RoHS & Green	NIPDAU	Level-1-260C-UNLIM	-40 to 125	2402I	
TLV2402IDGK	ACTIVE	VSSOP	DGK	8	80	RoHS & Green	NIPDAU	Level-1-260C-UNLIM	-40 to 125	AIY	<a href="#">Samples</a>
TLV2402IDGKR	ACTIVE	VSSOP	DGK	8	2500	RoHS & Green	NIPDAU	Level-1-260C-UNLIM	-40 to 125	AIY	<a href="#">Samples</a>
TLV2402IDR	ACTIVE	SOIC	D	8	2500	RoHS & Green	NIPDAU	Level-1-260C-UNLIM	-40 to 125	2402I	<a href="#">Samples</a>
TLV2402IDRG4	LIFEBUY	SOIC	D	8	2500	RoHS & Green	NIPDAU	Level-1-260C-UNLIM	-40 to 125	2402I	
TLV2402IP	ACTIVE	PDIP	P	8	50	RoHS & Green	NIPDAU	N / A for Pkg Type	-40 to 125	TLV2402I	<a href="#">Samples</a>

Orderable Device	Status (1)	Package Type	Package Drawing	Pins	Package Qty	Eco Plan (2)	Lead finish/ Ball material (6)	MSL Peak Temp (3)	Op Temp (°C)	Device Marking (4/5)	Samples
TLV2404CD	ACTIVE	SOIC	D	14	50	RoHS & Green	NIPDAU	Level-1-260C-UNLIM	0 to 70	TLV2404C	<a href="#">Samples</a>
TLV2404CPW	ACTIVE	TSSOP	PW	14	90	RoHS & Green	NIPDAU	Level-1-260C-UNLIM	0 to 70	2404C	<a href="#">Samples</a>
TLV2404CPWR	ACTIVE	TSSOP	PW	14	2000	RoHS & Green	NIPDAU	Level-1-260C-UNLIM	0 to 70	2404C	<a href="#">Samples</a>
TLV2404ID	ACTIVE	SOIC	D	14	50	RoHS & Green	NIPDAU	Level-1-260C-UNLIM	-40 to 125	TLV2404I	<a href="#">Samples</a>
TLV2404IDR	ACTIVE	SOIC	D	14	2500	RoHS & Green	NIPDAU	Level-1-260C-UNLIM	-40 to 125	TLV2404I	<a href="#">Samples</a>
TLV2404IN	ACTIVE	PDIP	N	14	25	RoHS & Green	NIPDAU	N / A for Pkg Type	-40 to 125	TLV2404IN	<a href="#">Samples</a>
TLV2404IPW	ACTIVE	TSSOP	PW	14	90	RoHS & Green	NIPDAU	Level-1-260C-UNLIM	-40 to 125	2404I	<a href="#">Samples</a>
TLV2404IPWR	ACTIVE	TSSOP	PW	14	2000	RoHS & Green	NIPDAU	Level-1-260C-UNLIM	-40 to 125	2404I	<a href="#">Samples</a>

(1) The marketing status values are defined as follows:

**ACTIVE:** Product device recommended for new designs.

**LIFEBUY:** TI has announced that the device will be discontinued, and a lifetime-buy period is in effect.

**NRND:** Not recommended for new designs. Device is in production to support existing customers, but TI does not recommend using this part in a new design.

**PREVIEW:** Device has been announced but is not in production. Samples may or may not be available.

**OBSOLETE:** TI has discontinued the production of the device.

(2) **RoHS:** TI defines "RoHS" to mean semiconductor products that are compliant with the current EU RoHS requirements for all 10 RoHS substances, including the requirement that RoHS substance do not exceed 0.1% by weight in homogeneous materials. Where designed to be soldered at high temperatures, "RoHS" products are suitable for use in specified lead-free processes. TI may reference these types of products as "Pb-Free".

**RoHS Exempt:** TI defines "RoHS Exempt" to mean products that contain lead but are compliant with EU RoHS pursuant to a specific EU RoHS exemption.

**Green:** TI defines "Green" to mean the content of Chlorine (Cl) and Bromine (Br) based flame retardants meet JS709B low halogen requirements of <=1000ppm threshold. Antimony trioxide based flame retardants must also meet the <=1000ppm threshold requirement.

(3) MSL, Peak Temp. - The Moisture Sensitivity Level rating according to the JEDEC industry standard classifications, and peak solder temperature.

(4) There may be additional marking, which relates to the logo, the lot trace code information, or the environmental category on the device.

(5) Multiple Device Markings will be inside parentheses. Only one Device Marking contained in parentheses and separated by a "~" will appear on a device. If a line is indented then it is a continuation of the previous line and the two combined represent the entire Device Marking for that device.

(6) Lead finish/Ball material - Orderable Devices may have multiple material finish options. Finish options are separated by a vertical ruled line. Lead finish/Ball material values may wrap to two lines if the finish value exceeds the maximum column width.

**Important Information and Disclaimer:**The information provided on this page represents TI's knowledge and belief as of the date that it is provided. TI bases its knowledge and belief on information provided by third parties, and makes no representation or warranty as to the accuracy of such information. Efforts are underway to better integrate information from third parties. TI has taken and continues to take reasonable steps to provide representative and accurate information but may not have conducted destructive testing or chemical analysis on incoming materials and chemicals. TI and TI suppliers consider certain information to be proprietary, and thus CAS numbers and other limited information may not be available for release.

In no event shall TI's liability arising out of such information exceed the total purchase price of the TI part(s) at issue in this document sold by TI to Customer on an annual basis.

**OTHER QUALIFIED VERSIONS OF TLV2401, TLV2402 :**

- Automotive : [TLV2401-Q1](#), [TLV2402-Q1](#)

NOTE: Qualified Version Definitions:

- Automotive - Q100 devices qualified for high-reliability automotive applications targeting zero defects

## TAPE AND REEL INFORMATION



### QUADRANT ASSIGNMENTS FOR PIN 1 ORIENTATION IN TAPE



\*All dimensions are nominal

Device	Package Type	Package Drawing	Pins	SPQ	Reel Diameter (mm)	Reel Width W1 (mm)	A0 (mm)	B0 (mm)	K0 (mm)	P1 (mm)	W (mm)	Pin1 Quadrant
TLV2401CDBVR	SOT-23	DBV	5	3000	180.0	8.4	3.2	3.2	1.4	4.0	8.0	Q3
TLV2401CDBVT	SOT-23	DBV	5	250	180.0	8.4	3.2	3.2	1.4	4.0	8.0	Q3
TLV2401CDR	SOIC	D	8	2500	330.0	12.4	6.4	5.2	2.1	8.0	12.0	Q1
TLV2401IDBVR	SOT-23	DBV	5	3000	180.0	8.4	3.2	3.2	1.4	4.0	8.0	Q3
TLV2401IDBVT	SOT-23	DBV	5	250	180.0	8.4	3.2	3.2	1.4	4.0	8.0	Q3
TLV2401IDR	SOIC	D	8	2500	330.0	12.4	6.4	5.2	2.1	8.0	12.0	Q1
TLV2402CDGKR	VSSOP	DGK	8	2500	330.0	12.4	5.3	3.4	1.4	8.0	12.0	Q1
TLV2402CDR	SOIC	D	8	2500	330.0	12.4	6.4	5.2	2.1	8.0	12.0	Q1
TLV2402IDGKR	VSSOP	DGK	8	2500	330.0	12.4	5.3	3.4	1.4	8.0	12.0	Q1
TLV2402IDR	SOIC	D	8	2500	330.0	12.4	6.4	5.2	2.1	8.0	12.0	Q1
TLV2404CPWR	TSSOP	PW	14	2000	330.0	12.4	6.9	5.6	1.6	8.0	12.0	Q1
TLV2404IDR	SOIC	D	14	2500	330.0	16.4	6.5	9.0	2.1	8.0	16.0	Q1
TLV2404IPWR	TSSOP	PW	14	2000	330.0	12.4	6.9	5.6	1.6	8.0	12.0	Q1

**TAPE AND REEL BOX DIMENSIONS**

\*All dimensions are nominal

Device	Package Type	Package Drawing	Pins	SPQ	Length (mm)	Width (mm)	Height (mm)
TLV2401CDBVR	SOT-23	DBV	5	3000	210.0	185.0	35.0
TLV2401CDBVT	SOT-23	DBV	5	250	210.0	185.0	35.0
TLV2401CDR	SOIC	D	8	2500	340.5	338.1	20.6
TLV2401IDBVR	SOT-23	DBV	5	3000	210.0	185.0	35.0
TLV2401IDBVT	SOT-23	DBV	5	250	210.0	185.0	35.0
TLV2401IDR	SOIC	D	8	2500	340.5	338.1	20.6
TLV2402CDGKR	VSSOP	DGK	8	2500	358.0	335.0	35.0
TLV2402CDR	SOIC	D	8	2500	340.5	338.1	20.6
TLV2402IDGKR	VSSOP	DGK	8	2500	358.0	335.0	35.0
TLV2402IDR	SOIC	D	8	2500	340.5	338.1	20.6
TLV2404CPWR	TSSOP	PW	14	2000	356.0	356.0	35.0
TLV2404IDR	SOIC	D	14	2500	350.0	350.0	43.0
TLV2404IPWR	TSSOP	PW	14	2000	356.0	356.0	35.0

**TUBE**

\*All dimensions are nominal

Device	Package Name	Package Type	Pins	SPQ	L (mm)	W (mm)	T (μm)	B (mm)
TLV2401CD	D	SOIC	8	75	507	8	3940	4.32
TLV2401CD	D	SOIC	8	75	505.46	6.76	3810	4
TLV2401ID	D	SOIC	8	75	507	8	3940	4.32
TLV2401ID	D	SOIC	8	75	505.46	6.76	3810	4
TLV2401IP	P	PDIP	8	50	506	13.97	11230	4.32
TLV2402CD	D	SOIC	8	75	505.46	6.76	3810	4
TLV2402CD	D	SOIC	8	75	507	8	3940	4.32
TLV2402ID	D	SOIC	8	75	507	8	3940	4.32
TLV2402ID	D	SOIC	8	75	505.46	6.76	3810	4
TLV2402IDG4	D	SOIC	8	75	507	8	3940	4.32
TLV2402IDG4	D	SOIC	8	75	505.46	6.76	3810	4
TLV2402IP	P	PDIP	8	50	506	13.97	11230	4.32
TLV2404CD	D	SOIC	14	50	505.46	6.76	3810	4
TLV2404CPW	PW	TSSOP	14	90	530	10.2	3600	3.5
TLV2404ID	D	SOIC	14	50	505.46	6.76	3810	4
TLV2404IN	N	PDIP	14	25	506	13.97	11230	4.32
TLV2404IPW	PW	TSSOP	14	90	530	10.2	3600	3.5

# DGK0008A



# PACKAGE OUTLINE

VSSOP - 1.1 mm max height

SMALL OUTLINE PACKAGE

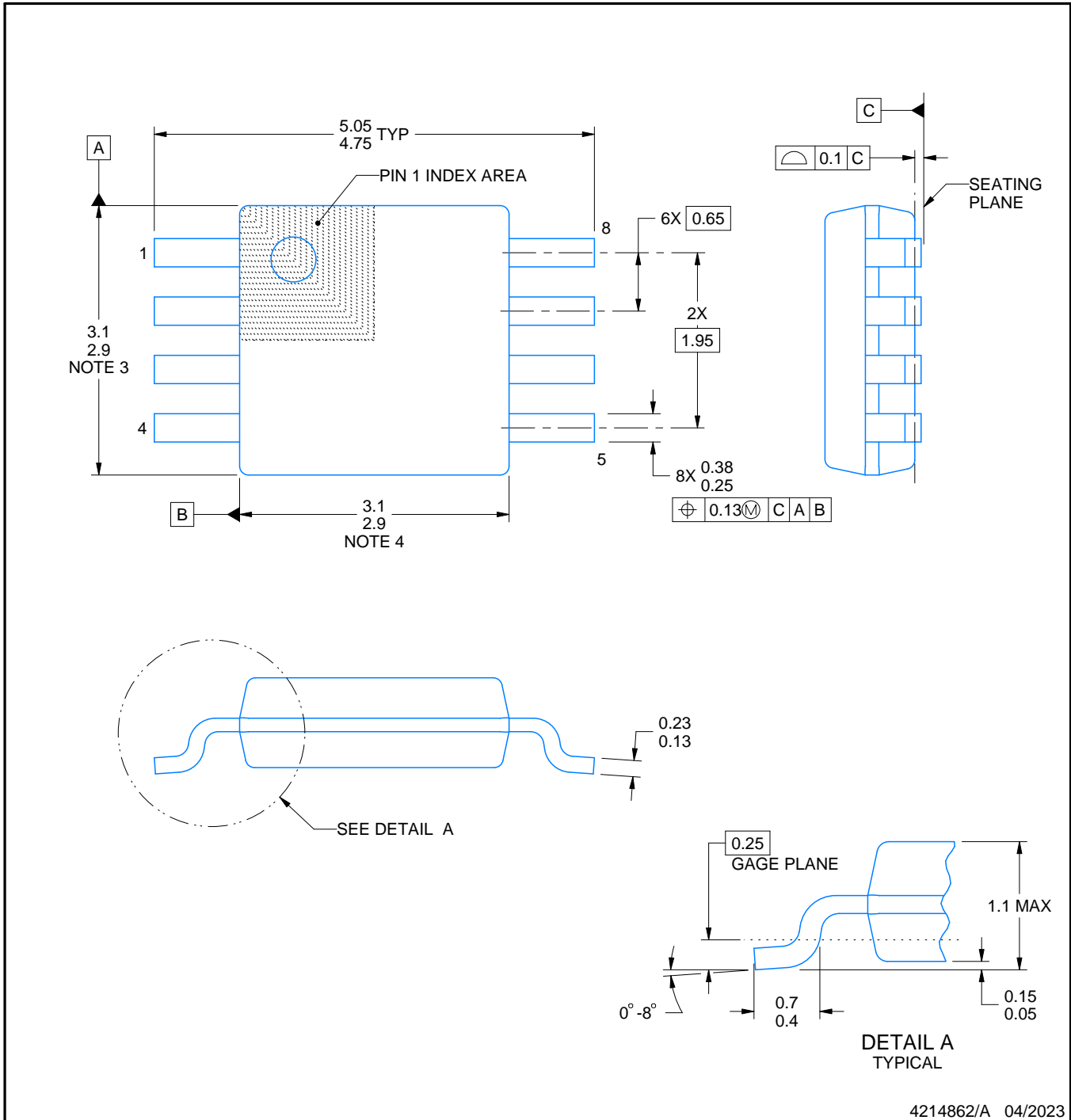

4214862/A 04/2023

**NOTES:**

PowerPAD is a trademark of Texas Instruments.

1. All linear dimensions are in millimeters. Any dimensions in parenthesis are for reference only. Dimensioning and tolerancing per ASME Y14.5M.
2. This drawing is subject to change without notice.
3. This dimension does not include mold flash, protrusions, or gate burrs. Mold flash, protrusions, or gate burrs shall not exceed 0.15 mm per side.
4. This dimension does not include interlead flash. Interlead flash shall not exceed 0.25 mm per side.
5. Reference JEDEC registration MO-187.



# EXAMPLE BOARD LAYOUT

DGK0008A

<sup>TM</sup> VSSOP - 1.1 mm max height

SMALL OUTLINE PACKAGE



LAND PATTERN EXAMPLE  
EXPOSED METAL SHOWN  
SCALE: 15X



4214862/A 04/2023

NOTES: (continued)

6. Publication IPC-7351 may have alternate designs.
7. Solder mask tolerances between and around signal pads can vary based on board fabrication site.
8. Vias are optional depending on application, refer to device data sheet. If any vias are implemented, refer to their locations shown on this view. It is recommended that vias under paste be filled, plugged or tented.
9. Size of metal pad may vary due to creepage requirement.

# EXAMPLE STENCIL DESIGN

DGK0008A

<sup>TM</sup> VSSOP - 1.1 mm max height

SMALL OUTLINE PACKAGE



SOLDER PASTE EXAMPLE  
SCALE: 15X

4214862/A 04/2023

NOTES: (continued)

11. Laser cutting apertures with trapezoidal walls and rounded corners may offer better paste release. IPC-7525 may have alternate design recommendations.
12. Board assembly site may have different recommendations for stencil design.

**DBV0005A****PACKAGE OUTLINE****SOT-23 - 1.45 mm max height**

SMALL OUTLINE TRANSISTOR

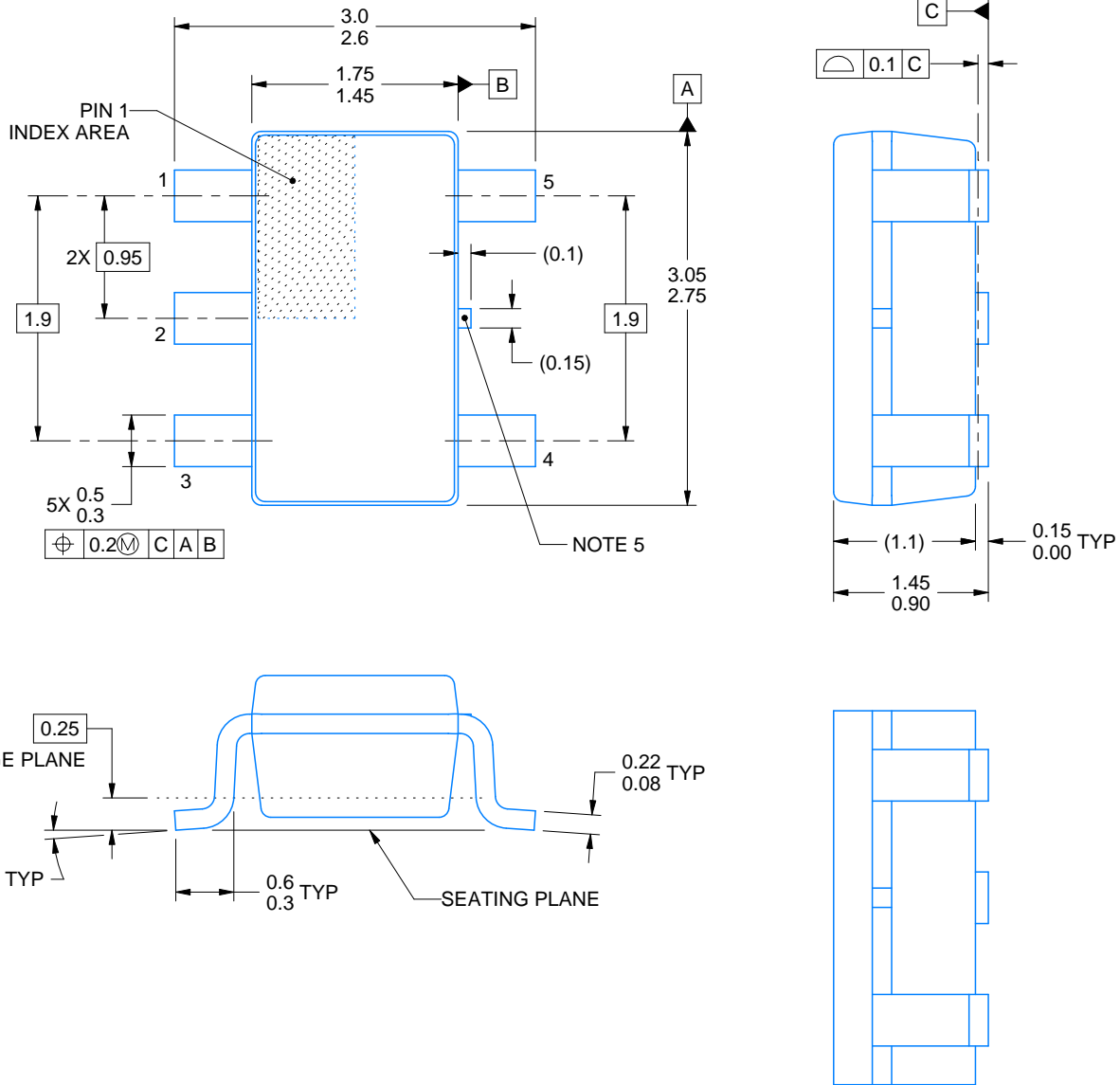

ALTERNATIVE PACKAGE SINGULATION VIEW

4214839/J 02/2024

**NOTES:**

- All linear dimensions are in millimeters. Any dimensions in parenthesis are for reference only. Dimensioning and tolerancing per ASME Y14.5M.
- This drawing is subject to change without notice.
- Reference JEDEC MO-178.
- Body dimensions do not include mold flash, protrusions, or gate burrs. Mold flash, protrusions, or gate burrs shall not exceed 0.25 mm per side.
- Support pin may differ or may not be present.

# EXAMPLE BOARD LAYOUT

DBV0005A

SOT-23 - 1.45 mm max height

SMALL OUTLINE TRANSISTOR

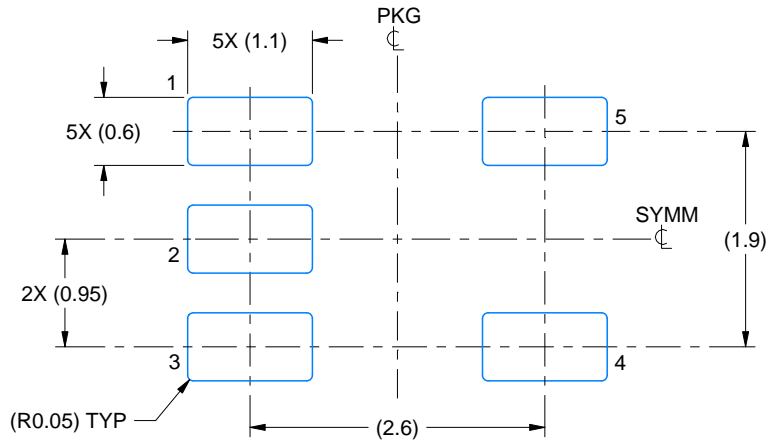

LAND PATTERN EXAMPLE  
EXPOSED METAL SHOWN  
SCALE:15X

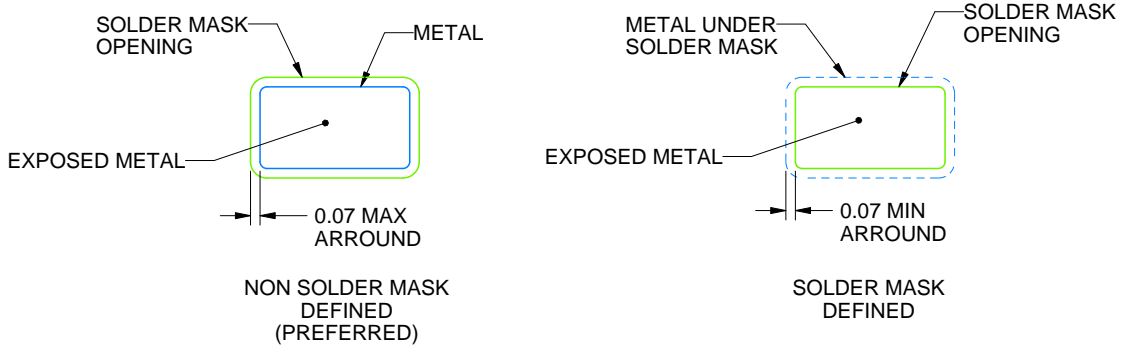

SOLDER MASK DETAILS

4214839/J 02/2024

NOTES: (continued)

- 6. Publication IPC-7351 may have alternate designs.
- 7. Solder mask tolerances between and around signal pads can vary based on board fabrication site.

# EXAMPLE STENCIL DESIGN

DBV0005A

SOT-23 - 1.45 mm max height

SMALL OUTLINE TRANSISTOR



SOLDER PASTE EXAMPLE  
BASED ON 0.125 mm THICK STENCIL  
SCALE:15X

4214839/J 02/2024

NOTES: (continued)

8. Laser cutting apertures with trapezoidal walls and rounded corners may offer better paste release. IPC-7525 may have alternate design recommendations.
9. Board assembly site may have different recommendations for stencil design.

D (R-PDSO-G14)

PLASTIC SMALL OUTLINE



- NOTES:
- A. All linear dimensions are in inches (millimeters).
  - B. This drawing is subject to change without notice.
  - $\triangle C$  Body length does not include mold flash, protrusions, or gate burrs. Mold flash, protrusions, or gate burrs shall not exceed 0.006 (0,15) each side.
  - $\triangle D$  Body width does not include interlead flash. Interlead flash shall not exceed 0.017 (0,43) each side.
  - E. Reference JEDEC MS-012 variation AB.

D (R-PDSO-G14)

PLASTIC SMALL OUTLINE



- NOTES:
- All linear dimensions are in millimeters.
  - This drawing is subject to change without notice.
  - Publication IPC-7351 is recommended for alternate designs.
  - Laser cutting apertures with trapezoidal walls and also rounding corners will offer better paste release. Customers should contact their board assembly site for stencil design recommendations. Refer to IPC-7525 for other stencil recommendations.
  - Customers should contact their board fabrication site for solder mask tolerances between and around signal pads.

PW (R-PDSO-G14)

PLASTIC SMALL OUTLINE



- NOTES:
- A. All linear dimensions are in millimeters. Dimensioning and tolerancing per ASME Y14.5M-1994.
  - B. This drawing is subject to change without notice.
  - C. Body length does not include mold flash, protrusions, or gate burrs. Mold flash, protrusions, or gate burrs shall not exceed 0,15 each side.
  - D. Body width does not include interlead flash. Interlead flash shall not exceed 0,25 each side.
  - E. Falls within JEDEC MO-153



PW (R-PDSO-G14)

PLASTIC SMALL OUTLINE



- NOTES:
- All linear dimensions are in millimeters.
  - This drawing is subject to change without notice.
  - Publication IPC-7351 is recommended for alternate designs.
  - Laser cutting apertures with trapezoidal walls and also rounding corners will offer better paste release. Customers should contact their board assembly site for stencil design recommendations. Refer to IPC-7525 for other stencil recommendations.
  - Customers should contact their board fabrication site for solder mask tolerances between and around signal pads.



D0008A

# PACKAGE OUTLINE

SOIC - 1.75 mm max height

SMALL OUTLINE INTEGRATED CIRCUIT



NOTES:

1. Linear dimensions are in inches [millimeters]. Dimensions in parenthesis are for reference only. Controlling dimensions are in inches. Dimensioning and tolerancing per ASME Y14.5M.
2. This drawing is subject to change without notice.
3. This dimension does not include mold flash, protrusions, or gate burrs. Mold flash, protrusions, or gate burrs shall not exceed .006 [0.15] per side.
4. This dimension does not include interlead flash.
5. Reference JEDEC registration MS-012, variation AA.

# EXAMPLE BOARD LAYOUT

D0008A

SOIC - 1.75 mm max height

SMALL OUTLINE INTEGRATED CIRCUIT



LAND PATTERN EXAMPLE  
EXPOSED METAL SHOWN  
SCALE:8X



SOLDER MASK DETAILS

4214825/C 02/2019

NOTES: (continued)

6. Publication IPC-7351 may have alternate designs.

7. Solder mask tolerances between and around signal pads can vary based on board fabrication site.

# EXAMPLE STENCIL DESIGN

D0008A

SOIC - 1.75 mm max height

SMALL OUTLINE INTEGRATED CIRCUIT



SOLDER PASTE EXAMPLE  
BASED ON .005 INCH [0.125 MM] THICK STENCIL  
SCALE:8X

4214825/C 02/2019

NOTES: (continued)

8. Laser cutting apertures with trapezoidal walls and rounded corners may offer better paste release. IPC-7525 may have alternate design recommendations.
9. Board assembly site may have different recommendations for stencil design.

P (R-PDIP-T8)

PLASTIC DUAL-IN-LINE PACKAGE



- NOTES:
- A. All linear dimensions are in inches (millimeters).
  - B. This drawing is subject to change without notice.
  - C. Falls within JEDEC MS-001 variation BA.

N (R-PDIP-T\*\*)

PLASTIC DUAL-IN-LINE PACKAGE

16 PINS SHOWN



- NOTES:
- A. All linear dimensions are in inches (millimeters).
  - B. This drawing is subject to change without notice.
  - $\triangle C$  Falls within JEDEC MS-001, except 18 and 20 pin minimum body length (Dim A).
  - $\triangle D$  The 20 pin end lead shoulder width is a vendor option, either half or full width.

## IMPORTANT NOTICE AND DISCLAIMER

TI PROVIDES TECHNICAL AND RELIABILITY DATA (INCLUDING DATA SHEETS), DESIGN RESOURCES (INCLUDING REFERENCE DESIGNS), APPLICATION OR OTHER DESIGN ADVICE, WEB TOOLS, SAFETY INFORMATION, AND OTHER RESOURCES "AS IS" AND WITH ALL FAULTS, AND DISCLAIMS ALL WARRANTIES, EXPRESS AND IMPLIED, INCLUDING WITHOUT LIMITATION ANY IMPLIED WARRANTIES OF MERCHANTABILITY, FITNESS FOR A PARTICULAR PURPOSE OR NON-INFRINGEMENT OF THIRD PARTY INTELLECTUAL PROPERTY RIGHTS.

These resources are intended for skilled developers designing with TI products. You are solely responsible for (1) selecting the appropriate TI products for your application, (2) designing, validating and testing your application, and (3) ensuring your application meets applicable standards, and any other safety, security, regulatory or other requirements.

These resources are subject to change without notice. TI grants you permission to use these resources only for development of an application that uses the TI products described in the resource. Other reproduction and display of these resources is prohibited. No license is granted to any other TI intellectual property right or to any third party intellectual property right. TI disclaims responsibility for, and you will fully indemnify TI and its representatives against, any claims, damages, costs, losses, and liabilities arising out of your use of these resources.

TI's products are provided subject to [TI's Terms of Sale](#) or other applicable terms available either on [ti.com](https://www.ti.com) or provided in conjunction with such TI products. TI's provision of these resources does not expand or otherwise alter TI's applicable warranties or warranty disclaimers for TI products.

TI objects to and rejects any additional or different terms you may have proposed.

Mailing Address: Texas Instruments, Post Office Box 655303, Dallas, Texas 75265  
Copyright © 2024, Texas Instruments Incorporated