

TLV247x-Q1, TLV247xA-Q1

FAMILY OF 600- μ A/Ch 2.8-MHz RAIL-TO-RAIL INPUT/OUTPUT HIGH-DRIVE OPERATIONAL AMPLIFIERS

SGLS180B – AUGUST 2003 – REVISED APRIL 2008

- **Qualified for Automotive Applications**
- **ESD Protection Exceeds 2000 V Per MIL-STD-883, Method 3015; Exceeds 200 V Using Machine Model (C = 200 pF, R = 0)**
- **CMOS Rail-To-Rail Input/Output**
- **Input Bias Current . . . 2.5 pA**
- **Low Supply Current . . . 600 μ A/Channel**
- **Gain-Bandwidth Product . . . 2.8 MHz**
- **High Output Drive Capability**
 - ± 10 mA at 180 mV
 - ± 35 mA at 500 mV
- **Input Offset Voltage . . . 250 μ V (typ)**
- **Supply Voltage Range . . . 2.7 V to 6 V**

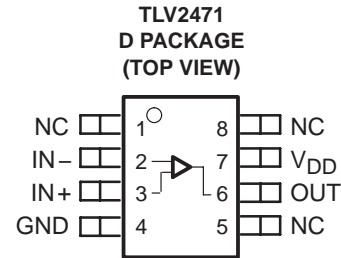

description

The TLV247x is a family of CMOS rail-to-rail input/output operational amplifiers that establishes a new performance point for supply current versus ac performance. These devices consume just 600 μ A/channel while offering 2.8 MHz of gain-bandwidth product. Along with increased ac performance, the amplifier provides high output drive capability, solving a major shortcoming of older micropower operational amplifiers. The TLV247x can swing to within 180 mV of each supply rail while driving a 10-mA load. For non-RRO applications, the TLV247x can supply ± 35 mA at 500 mV off the rail. Both the inputs and outputs swing rail-to-rail for increased dynamic range in low-voltage applications. This performance makes the TLV247x family ideal for sensor interface, portable medical equipment, and other data acquisition circuits.

The family is fully specified at 3 V and 5 V across the automotive temperature range (-40°C to 125°C).

FAMILY TABLE

DEVICE	NUMBER OF CHANNELS	UNIVERSAL EVM BOARD
TLV2471	1	See the EVM selection guide (SLOU060)
TLV2472	2	
TLV2474	4	

A SELECTION OF SINGLE-SUPPLY OPERATIONAL AMPLIFIER PRODUCTS[†]

DEVICE	V_{DD} (V)	V_{IO} (μ V)	BW (MHz)	SLEW RATE (V/ μ s)	I_{DD} (per channel) (μ A)	OUTPUT DRIVE	RAIL-TO-RAIL
TLV247X	2.7 – 6	250	2.8	1.5	600	± 35 mA	I/O
TLV245X	2.7 – 6	20	0.22	0.11	23	± 10 mA	I/O
TLV246X	2.7 – 6	150	6.4	1.6	550	± 90 mA	I/O
TLV277X	2.5 – 6	360	5.1	10.5	1000	± 10 mA	O

[†] All specifications measured at 5 V.



Please be aware that an important notice concerning availability, standard warranty, and use in critical applications of Texas Instruments semiconductor products and disclaimers thereto appears at the end of this data sheet.

PRODUCTION DATA information is current as of publication date. Products conform to specifications per the terms of Texas Instruments standard warranty. Production processing does not necessarily include testing of all parameters.



POST OFFICE BOX 655303 • DALLAS, TEXAS 75265

Copyright © 2008 Texas Instruments Incorporated

TLV247x-Q1, TLV247xA-Q1

FAMILY OF 600- μ A/Ch 2.8-MHz RAIL-TO-RAIL INPUT/OUTPUT

HIGH-DRIVE OPERATIONAL AMPLIFIERS

SGLS180B – AUGUST 2003 – REVISED APRIL 2008

ORDERING INFORMATION†

T _A	PACKAGE‡		ORDERABLE PART NUMBER	TOP-SIDE MARKING
-40°C to 125°C	SOP – D	Tape and reel	TLV2471QDRQ1	2471Q1
	SOP – D	Tape and reel	TLV2471AQDRQ1	2471AQ
	SOT23 – DBV	Tape and reel	TLV2471QDBVRQ1	471Q
-40°C to 125°C	SOP – D	Tape and reel	TLV2472QDRQ1	2472Q1
	SOP – D	Tape and reel	TLV2472AQDRQ1	2472AQ
	MSOP – DGN	Tape and reel	TLV2472QDGNRQ1§	
-40°C to 125°C	SOP – D	Tape and reel	TLV2474QDRQ1	2474Q1
	SOP – D	Tape and reel	TLV2474AQDRQ1	2474AQ1
	TSSOP – PWP	Tape and reel	TLV2474QPWPRQ1	2474Q1
	TSSOP – PWP	Tape and reel	TLV2474APWPRQ1	2474AQ1

† For the most current package and ordering information, see the Package Option Addendum at the end of this document, or see the TI web site at <http://www.ti.com>.

‡ Package drawings, thermal data, and symbolization are available at <http://www.ti.com/packaging>.

§ Product Preview.

TLV247x PACKAGE PINOUTS

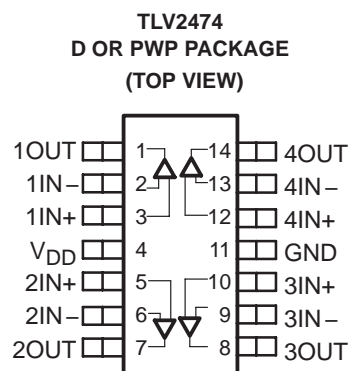
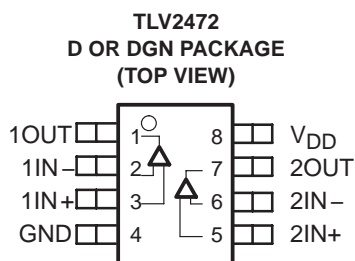
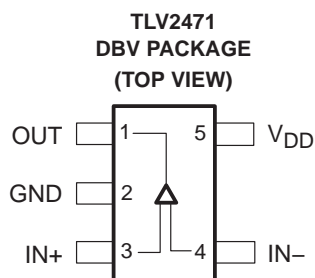

NC – No internal connection

TLV247x-Q1, TLV247xA-Q1
FAMILY OF 600- μ A/Ch 2.8-MHz RAIL-TO-RAIL INPUT/OUTPUT
HIGH-DRIVE OPERATIONAL AMPLIFIERS

SGLS180B – AUGUST 2003 – REVISED APRIL 2008

absolute maximum ratings over operating free-air temperature range (unless otherwise noted)†

Supply voltage, V_{DD} (see Note 1)	7 V
Differential input voltage, V_{ID}	$\pm V_{DD}$
Continuous total power dissipation	See Dissipation Rating Table
Operating free-air temperature range,	-40°C to 125°C
Maximum junction temperature, T_J	150°C
Storage temperature range, T_{stg}	-65°C to 150°C
Lead temperature 1,6 mm (1/16 inch) from case for 10 seconds	260°C

† Stresses beyond those listed under “absolute maximum ratings” may cause permanent damage to the device. These are stress ratings only, and functional operation of the device at these or any other conditions beyond those indicated under “recommended operating conditions” is not implied. Exposure to absolute-maximum-rated conditions for extended periods may affect device reliability.

NOTE: All voltage values, except differential voltages, are with respect to GND.

DISSIPATION RATING TABLE

PACKAGE	θ_{JC} ($^{\circ}\text{C}/\text{W}$)	θ_{JA} ($^{\circ}\text{C}/\text{W}$)	$T_A \leq 25^{\circ}\text{C}$ POWER RATING
D (8)	38.3	176	710 mW
D (14)	26.9	122.3	1022 mW
DBV (3)	55	324.1	385 mW
DGN (8)	4.7	52.7	2370 mW
PWP (14)	2.07	30.7	4070 mW

recommended operating conditions

		MIN	MAX	UNIT
Supply voltage, V_{DD}	Single supply	2.7	6	V
	Split supply	± 1.35	± 3	
Common-mode input voltage range, V_{ICR}		0	V_{DD}	V
Operating free-air temperature, T_A		-40	125	$^{\circ}\text{C}$

† Relative to GND



TLV247x-Q1, TLV247xA-Q1
FAMILY OF 600- μ A/Ch 2.8-MHz RAIL-TO-RAIL INPUT/OUTPUT
HIGH-DRIVE OPERATIONAL AMPLIFIERS

SGLS180B – AUGUST 2003 – REVISED APRIL 2008

electrical characteristics at specified free-air temperature, $V_{DD} = 3\text{ V}$ (unless otherwise noted)

PARAMETER		TEST CONDITIONS		T_A^\dagger	MIN	TYP	MAX	UNIT
V_{IO}	Input offset voltage	$V_{IC} = V_{DD}/2,$ $V_O = V_{DD}/2,$ $R_S = 50\ \Omega$	TLV247x	25°C	250	2200		μV
				Full range		2400		
			TLV247xA	25°C	250	1600		
				Full range		1800		
α_{VIO}	Temperature coefficient of input offset voltage	$V_{IC} = V_{DD}/2,$ $V_O = V_{DD}/2,$ $R_S = 50\ \Omega$			0.4		$\mu\text{V}/^\circ\text{C}$	
I_{IO}	Input offset current	$V_{IC} = V_{DD}/2,$ $V_O = V_{DD}/2,$ $R_S = 50\ \Omega$	25°C	1.5	50		pA	
			Full range		300			
I_{IB}	Input bias current	$V_{IC} = V_{DD}/2,$ $V_O = V_{DD}/2,$ $R_S = 50\ \Omega$	25°C	2	50		pA	
			Full range		300			
V_{OH}	High-level output voltage	$V_{IC} = V_{DD}/2$	$I_{OH} = -2.5\ \text{mA}$	25°C	2.85	2.94		V
				Full range		2.8		
			$I_{OH} = -10\ \text{mA}$	25°C	2.6	2.74		
				Full range		2.5		
V_{OL}	Low-level output voltage	$V_{IC} = V_{DD}/2$	$I_{OL} = 2.5\ \text{mA}$	25°C	0.07	0.15		V
				Full range		0.2		
			$I_{OL} = 10\ \text{mA}$	25°C	0.2	0.35		
				Full range		0.5		
I_{OS}	Short-circuit output current		Sourcing	25°C	30		mA	
				Full range		20		
			Sinking	25°C	30			
				Full range		20		
I_O	Output current	$V_O = 0.5\ \text{V}$ from rail	25°C	± 22		mA		
A_{VD}	Large-signal differential voltage amplification	$V_O(\text{PP}) = 1\ \text{V},$	$R_L = 10\ \text{k}\Omega$	25°C	90	116	dB	
				Full range		88		
$r_{i(d)}$	Differential input resistance			25°C		10^{12}	Ω	
C_{IC}	Common-mode input capacitance	$f = 10\ \text{kHz}$		25°C		19.3	pF	
z_o	Closed-loop output impedance	$f = 10\ \text{kHz},$	$A_V = 10$	25°C		2	Ω	
CMRR	Common-mode rejection ratio	$V_{IC} = 0\ \text{to}\ 3\ \text{V},$ $R_S = 50\ \Omega$	25°C	58	78	dB		
			Full range		56			
k_{SVR}	Supply voltage rejection ratio ($\Delta V_{DD} / \Delta V_{IO}$)	$V_{DD} = 2.7\ \text{V to}\ 6\ \text{V},$ No load	$V_{IC} = V_{DD}/2,$	25°C	68	90	dB	
				Full range		60		
		$V_{DD} = 3\ \text{V to}\ 5\ \text{V},$ No load	$V_{IC} = V_{DD}/2,$	25°C	70	92		
				Full range		60		
I_{DD}	Supply current (per channel)	$V_O = 1.5\ \text{V},$	No load	25°C	550	750	μA	
				Full range		800		

† Full range is -40°C to 125°C . If not specified, full range is -40°C to 125°C .



TLV247x-Q1, TLV247xA-Q1
FAMILY OF 600- μ A/Ch 2.8-MHz RAIL-TO-RAIL INPUT/OUTPUT
HIGH-DRIVE OPERATIONAL AMPLIFIERS

SGLS180B – AUGUST 2003 – REVISED APRIL 2008

operating characteristics at specified free-air temperature, $V_{DD} = 3$ V (unless otherwise noted)

PARAMETER		TEST CONDITIONS		T_A †	MIN	TYP	MAX	UNIT
SR	Slew rate at unity gain	$V_{O(PP)} = 0.8$ V, $R_L = 10$ k Ω	$C_L = 150$ pF,	25°C	1.1	1.4		V/ μ s
				Full range	0.6			
V_n	Equivalent input noise voltage			25°C	28			nV/ $\sqrt{\text{Hz}}$
				25°C	15			
I_n	Equivalent input noise current	f = 1 kHz		25°C	0.405		pA/ $\sqrt{\text{Hz}}$	
THD + N	Total harmonic distortion plus noise	$V_{O(PP)} = 2$ V, $R_L = 10$ k Ω , f = 1 kHz		25°C	$A_V = 1$		0.02%	
					$A_V = 10$		0.1%	
					$A_V = 100$		0.5%	
Gain-bandwidth product		f = 10 kHz,	$R_L = 600$ Ω	25°C	2.8		MHz	
t_s	Settling time	$V_{(\text{STEP})PP} = 2$ V, $A_V = -1$, $C_L = 10$ pF, $R_L = 10$ k Ω		25°C	0.1%		1.5	μ s
					0.01%		3.9	
		$V_{(\text{STEP})PP} = 2$ V, $A_V = -1$, $C_L = 56$ pF, $R_L = 10$ k Ω			0.1%		1.6	
					0.01%		4	
ϕ_m	Phase margin	$R_L = 10$ k Ω ,	$C_L = 1000$ pF	25°C	61°			
	Gain margin	$R_L = 10$ k Ω ,	$C_L = 1000$ pF	25°C	15		dB	

† Full range is -40°C to 125°C . If not specified, full range is -40°C to 125°C .

‡ Depending on package dissipation rating

TLV247x-Q1, TLV247xA-Q1
FAMILY OF 600- μ A/Ch 2.8-MHz RAIL-TO-RAIL INPUT/OUTPUT
HIGH-DRIVE OPERATIONAL AMPLIFIERS

SGLS180B – AUGUST 2003 – REVISED APRIL 2008

electrical characteristics at specified free-air temperature, $V_{DD} = 5\text{ V}$ (unless otherwise noted)

PARAMETER		TEST CONDITIONS		T_A^\dagger	MIN	TYP	MAX	UNIT
V_{IO}	Input offset voltage	$V_{IC} = V_{DD}/2,$ $V_O = V_{DD}/2,$ $R_S = 50\ \Omega$	TLV247x	25°C	250	2200	μV	
				Full range	2400			
			TLV247xA	25°C	250	1600		
				Full range	2000			
α_{VIO}	Temperature coefficient of input offset voltage	$V_{IC} = V_{DD}/2,$ $V_O = V_{DD}/2,$ $R_S = 50\ \Omega$			0.4		$\mu\text{V}/^\circ\text{C}$	
I_{IO}	Input offset current	$V_{IC} = V_{DD}/2,$ $V_O = V_{DD}/2,$ $R_S = 50\ \Omega$	25°C	1.7	50	pA		
			Full range	300				
I_{IB}	Input bias current	$V_{IC} = V_{DD}/2,$ $V_O = V_{DD}/2,$ $R_S = 50\ \Omega$	25°C	2.5	50	pA		
			Full range	300				
V_{OH}	High-level output voltage	$V_{IC} = V_{DD}/2$	$I_{OH} = -2.5\ \text{mA}$	25°C	4.85	4.96	V	
				Full range	4.8			
			$I_{OH} = -10\ \text{mA}$	25°C	4.72	4.82		
				Full range	4.65			
V_{OL}	Low-level output voltage	$V_{IC} = V_{DD}/2$	$I_{OL} = 2.5\ \text{mA}$	25°C	0.07	0.15	V	
				Full range	0.2			
			$I_{OL} = 10\ \text{mA}$	25°C	0.178	0.28		
				Full range	0.35			
I_{OS}	Short-circuit output current		Sourcing	25°C	110	mA		
				Full range	60			
			Sinking	25°C	90			
				Full range	60			
I_O	Output current	$V_O = 0.5\ \text{V}$ from rail	25°C	± 35	mA			
A_{VD}	Large-signal differential voltage amplification	$V_O(\text{PP}) = 3\ \text{V},$	$R_L = 10\ \text{k}\Omega$	25°C	92	120	dB	
				Full range	91			
$r_{i(d)}$	Differential input resistance			25°C	10^{12}	Ω		
C_{IC}	Common-mode input capacitance	$f = 10\ \text{kHz}$		25°C	18.9	pF		
z_o	Closed-loop output impedance	$f = 10\ \text{kHz},$	$A_V = 10$	25°C	1.8	Ω		
CMRR	Common-mode rejection ratio	$V_{IC} = 0\ \text{to}\ 5\ \text{V},$ $R_S = 50\ \Omega$	25°C	62	84	dB		
			Full range	58				
k_{SVR}	Supply voltage rejection ratio ($\Delta V_{DD} / \Delta V_{IO}$)	$V_{DD} = 2.7\ \text{V to}\ 6\ \text{V},$ No load	$V_{IC} = V_{DD}/2,$	25°C	68	90	dB	
				Full range	60			
		$V_{DD} = 3\ \text{V to}\ 5\ \text{V},$ No load	$V_{IC} = V_{DD}/2,$	25°C	70	92		
				Full range	60			
I_{DD}	Supply current (per channel)	$V_O = 2.5\ \text{V},$	No load	25°C	600	900	μA	
				Full range	1000			

† Full range is -40°C to 125°C . If not specified, full range is -40°C to 125°C .



TLV247x-Q1, TLV247xA-Q1
FAMILY OF 600- μ A/Ch 2.8-MHz RAIL-TO-RAIL INPUT/OUTPUT
HIGH-DRIVE OPERATIONAL AMPLIFIERS

SGLS180B – AUGUST 2003 – REVISED APRIL 2008

operating characteristics at specified free-air temperature, $V_{DD} = 5\text{ V}$ (unless otherwise noted)

PARAMETER		TEST CONDITIONS		T_A †	MIN	TYP	MAX	UNIT
SR	Slew rate at unity gain	$V_{O(PP)} = 2\text{ V}$, $R_L = 10\text{ k}\Omega$	$C_L = 150\text{ pF}$	25°C	1.1	1.5		V/ μ s
				Full range	0.7			
V_n	Equivalent input noise voltage	f = 100 Hz		25°C		28		nV/ $\sqrt{\text{Hz}}$
		f = 1 kHz		25°C		15		
I_n	Equivalent input noise current	f = 1 kHz		25°C		0.39		pA/ $\sqrt{\text{Hz}}$
THD + N	Total harmonic distortion plus noise	$V_{O(PP)} = 4\text{ V}$, $R_L = 10\text{ k}\Omega$, f = 1 kHz	$A_V = 1$	25°C		0.01%		
			$A_V = 10$			0.05%		
			$A_V = 100$			0.3%		
Gain-bandwidth product		f = 10 kHz,	$R_L = 600\ \Omega$	25°C		2.8		MHz
t_s	Settling time	$V(\text{STEP})_{PP} = 2\text{ V}$, $A_V = -1$, $C_L = 10\text{ pF}$, $R_L = 10\text{ k}\Omega$	0.1%	25°C		1.8		μ s
			0.01%			3.3		
		$V(\text{STEP})_{PP} = 2\text{ V}$, $A_V = -1$, $C_L = 56\text{ pF}$, $R_L = 10\text{ k}\Omega$	0.1%			1.7		
			0.01%			3		
ϕ_m	Phase margin	$R_L = 10\text{ k}\Omega$,	$C_L = 1000\text{ pF}$	25°C		68°		
	Gain margin	$R_L = 10\text{ k}\Omega$,	$C_L = 1000\text{ pF}$	25°C		23		dB

† Full range is -40°C to 125°C for Q suffix. If not specified, full range is -40°C to 125°C .

TLV247x-Q1, TLV247xA-Q1
FAMILY OF 600- μ A/Ch 2.8-MHz RAIL-TO-RAIL INPUT/OUTPUT
HIGH-DRIVE OPERATIONAL AMPLIFIERS

SGLS180B – AUGUST 2003 – REVISED APRIL 2008

TYPICAL CHARACTERISTICS

Table of Graphs

			FIGURE
V_{IO}	Input offset voltage	vs Common-mode input voltage	1, 2
I_{IB}	Input bias current	vs Free-air temperature	3, 4
I_{IO}	Input offset current		
V_{OH}	High-level output voltage	vs High-level output current	5, 7
V_{OL}	Low-level output voltage	vs Low-level output current	6, 8
Z_o	Output impedance	vs Frequency	9
I_{DD}	Supply current	vs Supply voltage	10
PSRR	Power supply rejection ratio	vs Frequency	11
CMRR	Common-mode rejection ratio	vs Frequency	12
V_n	Equivalent input noise voltage	vs Frequency	13
$V_{O(PP)}$	Maximum peak-to-peak output voltage	vs Frequency	14, 15
A_{VD}	Differential voltage gain and phase	vs Frequency	16, 17
ϕ_m	Phase margin	vs Load capacitance	18, 19
	Gain margin	vs Load capacitance	20, 21
SR	Slew rate	vs Supply voltage	22
		vs Free-air temperature	23
		vs Frequency	24, 25
	Crosstalk	vs Frequency	26
THD+N	Total harmonic distortion + noise	vs Frequency	27, 28
V_O	Large and small signal follower	vs Time	29 – 32



TLV247x-Q1, TLV247xA-Q1 FAMILY OF 600- μ A/Ch 2.8-MHz RAIL-TO-RAIL INPUT/OUTPUT HIGH-DRIVE OPERATIONAL AMPLIFIERS

SGLS180B – AUGUST 2003 – REVISED APRIL 2008

TYPICAL CHARACTERISTICS

**INPUT OFFSET VOLTAGE
vs
COMMON-MODE INPUT VOLTAGE**

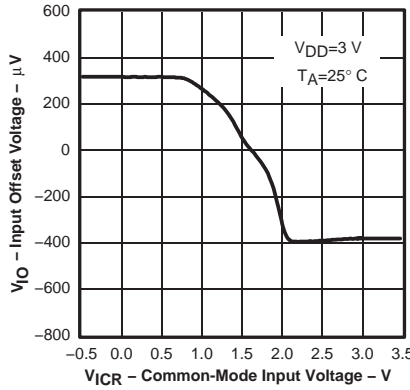

Figure 1

**INPUT OFFSET VOLTAGE
vs
COMMON-MODE INPUT VOLTAGE**

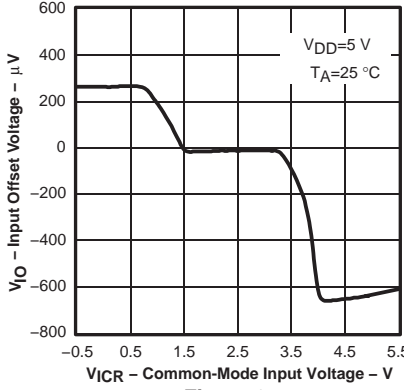

Figure 2

**INPUT BIAS AND INPUT OFFSET
CURRENTS
vs
FREE-AIR TEMPERATURE**

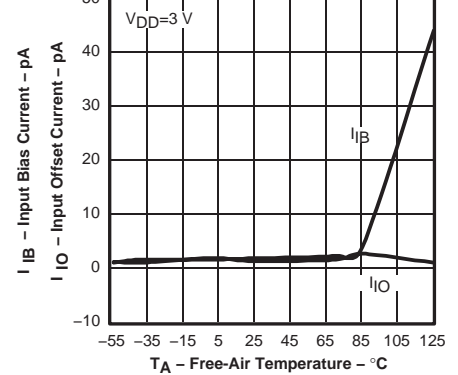

Figure 3

**INPUT BIAS AND INPUT OFFSET
CURRENTS
vs
FREE-AIR TEMPERATURE**

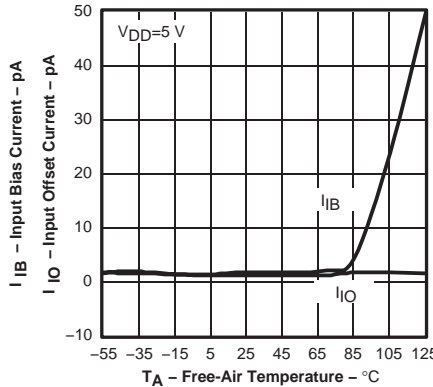

Figure 4

**HIGH-LEVEL OUTPUT VOLTAGE
vs
HIGH-LEVEL OUTPUT CURRENT**

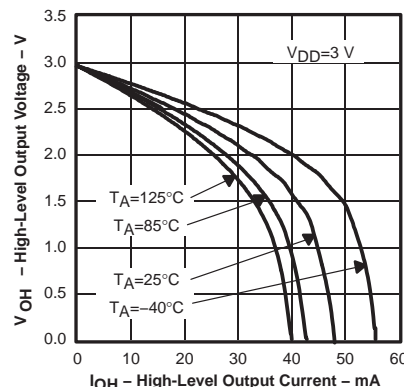

Figure 5

**LOW-LEVEL OUTPUT VOLTAGE
vs
LOW-LEVEL OUTPUT CURRENT**

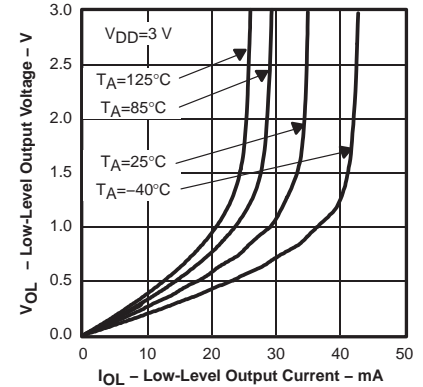

Figure 6

**HIGH-LEVEL OUTPUT VOLTAGE
vs
HIGH-LEVEL OUTPUT CURRENT**

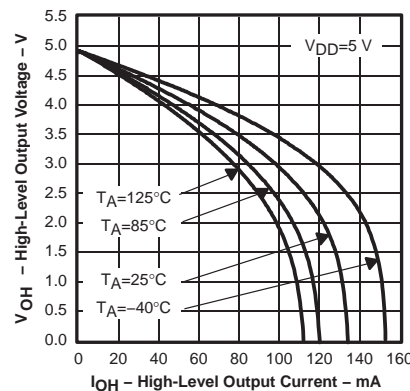

Figure 7

**LOW-LEVEL OUTPUT VOLTAGE
vs
LOW-LEVEL OUTPUT CURRENT**

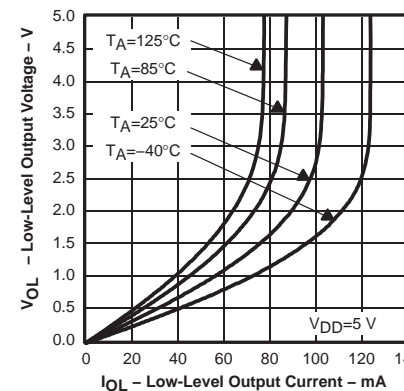

Figure 8

**OUTPUT IMPEDANCE
vs
FREQUENCY**

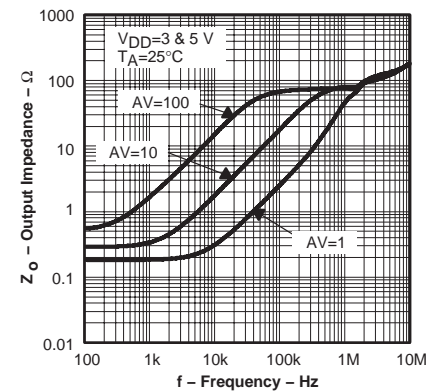

Figure 9



TLV247x-Q1, TLV247xA-Q1 FAMILY OF 600- μ A/Ch 2.8-MHz RAIL-TO-RAIL INPUT/OUTPUT HIGH-DRIVE OPERATIONAL AMPLIFIERS

SGLS180B – AUGUST 2003 – REVISED APRIL 2008

TYPICAL CHARACTERISTICS

**SUPPLY CURRENT
vs
SUPPLY VOLTAGE**

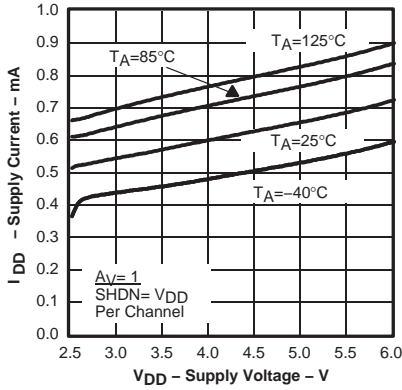

Figure 10

**POWER SUPPLY REJECTION RATIO
vs
FREQUENCY**

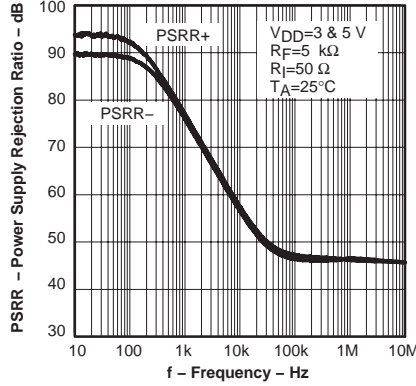

Figure 11

**COMMON-MODE REJECTION RATIO
vs
FREQUENCY**

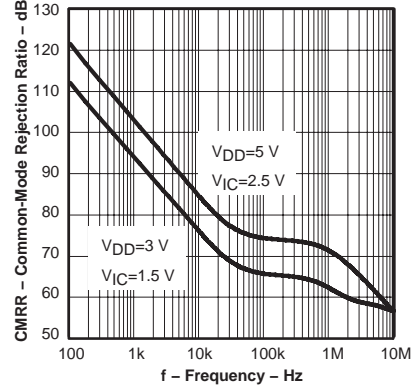

Figure 12

**EQUIVALENT NOISE VOLTAGE
vs
FREQUENCY**

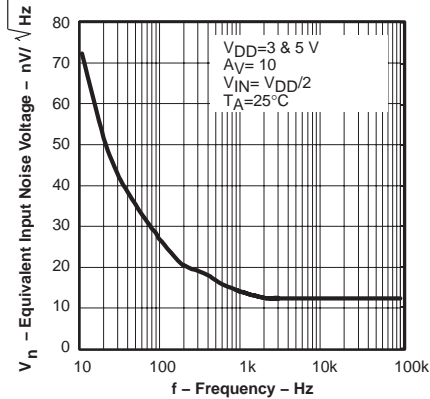

Figure 13

**MAXIMUM PEAK-TO-PEAK
OUTPUT VOLTAGE
vs
FREQUENCY**

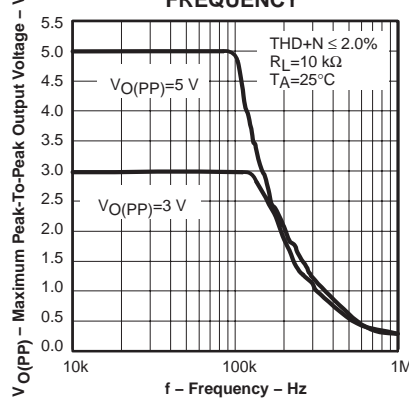

Figure 14

**MAXIMUM PEAK-TO-PEAK
OUTPUT VOLTAGE
vs
FREQUENCY**

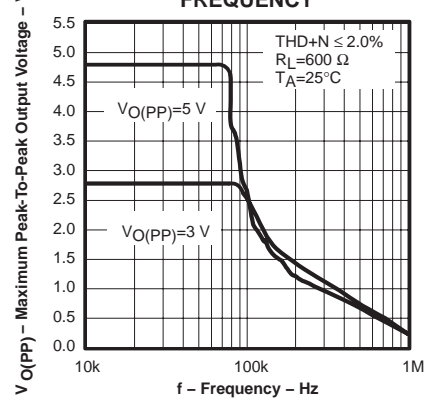

Figure 15

**DIFFERENTIAL VOLTAGE GAIN AND PHASE
vs
FREQUENCY**

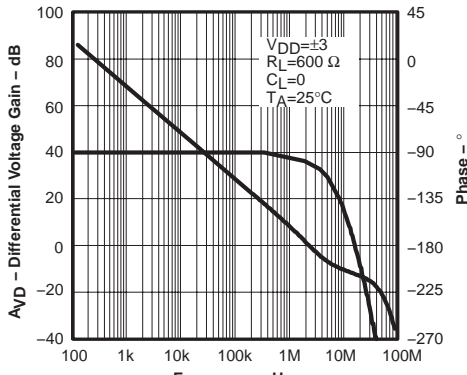

Figure 16

**DIFFERENTIAL VOLTAGE GAIN AND PHASE
vs
FREQUENCY**

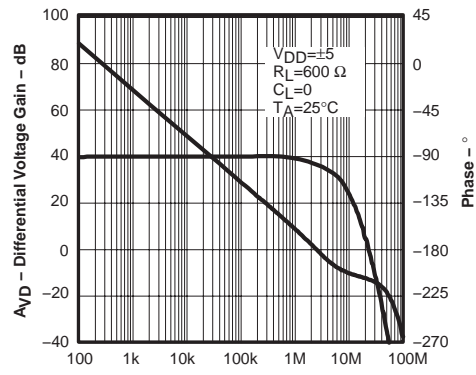
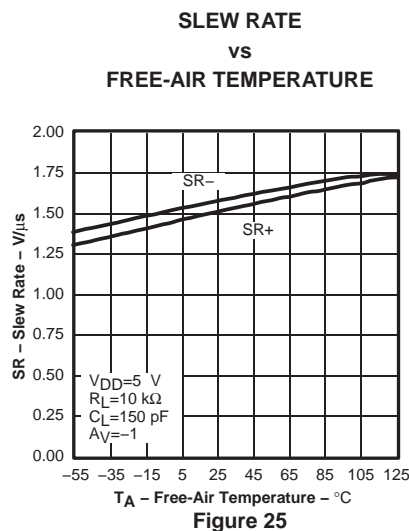
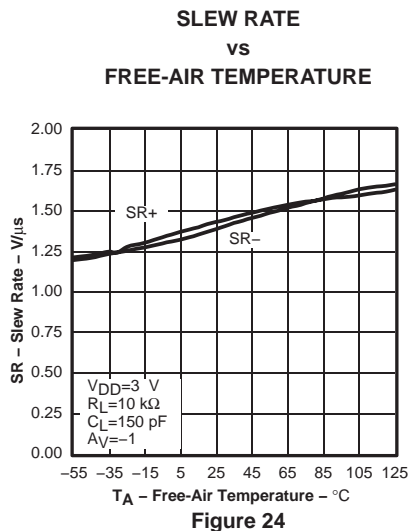
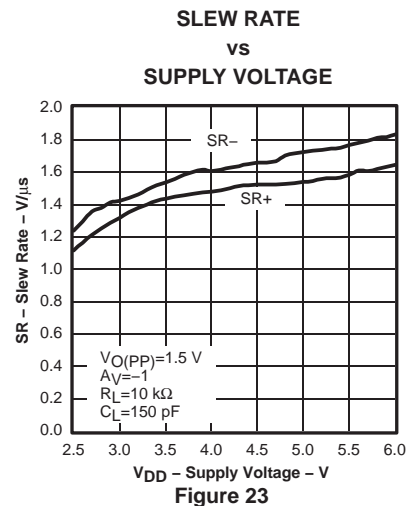
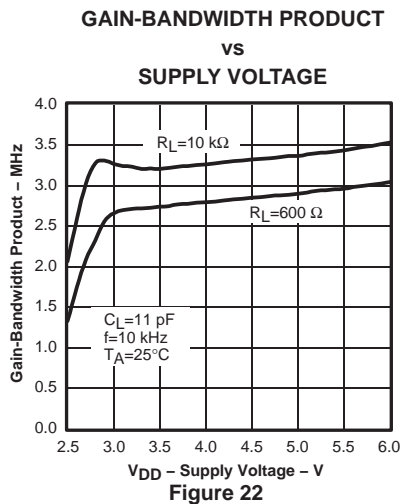
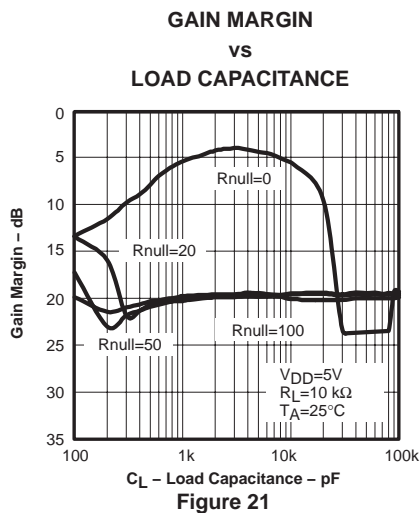
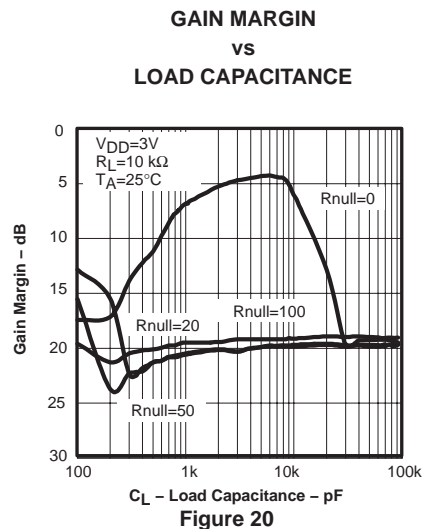
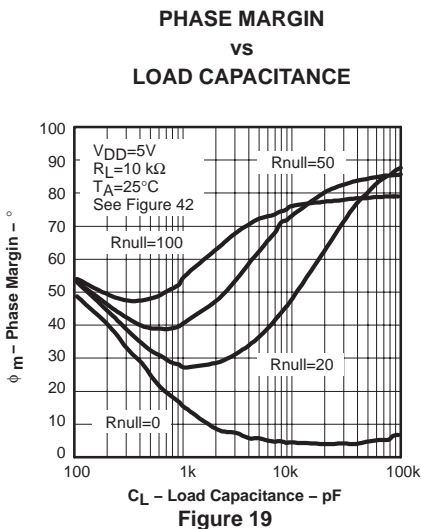
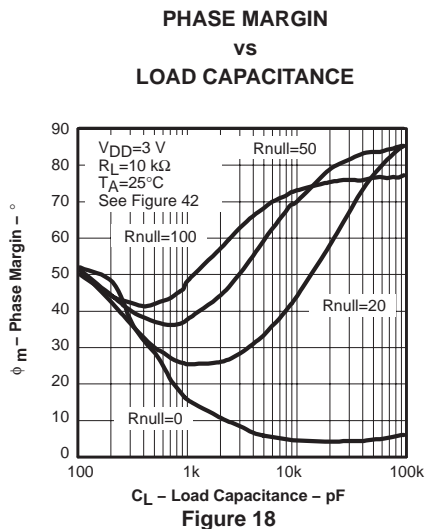

Figure 17

TLV247x-Q1, TLV247xA-Q1 FAMILY OF 600- μ A/Ch 2.8-MHz RAIL-TO-RAIL INPUT/OUTPUT HIGH-DRIVE OPERATIONAL AMPLIFIERS

SGLS180B – AUGUST 2003 – REVISED APRIL 2008

TYPICAL CHARACTERISTICS



TLV247x-Q1, TLV247xA-Q1

FAMILY OF 600- μ A/Ch 2.8-MHz RAIL-TO-RAIL INPUT/OUTPUT HIGH-DRIVE OPERATIONAL AMPLIFIERS

SGLS180B – AUGUST 2003 – REVISED APRIL 2008

TYPICAL CHARACTERISTICS

CROSSTALK
vs
FREQUENCY

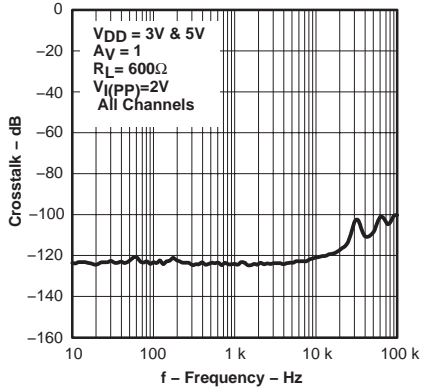

Figure 26

TOTAL HARMONIC DISTORTION PLUS NOISE
vs
FREQUENCY

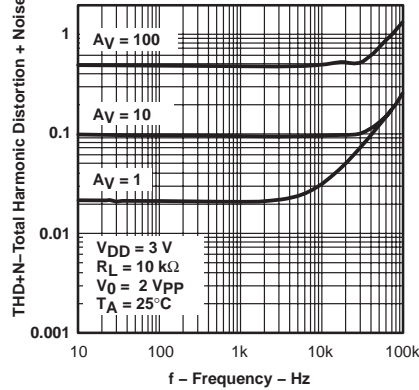

Figure 27

TOTAL HARMONIC DISTORTION PLUS NOISE
vs
FREQUENCY

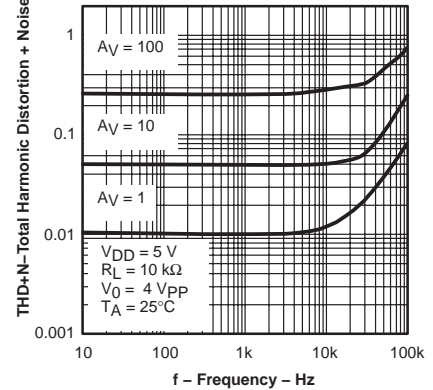

Figure 28

LARGE SIGNAL FOLLOWER
PULSE RESPONSE

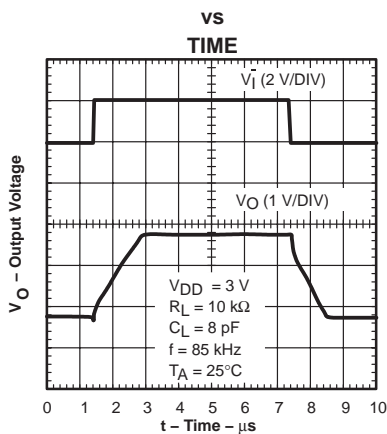

Figure 29

LARGE SIGNAL FOLLOWER
PULSE RESPONSE

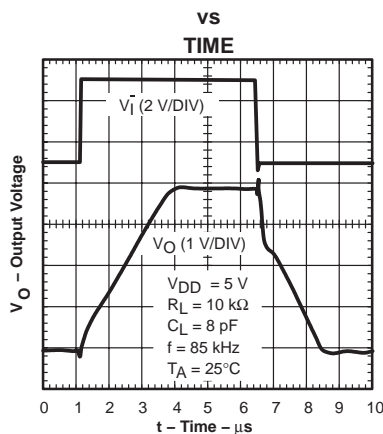

Figure 30

SMALL SIGNAL FOLLOWER
PULSE RESPONSE

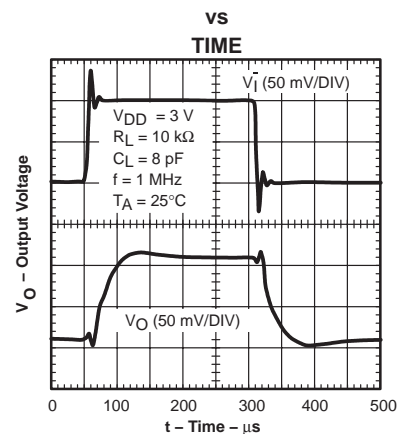

Figure 31

SMALL SIGNAL FOLLOWER
PULSE RESPONSE

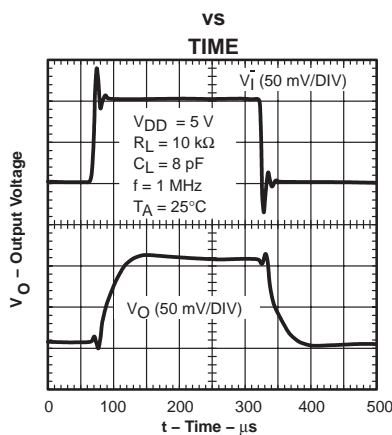

Figure 32



PARAMETER MEASUREMENT INFORMATION

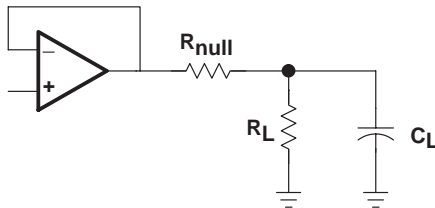

Figure 33

APPLICATION INFORMATION

driving a capacitive load

When the amplifier is configured in this manner, capacitive loading directly on the output decreases the device's phase margin leading to high frequency ringing or oscillations. Therefore, for capacitive loads of greater than 10 pF, it is recommended that a resistor be placed in series (R_{NULL}) with the output of the amplifier, as shown in Figure 34. A minimum value of 20 Ω should work well for most applications.

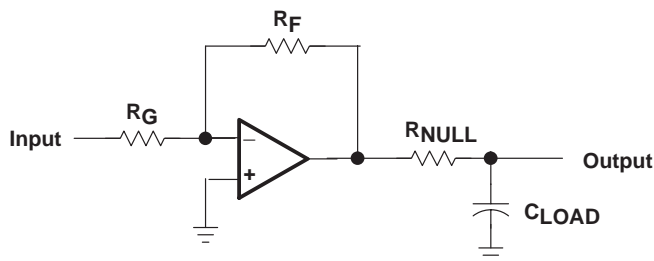

Figure 34. Driving a Capacitive Load

offset voltage

The output offset voltage, (V_{OO}) is the sum of the input offset voltage (V_{IO}) and both input bias currents (I_{IB}) times the corresponding gains. The following schematic and formula can be used to calculate the output offset voltage.

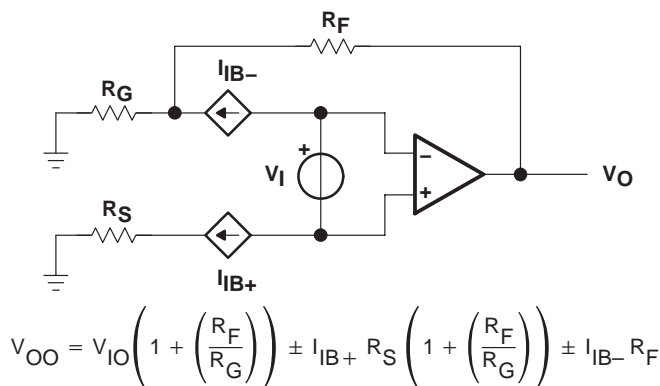

Figure 35. Output Offset Voltage Model

TLV247x-Q1, TLV247xA-Q1
FAMILY OF 600- μ A/Ch 2.8-MHz RAIL-TO-RAIL INPUT/OUTPUT
HIGH-DRIVE OPERATIONAL AMPLIFIERS

SGLS180B – AUGUST 2003 – REVISED APRIL 2008

APPLICATION INFORMATION

general configurations

When receiving low-level signals, limiting the bandwidth of the incoming signals into the system is often required. The simplest way to accomplish this is to place an RC filter at the noninverting terminal of the amplifier (see Figure 36).

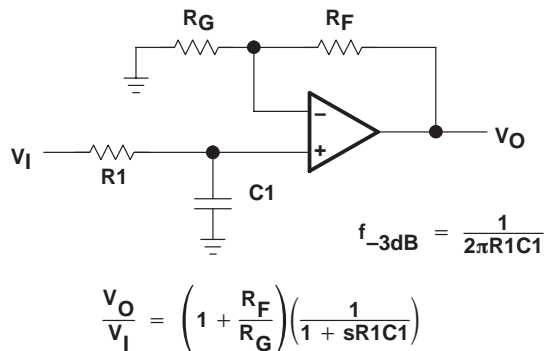

Figure 36. Single-Pole Low-Pass Filter

If even more attenuation is needed, a multiple pole filter is required. The Sallen-Key filter can be used for this task. For best results, the amplifier should have a bandwidth that is 8 to 10 times the filter frequency bandwidth. Failure to do this can result in phase shift of the amplifier.

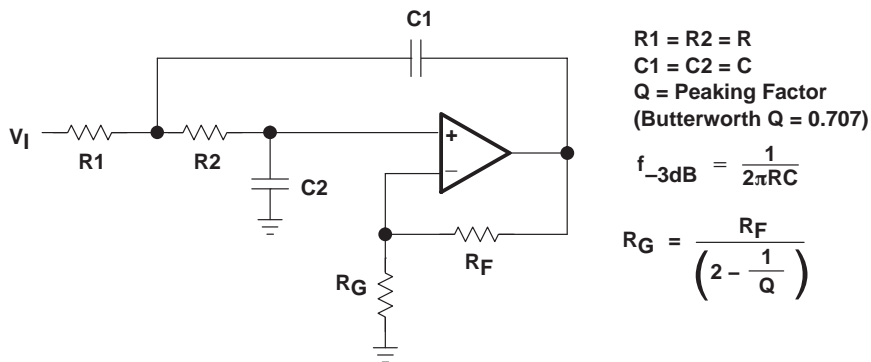

Figure 37. 2-Pole Low-Pass Sallen-Key Filter

APPLICATION INFORMATION

circuit layout considerations

To achieve the levels of high performance of the TLV247x, follow proper printed-circuit board design techniques. A general set of guidelines is given in the following.

- Ground planes – It is highly recommended that a ground plane be used on the board to provide all components with a low inductive ground connection. However, in the areas of the amplifier inputs and output, the ground plane can be removed to minimize the stray capacitance.
- Proper power supply decoupling – Use a 6.8- μ F tantalum capacitor in parallel with a 0.1- μ F ceramic capacitor on each supply terminal. It may be possible to share the tantalum among several amplifiers depending on the application, but a 0.1- μ F ceramic capacitor should always be used on the supply terminal of every amplifier. In addition, the 0.1- μ F capacitor should be placed as close as possible to the supply terminal. As this distance increases, the inductance in the connecting trace makes the capacitor less effective. The designer should strive for distances of less than 0.1 inches between the device power terminals and the ceramic capacitors.
- Sockets – Sockets can be used but are not recommended. The additional lead inductance in the socket pins often leads to stability problems. Surface-mount packages soldered directly to the printed-circuit board is the best implementation.
- Short trace runs/compact part placements – Optimum high performance is achieved when stray series inductance has been minimized. To realize this, the circuit layout should be made as compact as possible, thereby minimizing the length of all trace runs. Particular attention should be paid to the inverting input of the amplifier. Its length should be kept as short as possible. This helps to minimize stray capacitance at the input of the amplifier.
- Surface-mount passive components – Using surface-mount passive components is recommended for high performance amplifier circuits for several reasons. First, because of the extremely low lead inductance of surface-mount components, the problem with stray series inductance is greatly reduced. Second, the small size of surface-mount components naturally leads to a more compact layout thereby minimizing both stray inductance and capacitance. If leaded components are used, it is recommended that the lead lengths be kept as short as possible.

TLV247x-Q1, TLV247xA-Q1
FAMILY OF 600- μ A/Ch 2.8-MHz RAIL-TO-RAIL INPUT/OUTPUT
HIGH-DRIVE OPERATIONAL AMPLIFIERS

SGLS180B – AUGUST 2003 – REVISED APRIL 2008

APPLICATION INFORMATION

general PowerPAD™ design considerations

The TLV247x is available in a thermally-enhanced PowerPAD family of packages. These packages are constructed using a downset leadframe upon which the die is mounted [see Figure 38(a) and Figure 38(b)]. This arrangement results in the lead frame being exposed as a thermal pad on the underside of the package [see Figure 38(c)]. Because this thermal pad has direct thermal contact with the die, excellent thermal performance can be achieved by providing a good thermal path away from the thermal pad.

The PowerPAD package allows for both assembly and thermal management in one manufacturing operation. During the surface-mount solder operation (when the leads are being soldered), the thermal pad can also be soldered to a copper area underneath the package. Through the use of thermal paths within this copper area, heat can be conducted away from the package into either a ground plane or other heat dissipating device.

The PowerPAD package represents a breakthrough in combining the small area and ease of assembly of surface mount with the, heretofore, awkward mechanical methods of heatsinking.

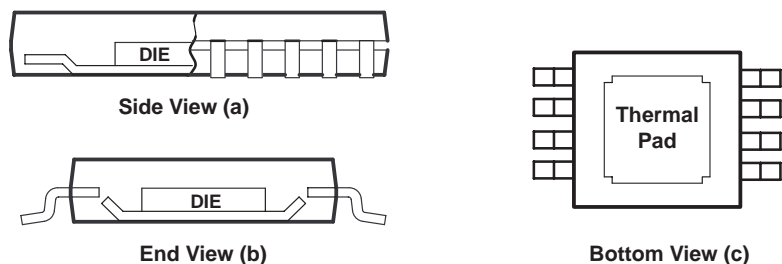

NOTE A: The thermal pad is electrically isolated from all terminals in the package.

Figure 38. Views of Thermally Enhanced DGN Package

Although there are many ways to properly heatsink the PowerPAD package, the following steps illustrate the recommended approach.

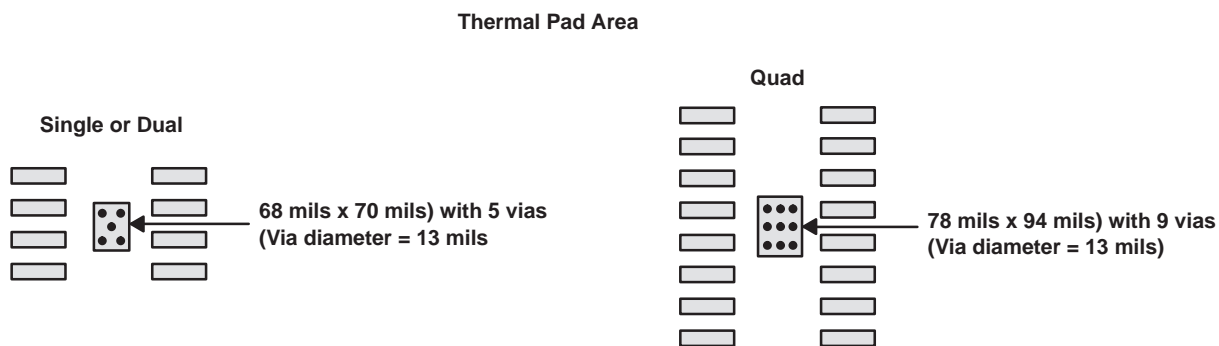

Figure 39. PowerPAD PCB Etch and Via Pattern

PowerPAD is a trademark of Texas Instruments Incorporated.



POST OFFICE BOX 655303 • DALLAS, TEXAS 75265

APPLICATION INFORMATION

general PowerPAD design considerations (continued)

1. Prepare the PCB with a top side etch pattern as shown in Figure 39. There should be etch for the leads as well as etch for the thermal pad.
2. Place five holes (dual) or nine holes (quad) in the area of the thermal pad. These holes should be 13 mils in diameter. Keep them small so that solder wicking through the holes is not a problem during reflow.
3. Additional vias may be placed anywhere along the thermal plane outside of the thermal pad area. This helps dissipate the heat generated by the TLV247x IC. These additional vias may be larger than the 13-mil diameter vias directly under the thermal pad. They can be larger because they are not in the thermal pad area to be soldered so that wicking is not a problem.
4. Connect all holes to the internal ground plane.
5. When connecting these holes to the ground plane, **do not** use the typical web or spoke via connection methodology. Web connections have a high thermal resistance connection that is useful for slowing the heat transfer during soldering operations. This makes the soldering of vias that have plane connections easier. In this application, however, low thermal resistance is desired for the most efficient heat transfer. Therefore, the holes under the TLV247x PowerPAD package should make their connection to the internal ground plane with a complete connection around the entire circumference of the plated-through hole.
6. The top-side solder mask should leave the terminals of the package and the thermal pad area with its five holes (dual) or nine holes (quad) exposed. The bottom-side solder mask should cover the five or nine holes of the thermal pad area. This prevents solder from being pulled away from the thermal pad area during the reflow process.
7. Apply solder paste to the exposed thermal pad area and all of the IC terminals.
8. With these preparatory steps in place, the TLV247x IC is simply placed in position and run through the solder reflow operation as any standard surface-mount component. This results in a part that is properly installed.

For a given θ_{JA} , the maximum power dissipation is shown in Figure 40 and is calculated by the following formula:

$$P_D = \left(\frac{T_{MAX} - T_A}{\theta_{JA}} \right)$$

Where:

P_D = Maximum power dissipation of TLV247x IC (watts)

T_{MAX} = Absolute maximum junction temperature (150°C)

T_A = Free-ambient air temperature (°C)

θ_{JA} = $\theta_{JC} + \theta_{CA}$

θ_{JC} = Thermal coefficient from junction to case

θ_{CA} = Thermal coefficient from case to ambient air (°C/W)

TLV247x-Q1, TLV247xA-Q1
FAMILY OF 600- μ A/Ch 2.8-MHz RAIL-TO-RAIL INPUT/OUTPUT
HIGH-DRIVE OPERATIONAL AMPLIFIERS

SGLS180B – AUGUST 2003 – REVISED APRIL 2008

APPLICATION INFORMATION

general PowerPAD design considerations (continued)

MAXIMUM POWER DISSIPATION
VS
FREE-AIR TEMPERATURE

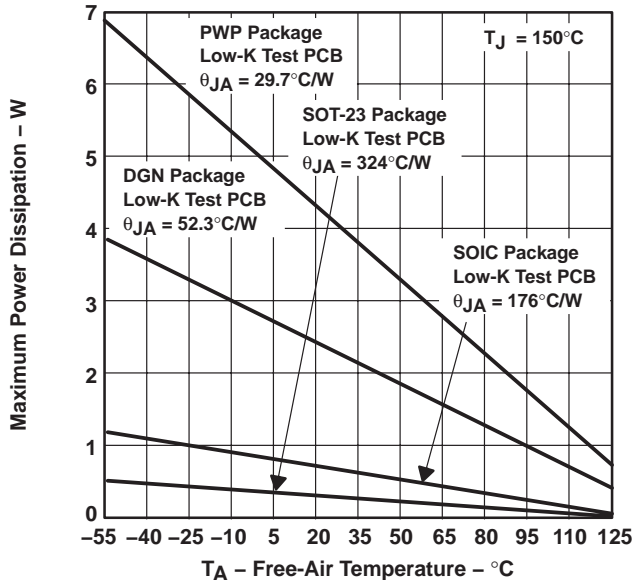

NOTE A: Results are with no air flow and using JEDEC Standard Low-K test PCB.

Figure 40.

The next consideration is the package constraints. The two sources of heat within an amplifier are quiescent power and output power. The designer should never forget about the quiescent heat generated within the device, especially multi-amplifier devices. Because these devices have linear output stages (Class A-B), most of the heat dissipation is at low output voltages with high output currents. Figure 41 to Figure 46 show this effect, along with the quiescent heat, with an ambient air temperature of 70°C and 125°C. When using $V_{DD} = 3\text{ V}$, there is generally not a heat problem with an ambient air temperature of 70°C. But, when using $V_{DD} = 5\text{ V}$, the packages are severely limited in the amount of heat it can dissipate. The other key factor when looking at these graphs is how the devices are mounted on the PCB. The PowerPAD devices are extremely useful for heat dissipation. But, the device should always be soldered to a copper plane to fully use the heat dissipation properties of the PowerPAD. The SOIC package, on the other hand, is highly dependent on how it is mounted on the PCB. As more trace and copper area is placed around the device, θ_{JA} decreases and the heat dissipation capability increases. The currents and voltages shown in these graphs are for the total package. For the dual or quad amplifier packages, the sum of the RMS output currents and voltages should be used to choose the proper package.

TLV247x-Q1, TLV247xA-Q1 FAMILY OF 600- μ A/Ch 2.8-MHz RAIL-TO-RAIL INPUT/OUTPUT HIGH-DRIVE OPERATIONAL AMPLIFIERS

SGLS180B – AUGUST 2003 – REVISED APRIL 2008

APPLICATION INFORMATION

general PowerPAD design considerations (continued)

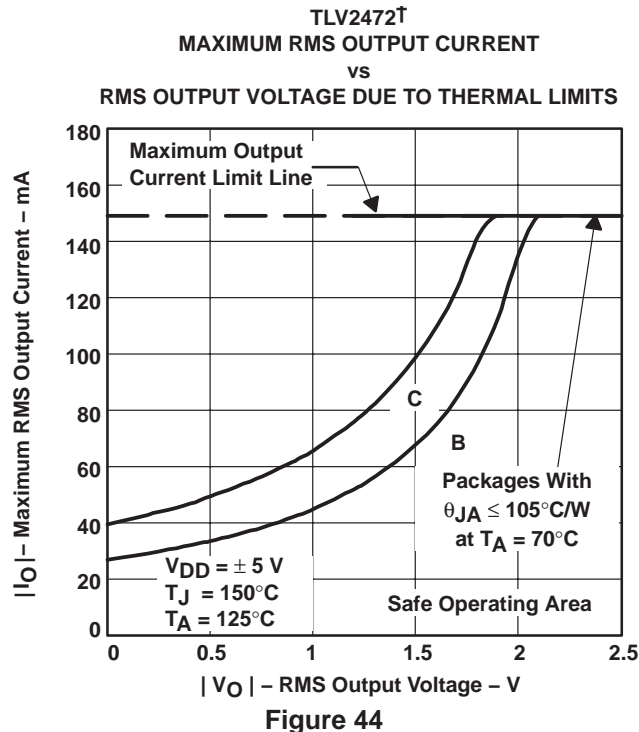
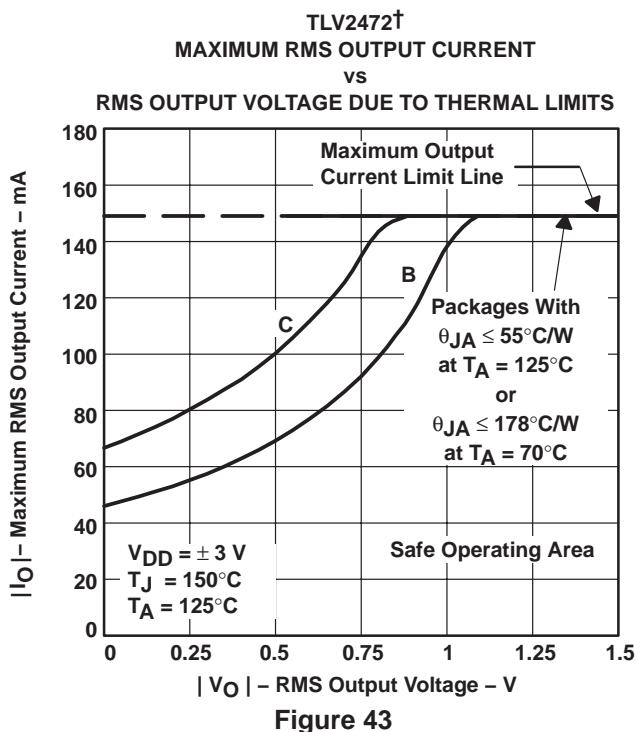
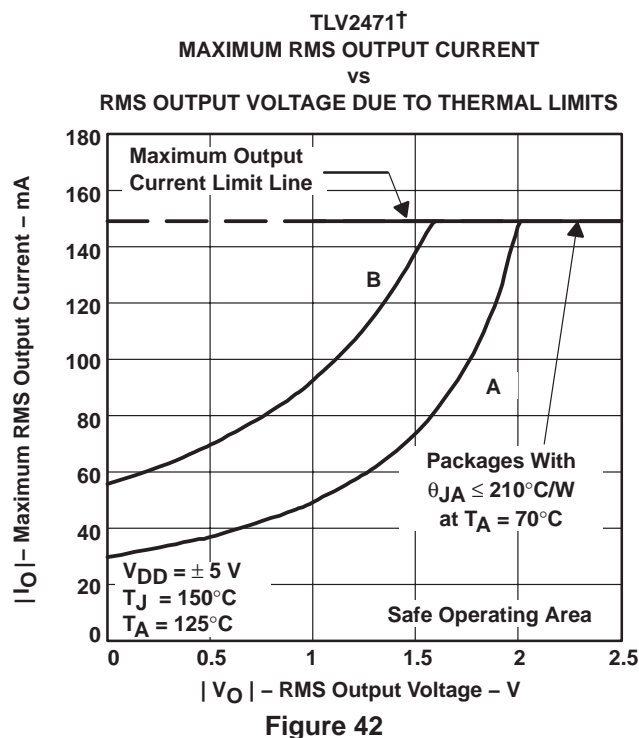
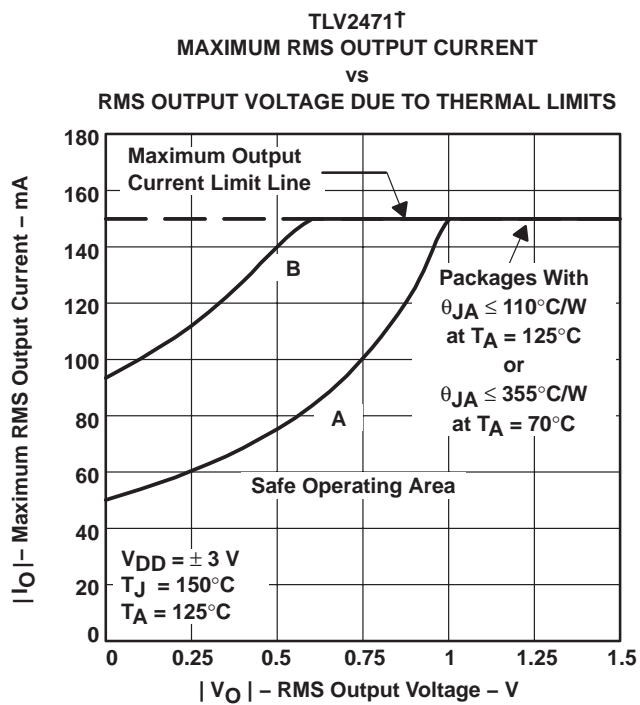

† A – SOT23(5); B – SOIC (8); C – SOIC (14); D – TSSOP PP (14)

TLV247x-Q1, TLV247xA-Q1 FAMILY OF 600- μ A/Ch 2.8-MHz RAIL-TO-RAIL INPUT/OUTPUT HIGH-DRIVE OPERATIONAL AMPLIFIERS

SGLS180B – AUGUST 2003 – REVISED APRIL 2008

APPLICATION INFORMATION

general PowerPAD design considerations (continued)

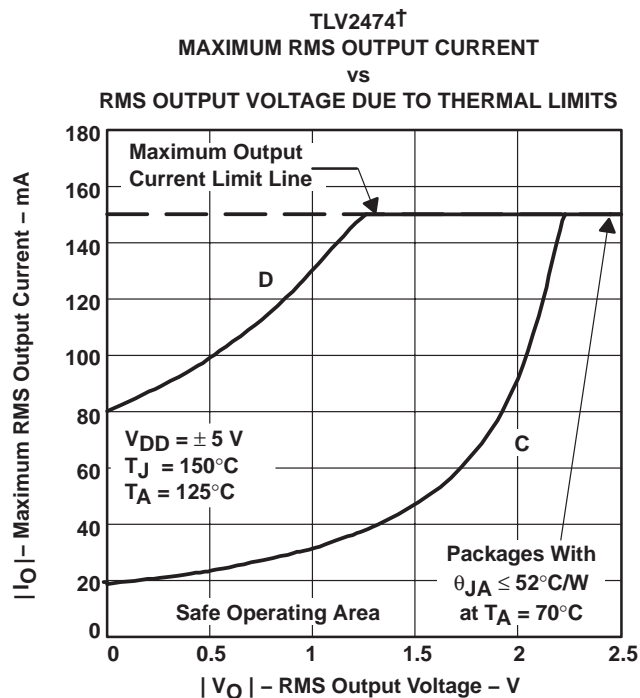
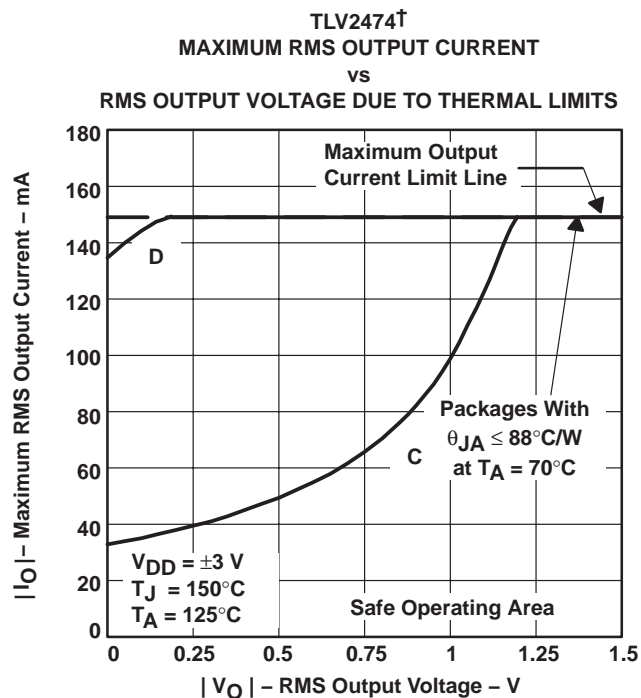

† A – SOT23(5); B – SOIC (8); C – SOIC (14); D – TSSOP PP (14)

TLV247x-Q1, TLV247xA-Q1 FAMILY OF 600- μ A/Ch 2.8-MHz RAIL-TO-RAIL INPUT/OUTPUT HIGH-DRIVE OPERATIONAL AMPLIFIERS

SGLS180B – AUGUST 2003 – REVISED APRIL 2008

APPLICATION INFORMATION

macromodel information

Macromodel information provided was derived using Microsim *Parts*[™], the model generation software used with Microsim *PSpice*[™]. The Boyle macromodel (see Note 1) and subcircuit in Figure 47 are generated using the TLV247x typical electrical and operating characteristics at $T_A = 25^\circ\text{C}$. Using this information, output simulations of the following key parameters can be generated to a tolerance of 20% (in most cases):

- Maximum positive output voltage swing
- Maximum negative output voltage swing
- Slew rate
- Quiescent power dissipation
- Input bias current
- Open-loop voltage amplification
- Unity-gain frequency
- Common-mode rejection ratio
- Phase margin
- DC output resistance
- AC output resistance
- Short-circuit output current limit

NOTE 1: G. R. Boyle, B. M. Cohn, D. O. Pederson, and J. E. Solomon, "Macromodeling of Integrated Circuit Operational Amplifiers," *IEEE Journal of Solid-State Circuits*, SC-9, 353 (1974).

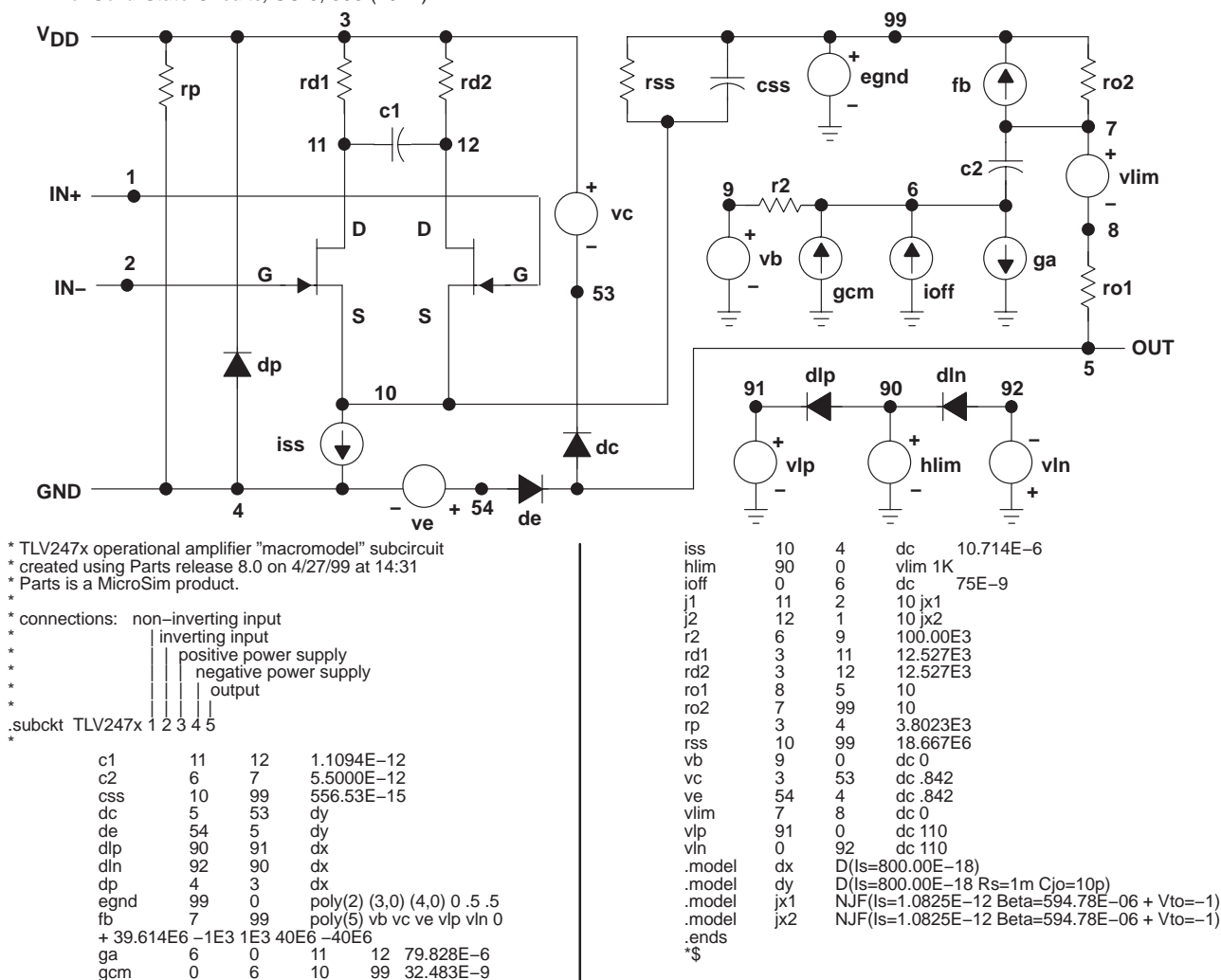

Figure 47. Boyle Macromodel and Subcircuit

PSpice and *Parts* are trademarks of MicroSim Corporation.



PACKAGING INFORMATION

Orderable Device	Status (1)	Package Type	Package Drawing	Pins	Package Qty	Eco Plan (2)	Lead finish/ Ball material (6)	MSL Peak Temp (3)	Op Temp (°C)	Device Marking (4/5)	Samples
TLV2471AQDRG4Q1	ACTIVE	SOIC	D	8	2500	RoHS & Green	NIPDAU	Level-1-260C-UNLIM	-40 to 125	2471AQ	Samples
TLV2471QDBVRQ1	ACTIVE	SOT-23	DBV	5	3000	RoHS & Green	NIPDAU	Level-1-260C-UNLIM	-40 to 125	471Q	Samples
TLV2472AQDRG4Q1	ACTIVE	SOIC	D	8	2500	RoHS & Green	NIPDAU	Level-1-260C-UNLIM	-40 to 125	2472AQ	Samples
TLV2472QDRG4Q1	ACTIVE	SOIC	D	8	2500	RoHS & Green	NIPDAU	Level-1-260C-UNLIM	-40 to 125	2472Q1	Samples
TLV2472QDRQ1	ACTIVE	SOIC	D	8	2500	RoHS & Green	NIPDAU	Level-1-260C-UNLIM	-40 to 125	2472Q1	Samples
TLV2474APWPRQ1	ACTIVE	HTSSOP	PWP	14	2000	RoHS & Green	NIPDAU	Level-2-260C-1 YEAR	-40 to 125	2474AQ1	Samples
TLV2474AQDRG4Q1	ACTIVE	SOIC	D	14	2500	RoHS & Green	NIPDAU	Level-1-260C-UNLIM	-40 to 125	2474AQ1	Samples
TLV2474QDRG4Q1	ACTIVE	SOIC	D	14	2500	RoHS & Green	NIPDAU	Level-1-260C-UNLIM	-40 to 125	2474Q1	Samples
TLV2474QDRQ1	ACTIVE	SOIC	D	14	2500	RoHS & Green	NIPDAU	Level-1-260C-UNLIM	-40 to 125	2474Q1	Samples
TLV2474QPWPRQ1	ACTIVE	HTSSOP	PWP	14	2000	RoHS & Green	NIPDAU	Level-2-260C-1 YEAR	-40 to 125	2474Q1	Samples

(1) The marketing status values are defined as follows:

ACTIVE: Product device recommended for new designs.

LIFEBUY: TI has announced that the device will be discontinued, and a lifetime-buy period is in effect.

NRND: Not recommended for new designs. Device is in production to support existing customers, but TI does not recommend using this part in a new design.

PREVIEW: Device has been announced but is not in production. Samples may or may not be available.

OBSOLETE: TI has discontinued the production of the device.

(2) **RoHS:** TI defines "RoHS" to mean semiconductor products that are compliant with the current EU RoHS requirements for all 10 RoHS substances, including the requirement that RoHS substance do not exceed 0.1% by weight in homogeneous materials. Where designed to be soldered at high temperatures, "RoHS" products are suitable for use in specified lead-free processes. TI may reference these types of products as "Pb-Free".

RoHS Exempt: TI defines "RoHS Exempt" to mean products that contain lead but are compliant with EU RoHS pursuant to a specific EU RoHS exemption.

Green: TI defines "Green" to mean the content of Chlorine (Cl) and Bromine (Br) based flame retardants meet JS709B low halogen requirements of <=1000ppm threshold. Antimony trioxide based flame retardants must also meet the <=1000ppm threshold requirement.

(3) MSL, Peak Temp. - The Moisture Sensitivity Level rating according to the JEDEC industry standard classifications, and peak solder temperature.

(4) There may be additional marking, which relates to the logo, the lot trace code information, or the environmental category on the device.

⁽⁵⁾ Multiple Device Markings will be inside parentheses. Only one Device Marking contained in parentheses and separated by a "~" will appear on a device. If a line is indented then it is a continuation of the previous line and the two combined represent the entire Device Marking for that device.

⁽⁶⁾ Lead finish/Ball material - Orderable Devices may have multiple material finish options. Finish options are separated by a vertical ruled line. Lead finish/Ball material values may wrap to two lines if the finish value exceeds the maximum column width.

Important Information and Disclaimer:The information provided on this page represents TI's knowledge and belief as of the date that it is provided. TI bases its knowledge and belief on information provided by third parties, and makes no representation or warranty as to the accuracy of such information. Efforts are underway to better integrate information from third parties. TI has taken and continues to take reasonable steps to provide representative and accurate information but may not have conducted destructive testing or chemical analysis on incoming materials and chemicals. TI and TI suppliers consider certain information to be proprietary, and thus CAS numbers and other limited information may not be available for release.

In no event shall TI's liability arising out of such information exceed the total purchase price of the TI part(s) at issue in this document sold by TI to Customer on an annual basis.

OTHER QUALIFIED VERSIONS OF TLV2471-Q1, TLV2471A-Q1, TLV2472-Q1, TLV2472A-Q1, TLV2474-Q1, TLV2474A-Q1 :

- Catalog: [TLV2471](#), [TLV2471A](#), [TLV2472](#), [TLV2472A](#), [TLV2474](#), [TLV2474A](#)

NOTE: Qualified Version Definitions:

- Catalog - TI's standard catalog product

TAPE AND REEL INFORMATION

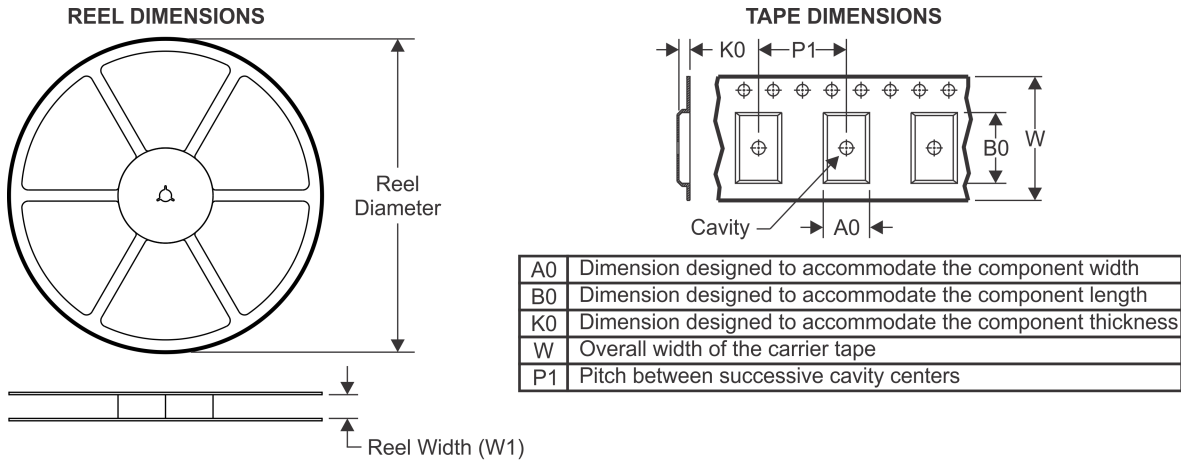

QUADRANT ASSIGNMENTS FOR PIN 1 ORIENTATION IN TAPE



*All dimensions are nominal

Device	Package Type	Package Drawing	Pins	SPQ	Reel Diameter (mm)	Reel Width W1 (mm)	A0 (mm)	B0 (mm)	K0 (mm)	P1 (mm)	W (mm)	Pin1 Quadrant
TLV2471QDBVRQ1	SOT-23	DBV	5	3000	180.0	9.0	3.15	3.2	1.4	4.0	8.0	Q3

TAPE AND REEL BOX DIMENSIONS



*All dimensions are nominal

Device	Package Type	Package Drawing	Pins	SPQ	Length (mm)	Width (mm)	Height (mm)
TLV2471QDBVRQ1	SOT-23	DBV	5	3000	182.0	182.0	20.0

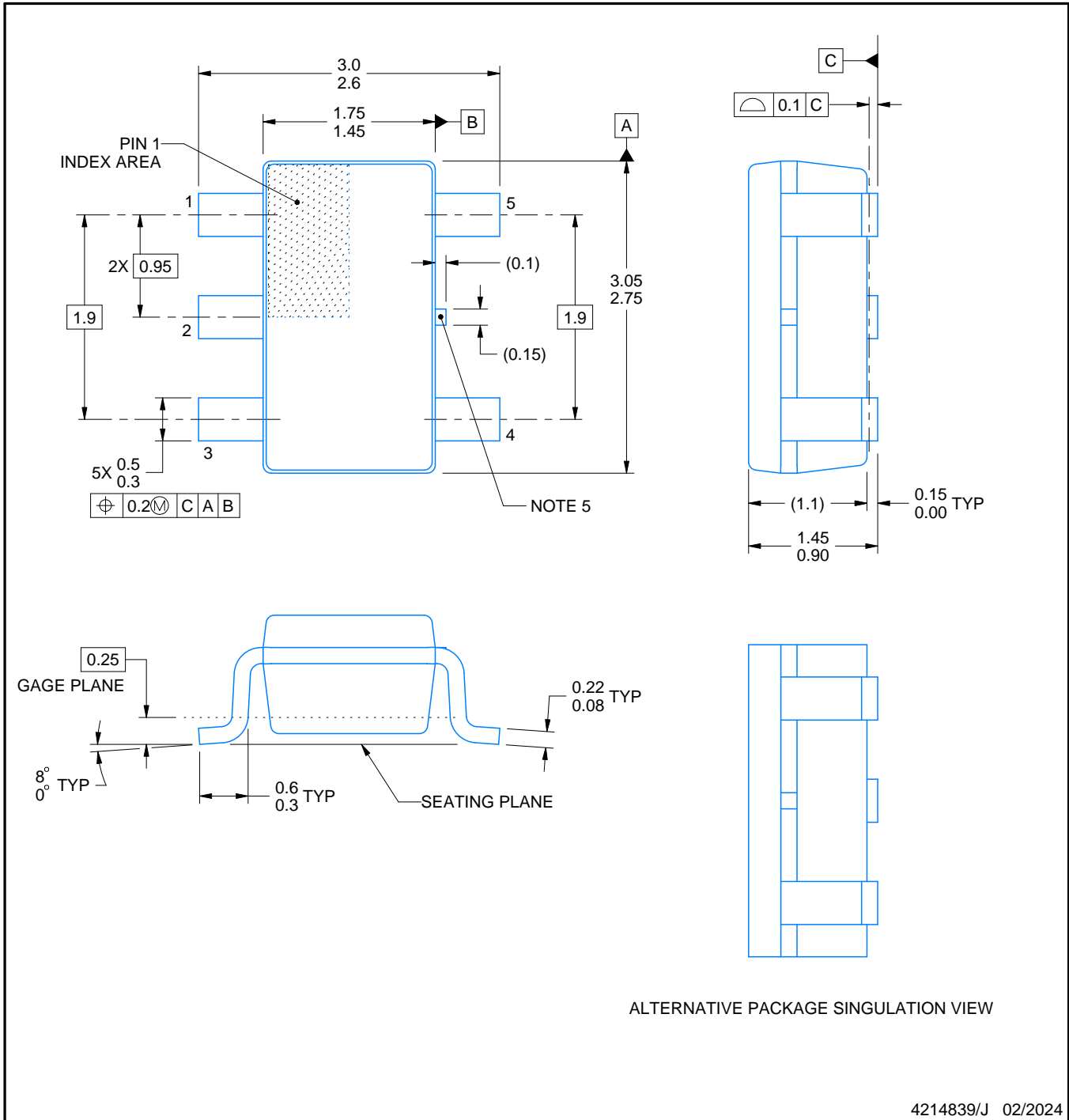

4214839/J 02/2024

NOTES:

1. All linear dimensions are in millimeters. Any dimensions in parenthesis are for reference only. Dimensioning and tolerancing per ASME Y14.5M.
2. This drawing is subject to change without notice.
3. Reference JEDEC MO-178.
4. Body dimensions do not include mold flash, protrusions, or gate burrs. Mold flash, protrusions, or gate burrs shall not exceed 0.25 mm per side.
5. Support pin may differ or may not be present.

EXAMPLE BOARD LAYOUT

DBV0005A

SOT-23 - 1.45 mm max height

SMALL OUTLINE TRANSISTOR



LAND PATTERN EXAMPLE
EXPOSED METAL SHOWN
SCALE:15X



SOLDER MASK DETAILS

4214839/J 02/2024

NOTES: (continued)

- 6. Publication IPC-7351 may have alternate designs.
- 7. Solder mask tolerances between and around signal pads can vary based on board fabrication site.

EXAMPLE STENCIL DESIGN

DBV0005A

SOT-23 - 1.45 mm max height

SMALL OUTLINE TRANSISTOR



SOLDER PASTE EXAMPLE
BASED ON 0.125 mm THICK STENCIL
SCALE:15X

4214839/J 02/2024

NOTES: (continued)

8. Laser cutting apertures with trapezoidal walls and rounded corners may offer better paste release. IPC-7525 may have alternate design recommendations.
9. Board assembly site may have different recommendations for stencil design.

D (R-PDSO-G14)

PLASTIC SMALL OUTLINE



4040047-5/M 06/11

- NOTES:
- A. All linear dimensions are in inches (millimeters).
 - B. This drawing is subject to change without notice.
 -  Body length does not include mold flash, protrusions, or gate burrs. Mold flash, protrusions, or gate burrs shall not exceed 0.006 (0,15) each side.
 -  Body width does not include interlead flash. Interlead flash shall not exceed 0.017 (0,43) each side.
 - E. Reference JEDEC MS-012 variation AB.

D (R-PDSO-G14)

PLASTIC SMALL OUTLINE



4211283-3/E 08/12

- NOTES:
- All linear dimensions are in millimeters.
 - This drawing is subject to change without notice.
 - Publication IPC-7351 is recommended for alternate designs.
 - Laser cutting apertures with trapezoidal walls and also rounding corners will offer better paste release. Customers should contact their board assembly site for stencil design recommendations. Refer to IPC-7525 for other stencil recommendations.
 - Customers should contact their board fabrication site for solder mask tolerances between and around signal pads.

GENERIC PACKAGE VIEW

PWP 14

PowerPAD TSSOP - 1.2 mm max height

4.4 x 5.0, 0.65 mm pitch

PLASTIC SMALL OUTLINE

This image is a representation of the package family, actual package may vary.
Refer to the product data sheet for package details.

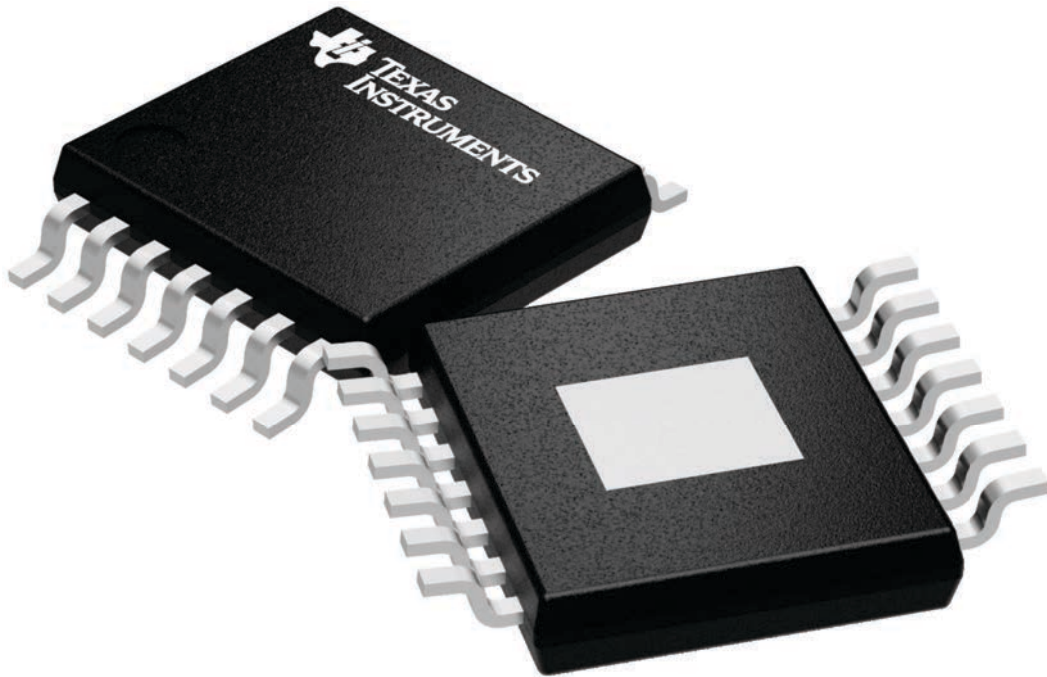

4224995/A

PWP (R-PDSO-G14)

PowerPAD™ PLASTIC SMALL OUTLINE

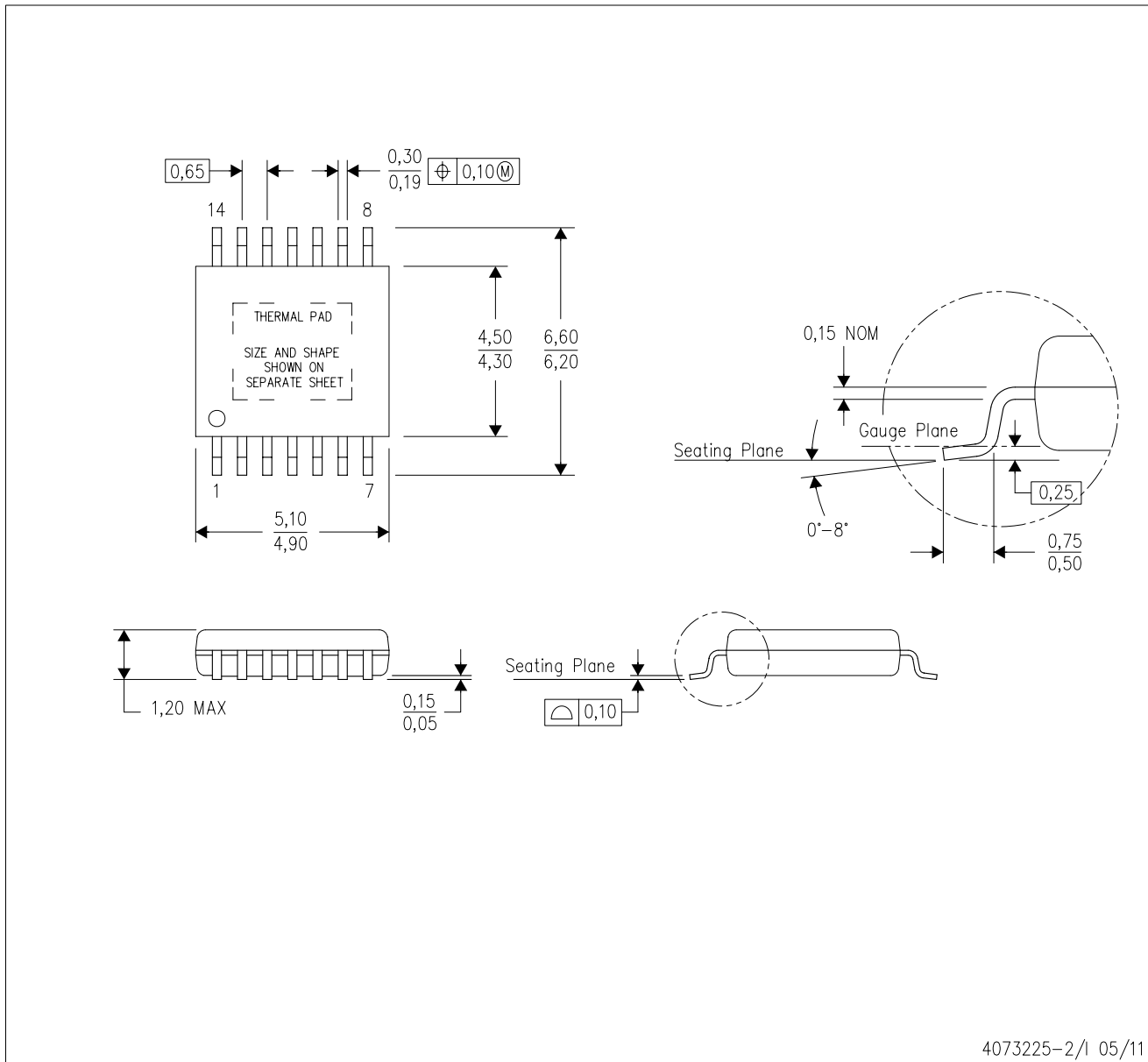

4073225-2/1 05/11

- NOTES:
- All linear dimensions are in millimeters.
 - This drawing is subject to change without notice.
 - Body dimensions do not include mold flash or protrusions. Mold flash and protrusion shall not exceed 0.15 per side.
 - This package is designed to be soldered to a thermal pad on the board. Refer to Technical Brief, PowerPad Thermally Enhanced Package, Texas Instruments Literature No. SLMA002 for information regarding recommended board layout. This document is available at www.ti.com <<http://www.ti.com>>.
 - See the additional figure in the Product Data Sheet for details regarding the exposed thermal pad features and dimensions.
 - Falls within JEDEC MO-153

PowerPAD is a trademark of Texas Instruments.

PWP (R-PDSO-G14) PowerPAD™ SMALL PLASTIC OUTLINE

THERMAL INFORMATION

This PowerPAD™ package incorporates an exposed thermal pad that is designed to be attached to a printed circuit board (PCB). The thermal pad must be soldered directly to the PCB. After soldering, the PCB can be used as a heatsink. In addition, through the use of thermal vias, the thermal pad can be attached directly to the appropriate copper plane shown in the electrical schematic for the device, or alternatively, can be attached to a special heatsink structure designed into the PCB. This design optimizes the heat transfer from the integrated circuit (IC).

For additional information on the PowerPAD package and how to take advantage of its heat dissipating abilities, refer to Technical Brief, PowerPAD Thermally Enhanced Package, Texas Instruments Literature No. SLMA002 and Application Brief, PowerPAD Made Easy, Texas Instruments Literature No. SLMA004. Both documents are available at www.ti.com.

The exposed thermal pad dimensions for this package are shown in the following illustration.

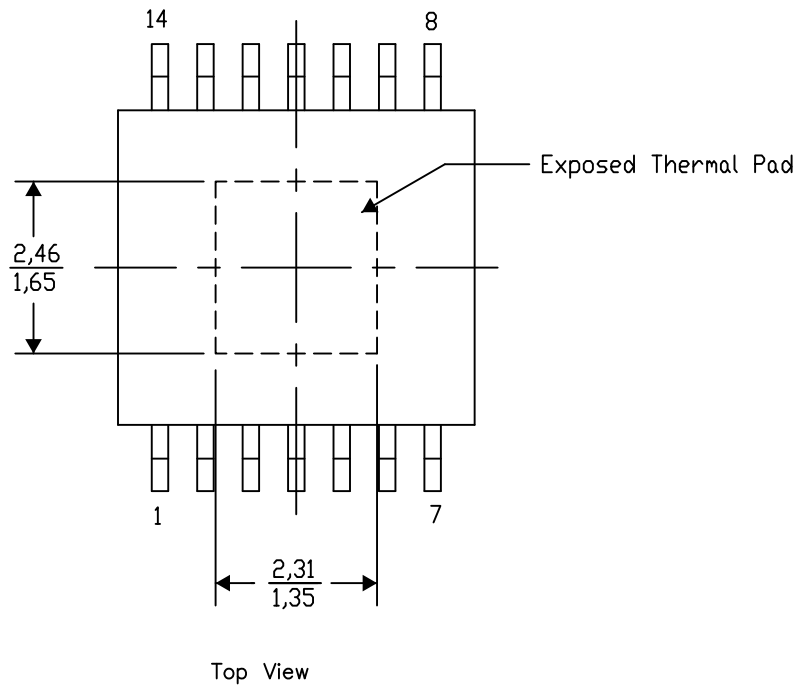

Exposed Thermal Pad Dimensions

4206332-2/AO 01/16

NOTE: A. All linear dimensions are in millimeters

PowerPAD is a trademark of Texas Instruments

PWP (R-PDSO-G14)

PowerPAD™ PLASTIC SMALL OUTLINE

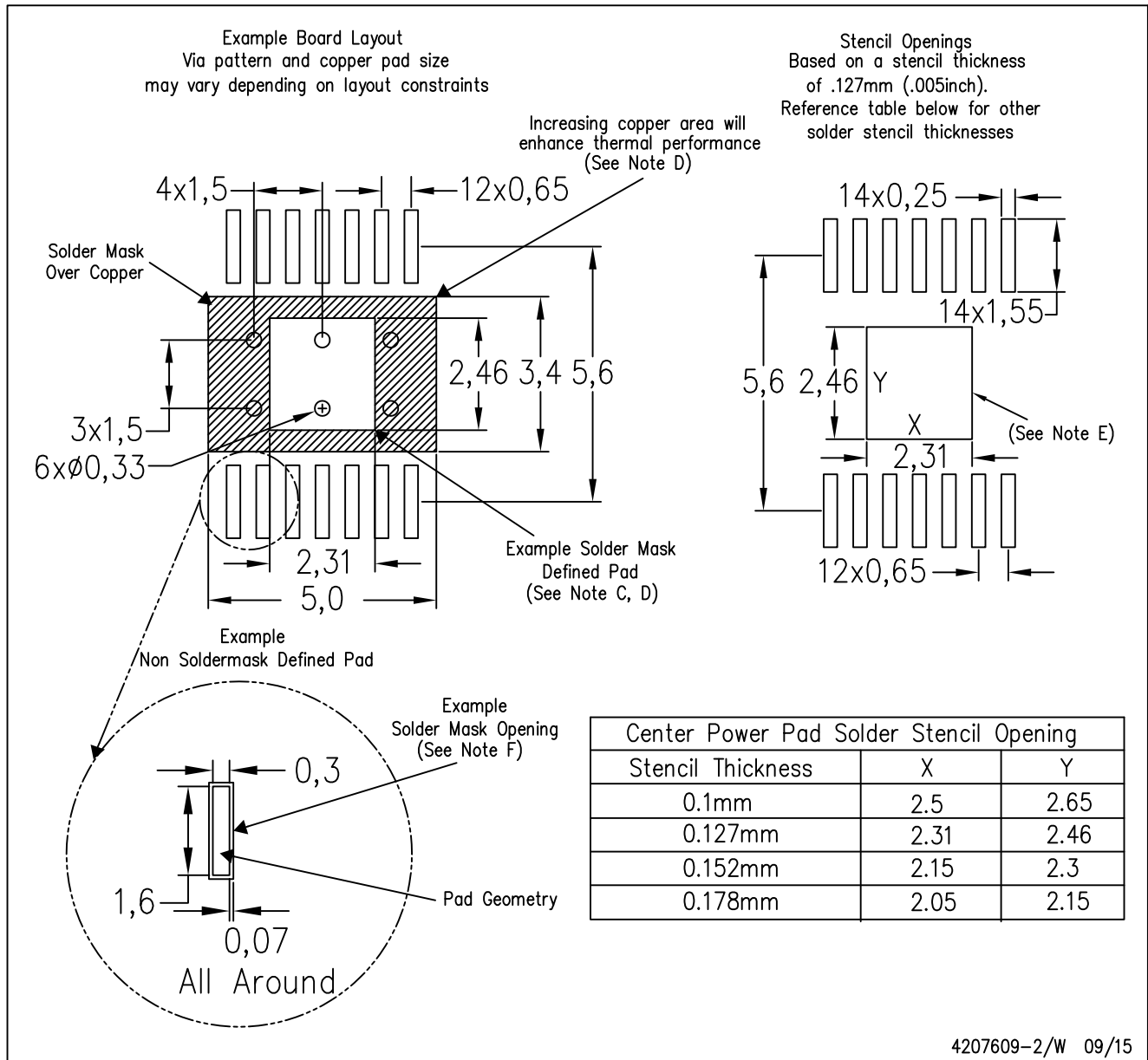

- NOTES:
- A. All linear dimensions are in millimeters.
 - B. This drawing is subject to change without notice.
 - C. Customers should place a note on the circuit board fabrication drawing not to alter the center solder mask defined pad.
 - D. This package is designed to be soldered to a thermal pad on the board. Refer to Technical Brief, PowerPAD Thermally Enhanced Package, Texas Instruments Literature No. SLMA002, SLMA004, and also the Product Data Sheets for specific thermal information, via requirements, and recommended board layout. These documents are available at www.ti.com <<http://www.ti.com>>. Publication IPC-7351 is recommended for alternate designs.
 - E. Laser cutting apertures with trapezoidal walls and also rounding corners will offer better paste release. Customers should contact their board assembly site for stencil design recommendations. Example stencil design based on a 50% volumetric metal load solder paste. Refer to IPC-7525 for other stencil recommendations.
 - F. Customers should contact their board fabrication site for solder mask tolerances between and around signal pads.



D0008A

PACKAGE OUTLINE

SOIC - 1.75 mm max height

SMALL OUTLINE INTEGRATED CIRCUIT



NOTES:

1. Linear dimensions are in inches [millimeters]. Dimensions in parenthesis are for reference only. Controlling dimensions are in inches. Dimensioning and tolerancing per ASME Y14.5M.
2. This drawing is subject to change without notice.
3. This dimension does not include mold flash, protrusions, or gate burrs. Mold flash, protrusions, or gate burrs shall not exceed $.006$ [0.15] per side.
4. This dimension does not include interlead flash.
5. Reference JEDEC registration MS-012, variation AA.

EXAMPLE BOARD LAYOUT

D0008A

SOIC - 1.75 mm max height

SMALL OUTLINE INTEGRATED CIRCUIT



LAND PATTERN EXAMPLE
 EXPOSED METAL SHOWN
 SCALE:8X



SOLDER MASK DETAILS

4214825/C 02/2019

NOTES: (continued)

- 6. Publication IPC-7351 may have alternate designs.
- 7. Solder mask tolerances between and around signal pads can vary based on board fabrication site.

EXAMPLE STENCIL DESIGN

D0008A

SOIC - 1.75 mm max height

SMALL OUTLINE INTEGRATED CIRCUIT



SOLDER PASTE EXAMPLE
BASED ON .005 INCH [0.125 MM] THICK STENCIL
SCALE:8X

4214825/C 02/2019

NOTES: (continued)

8. Laser cutting apertures with trapezoidal walls and rounded corners may offer better paste release. IPC-7525 may have alternate design recommendations.
9. Board assembly site may have different recommendations for stencil design.

IMPORTANT NOTICE AND DISCLAIMER

TI PROVIDES TECHNICAL AND RELIABILITY DATA (INCLUDING DATA SHEETS), DESIGN RESOURCES (INCLUDING REFERENCE DESIGNS), APPLICATION OR OTHER DESIGN ADVICE, WEB TOOLS, SAFETY INFORMATION, AND OTHER RESOURCES "AS IS" AND WITH ALL FAULTS, AND DISCLAIMS ALL WARRANTIES, EXPRESS AND IMPLIED, INCLUDING WITHOUT LIMITATION ANY IMPLIED WARRANTIES OF MERCHANTABILITY, FITNESS FOR A PARTICULAR PURPOSE OR NON-INFRINGEMENT OF THIRD PARTY INTELLECTUAL PROPERTY RIGHTS.

These resources are intended for skilled developers designing with TI products. You are solely responsible for (1) selecting the appropriate TI products for your application, (2) designing, validating and testing your application, and (3) ensuring your application meets applicable standards, and any other safety, security, regulatory or other requirements.

These resources are subject to change without notice. TI grants you permission to use these resources only for development of an application that uses the TI products described in the resource. Other reproduction and display of these resources is prohibited. No license is granted to any other TI intellectual property right or to any third party intellectual property right. TI disclaims responsibility for, and you will fully indemnify TI and its representatives against, any claims, damages, costs, losses, and liabilities arising out of your use of these resources.

TI's products are provided subject to [TI's Terms of Sale](#) or other applicable terms available either on [ti.com](https://www.ti.com) or provided in conjunction with such TI products. TI's provision of these resources does not expand or otherwise alter TI's applicable warranties or warranty disclaimers for TI products.

TI objects to and rejects any additional or different terms you may have proposed.

Mailing Address: Texas Instruments, Post Office Box 655303, Dallas, Texas 75265
Copyright © 2024, Texas Instruments Incorporated