



3-W STEREO CLASS-D AUDIO POWER AMPLIFIER WITH DC VOLUME CONTROL

FEATURES

- **3 W Per Channel into 3-Ω Speakers (THD+N = 10%)**
 - < 0.045% THD at 1.5 W, 1 kHz, 3-Ω Load
- **DC Volume Control With 2-dB Steps From -38 dB to 20 dB**
- **Filter Free Modulation Scheme Operates Without a Large and Expensive LC Output Filter**
- **Extremely Efficient Third Generation 5-V Class-D Technology**
 - Low Supply Current, 7 mA
 - Low Shutdown Control, 1 μA
 - Low Noise Floor, -80 dBV
 - Maximum Efficiency into 3 Ω, 78%
 - Maximum Efficiency into 8 Ω, 88%
 - PSRR, -70 dB
- **Integrated Depop Circuitry**
- **Operating Temperature Range, -40°C to 85°C**
- **Space-Saving, Surface Mount PowerPAD™ Package**

APPLICATIONS

- **LCD Projectors**
- **LCD Monitors**
- **Powered Speakers**
- **Battery Operated and Space Constrained Systems**

DESCRIPTION

The TPA2008D2 is a third generation 5-V class-D amplifier from Texas Instruments. Improvements to previous generation devices include: dc volume control, lower supply current, lower noise floor, higher efficiency, smaller packaging, and fewer external components. Most notably, a new filter-free class-D modulation technique allows the TPA2008D2 to directly drive the speakers, without needing a low-pass output filter consisting of two inductors and three capacitors per channel. Eliminating this output filter saves approximately 30% in system cost and 75% in PCB area.

The improvements and functionality make this device ideal for LCD projectors, LCD monitors, powered speakers, and other applications that demand more battery life, reduced board space, and functionality that surpasses currently available class-D devices.

A chip-level shutdown control limits total supply current to 1 μA, making the device ideal for battery-powered applications. Protection circuitry increases device reliability: thermal and short circuit. Undervoltage shutdown saves battery power for more essential devices when battery voltage drops to low levels.

The TPA2008D2 is available in a 24-pin TSSOP PowerPAD™ package.

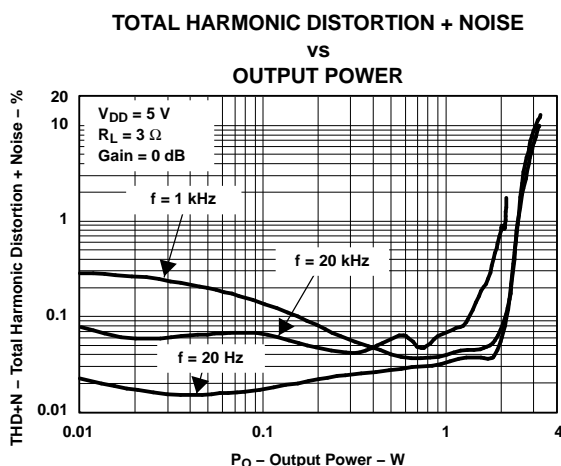
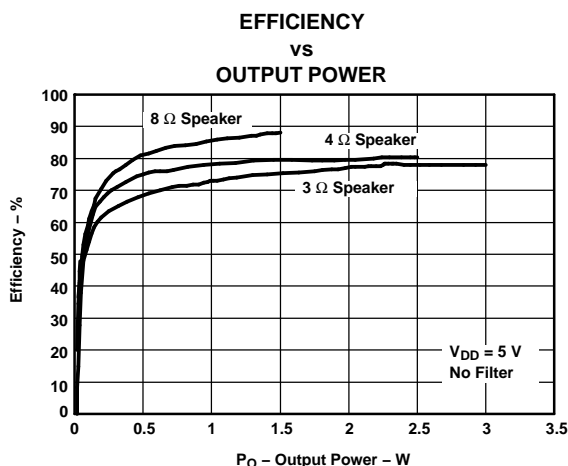

Please be aware that an important notice concerning availability, standard warranty, and use in critical applications of Texas Instruments semiconductor products and disclaimers thereto appears at the end of this data sheet.

PowerPAD is a trademark of Texas Instruments.



These devices have limited built-in ESD protection. The leads should be shorted together or the device placed in conductive foam during storage or handling to prevent electrostatic damage to the MOS gates.

AVAILABLE OPTIONS

	TSSOP PowerPAD (PWP) ⁽¹⁾
Device	TPA2008D2PWP ⁽¹⁾
Package Designator	PWP ⁽¹⁾

(1) The PWP package is available taped and reeled. To order a taped and reeled part, add the suffix R to the part number (e.g., TPA2008D2PWPR).

**PWP PACKAGE
(TOP VIEW)**

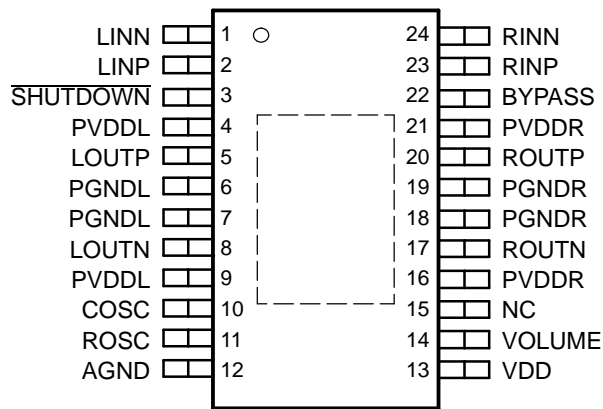

TERMINAL FUNCTIONS

TERMINAL NO.	NAME	I/O	DESCRIPTION
AGND	12	-	Analog ground
BYPASS	22	I	Tap to voltage divider for internal mid-supply bias generator used for internal analog reference.
COSC	10	I	A capacitor connected to this terminal sets the oscillation frequency in conjunction with ROOSC. For proper operation, connect a 220-pF capacitor from COSC to ground.
LINN	1	I	Negative differential audio input for left channel
LINP	2	I	Positive differential audio input for left channel
LOUTN	8	O	Negative audio output for left channel
LOUTP	5	O	Positive audio output for left channel
NC	15	I	No connection
PGNDL	6, 7	-	Power ground for left channel H-bridge
PGNDR	18, 19	-	Power ground for right channel H-bridge
PVDDL	4, 9		Power supply for left channel H-bridge
PVDDR	16, 21		Power supply for right channel H-bridge
RINN	24	I	Positive differential audio input for right channel
RINP	23	I	Negative differential audio input for right channel
ROSC	11	I	A resistor connected to the ROOSC terminal sets the oscillation frequency in conjunction with COSC. For proper operation, connect a 120-k Ω resistor from ROOSC to ground.
ROUTN	17	O	Negative output for right channel
ROUTP	20	O	Positive output for right channel
SHUTDOWN	3	I	Places the amplifier in shutdown mode if a TTL logic low is placed on this terminal; normal operation if a TTL logic high is placed on this terminal.
VDD	13	-	Analog power supply
VOLUME	14	I	DC volume control for setting the gain on the internal amplifiers. The dc voltage range is 0 to VDD.
Thermal Pad	-	-	Connect to analog ground and the power grounds must be soldered down in all applications to properly secure device on the PCB.

FUNCTIONAL BLOCK DIAGRAM

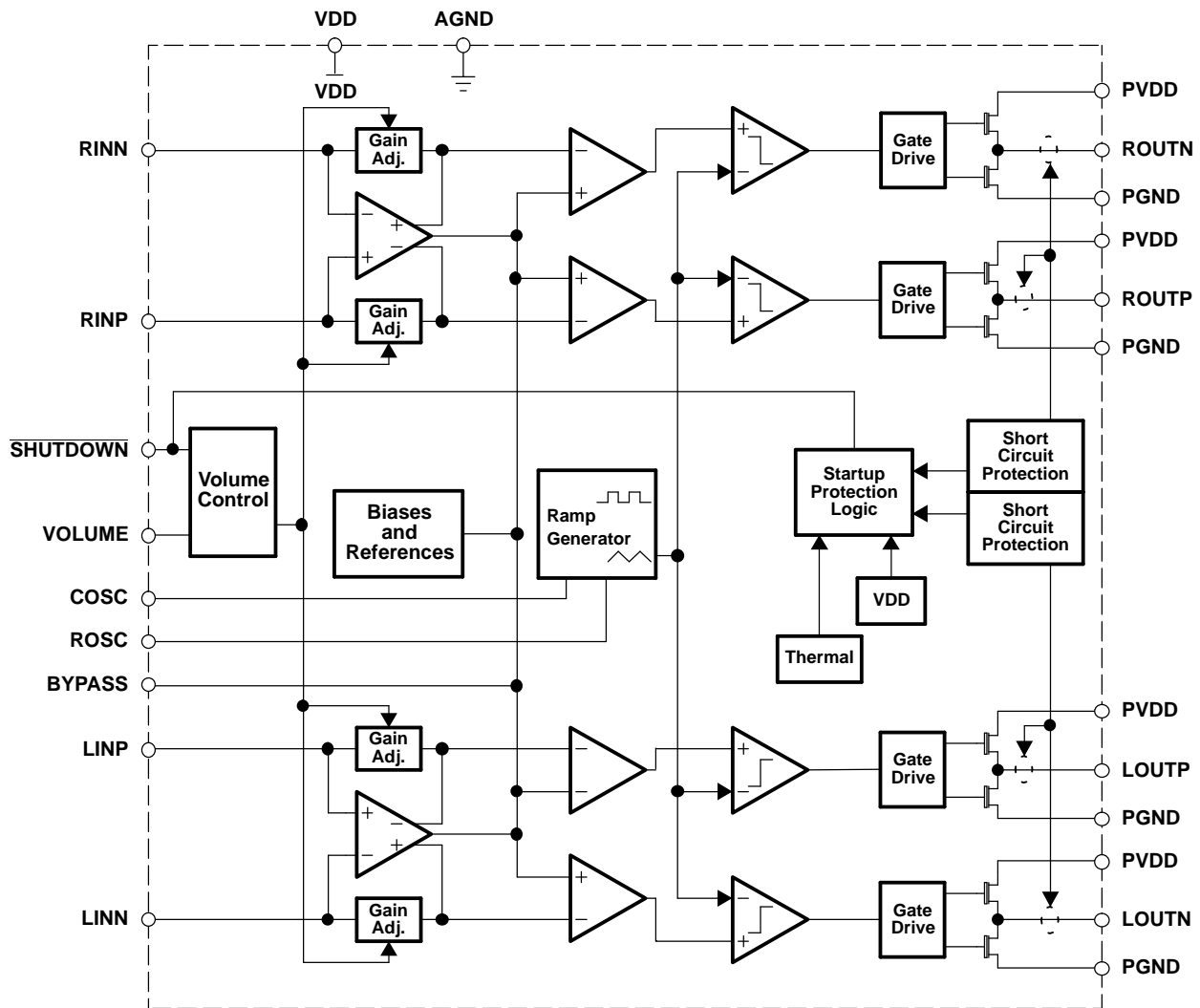

ABSOLUTE MAXIMUM RATINGS

over operating free-air temperature range unless otherwise noted ⁽¹⁾

		UNIT
V_{DD}, PV_{DD}	Supply voltage range	-0.3 V to 6 V
V_I (RINN, RINP, LINN, LINP, VOLUME)	Input voltage range	0 V to V_{DD}
	Continuous total power dissipation	See Dissipation Rating Table
T_A	Operating free-air temperature range	-40°C to 85°C
T_J	Operating junction temperature range	-40°C to 150°C
T_{stg}	Storage temperature range	-65°C to 85°C
	Lead temperature 1,6 mm (1/16 inch) from case for 10 seconds	260°C

(1) Stresses beyond those listed under absolute maximum ratings may cause permanent damage to the device. These are stress ratings only, and functional operation of the device at these or any other conditions beyond those indicated under recommended operating conditions is not implied. Exposure to absolute-maximum-rated conditions for extended periods may affect device reliability.

DISSIPATION RATINGS TABLE

PACKAGE	$T_A \leq 25^\circ\text{C}$	DERATING FACTOR	$T_A = 70^\circ\text{C}$	$T_A = 85^\circ\text{C}$
PWP	2.18 W	21.8 mW/°C	1.2 W	872 mW

RECOMMENDED OPERATING CONDITIONS

		MIN	MAX	UNIT
V_{DD}	Supply voltage	4.5	5.5	V
	Volume terminal voltage	0	V_{DD}	V
V_{IH}	High-level input voltage	SHUTDOWN		V
V_{IL}	Low-level input voltage	SHUTDOWN		V
	PWM frequency	200	300	kHz
T_A	Operating free-air temperature	-40	85	°C
T_J	Operating junction temperature		125	°C

ELECTRICAL CHARACTERISTICS

$T_A = 25^\circ\text{C}$, $V_{DD} = PV_{DD} = 5\text{ V}$ (unless otherwise noted)

PARAMETER	TEST CONDITIONS	MIN	TYP	MAX	UNIT
$ V_{OS} $	Output offset voltage (measured differentially) $V_I = 0\text{ V}$, $A_V = 20\text{ dB}$, $R_L = 8\Omega$		5	25	mV
PSRR	Power supply rejection ratio $V_{DD} = PV_{DD} = 4.5\text{ V to }5.5\text{ V}$		-70		dB
$ I_{IH} $	High-level input current $V_{DD} = PV_{DD} = 5.5\text{ V}$, $V_I = V_{DD} = PV_{DD}$			1	μA
$ I_{IL} $	Low-level input current $V_{DD} = PV_{DD} = 5.5\text{ V}$, $V_I = 0\text{ V}$			1	μA
I_{DD}	Supply current No filter (no load)		7	15	mA
$I_{DD(max)}$	RMS supply current at max power $R_L = 3\Omega$, $P_O = 2.5\text{ W/channel (stereo)}$		1.8		A
$I_{DD(SD)}$	Supply current in shutdown mode SHUTDOWN = 0 V		50	1000	nA
$r_{ds(on)}$	Drain-source on-state resistance $V_{DD} = 5\text{ V}$, $I_O = 500\text{ mA}$, $T_J = 25^\circ\text{C}$				m Ω
	High side		450	600	
	Low side		450	600	

OPERATING CHARACTERISTICS

$T_A = 25^\circ\text{C}$, $V_{DD} = PV_{DD} = 5\text{ V}$, $R_L = 3\Omega$, Gain = 0 dB (unless otherwise noted)

PARAMETER	TEST CONDITIONS	MIN	TYP	MAX	UNITS
P_O	Output power $f = 1\text{ kHz}$, $R_L = 3\Omega$, Stereo operation				W
	THD+N = 1%		2.5		
	THD+N = 10%		3		
THD+N	Total harmonic distortion plus noise $P_O = 2.2\text{ W}$, $f = 20\text{ Hz to }20\text{ kHz}$		<0.3%		
	$P_O = 1.5\text{ W}$, $f = 1\text{ kHz}$		0.045%		
BOM	Maximum output power bandwidth THD = 5%		20		kHz
SNR	Signal-to-noise ratio Maximum output at THD+N <0.5%		96		dB
	Thermal trip point		150		°C
	Thermal hysteresis		20		°C
V_n	Integrated noise floor 20 Hz to 20 kHz, inputs ac grounded				μV_{rms}
	Volume = 0 dB		42		
	Volume = 20 dB		85		

Table 1. TYPICAL DC VOLUME CONTROL

VOLTAGE ON VOLUME PIN (V) (INCREASING OR FIXED GAIN)	VOLTAGE ON VOLUME PIN (V) (DECREASING GAIN)	TYPICAL GAIN OF AMPLIFIER (dB) ⁽¹⁾
0-0.33	0.31-0	-38 ⁽²⁾
0.34-0.42	0.43-0.32	-37
0.43-0.52	0.54-0.44	-35
0.53-0.63	0.64-0.55	-33
0.64-0.75	0.75-0.65	-31
0.76-0.86	0.86-0.76	-29
0.87-0.97	0.97-0.87	-27
0.98-1.07	1.08-0.98	-25
1.08-1.18	1.19-1.09	-23
1.19-1.30	1.32-1.20	-21
1.31-1.41	1.42-1.33	-19
1.42-1.52	1.53-1.43	-17
1.53-1.63	1.63-1.54	-15
1.64-1.75	1.75-1.64	-13
1.76-1.85	1.84-1.76	-12
1.86-1.96	1.96-1.85	-10
1.97-2.07	2.09-1.97	-8
2.08-2.18	2.19-2.10	-6
2.19-2.30	2.33-2.20	-4
2.31-2.40	2.43-2.34	-2
2.41-2.52	2.49-2.44	0 ⁽²⁾
2.53-2.63	2.62-2.50	2
2.64-2.75	2.75-2.63	4
2.76-2.87	2.85-2.76	6
2.88-2.98	2.99-2.86	8
2.99-3.10	3.12-3.00	10
3.11-3.22	3.25-3.13	12
3.23-3.33	3.36-3.26	14
3.34-3.47	3.48-3.37	16
3.48-3.69	3.64-3.49	18
3.70-V _{DD}	V _{DD} -3.65	20 ⁽²⁾

(1) The typical part-to-part gain variation can be as large as ± 2 dB (one gain step).

(2) Tested in production.

The volume control circuitry of the TPA2008D2 is internally referenced to the VDD and AGND terminals. Any common-mode noise between the VOLUME terminal and these terminals will be sensed by the volume control circuitry. If the noise exceeds the step size voltage, the gain will change. In order to minimize this effect, care must be taken to ensure the signal driving the VOLUME terminal is referenced to the VDD and AGND terminals of the TPA2008D2. See section titled, "Special Layout Considerations" for more details.

TYPICAL CHARACTERISTICS

TABLE OF GRAPHS

		FIGURE
Efficiency	vs Output power	1, 2
THD+N Total harmonic distortion + noise	vs Frequency	3-5
	vs Output power	6-8
k_{SVR} Supply ripple rejection ratio	vs Frequency	9
Crosstalk	vs Frequency	10
CMRR Common-mode rejection ratio	vs Frequency	11
R_i Input resistance	vs Gain setting	12

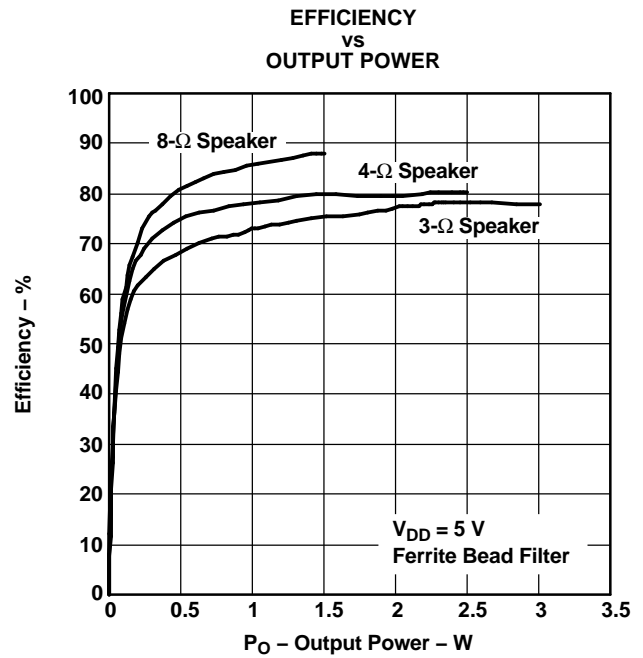
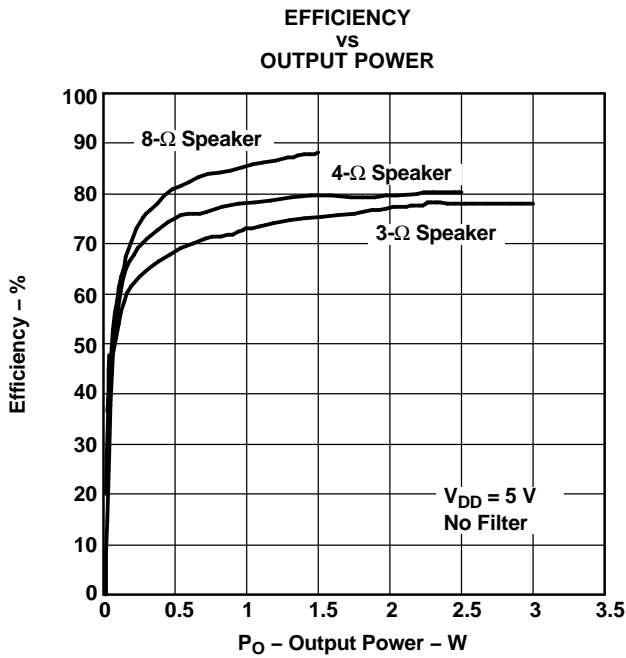

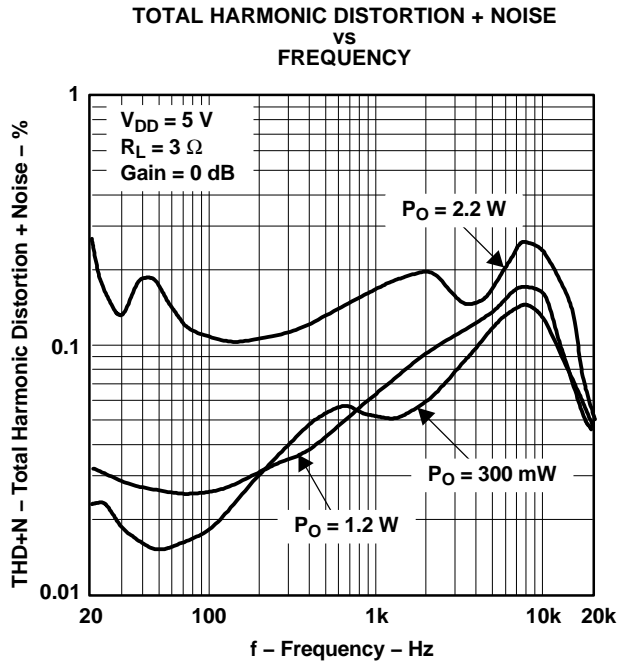

Figure 3.

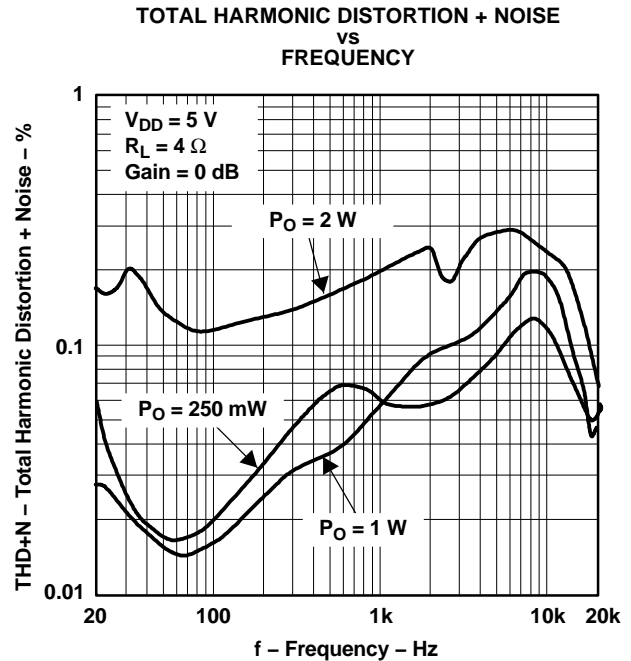

Figure 4.

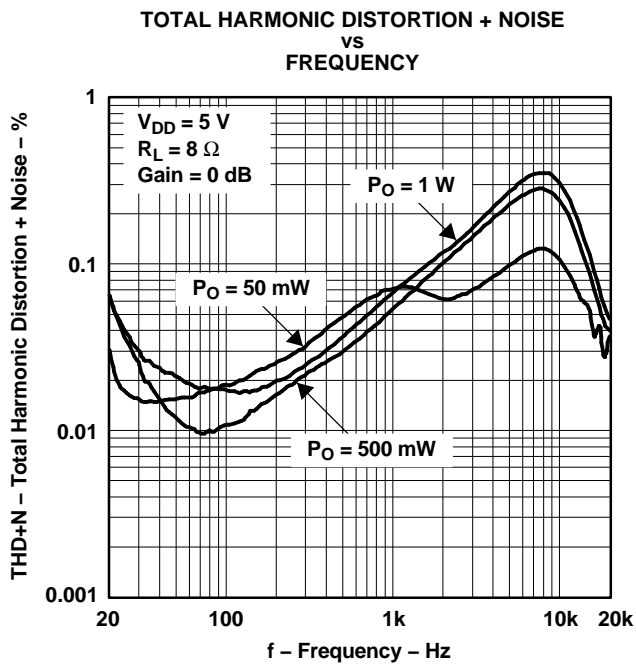

Figure 5.

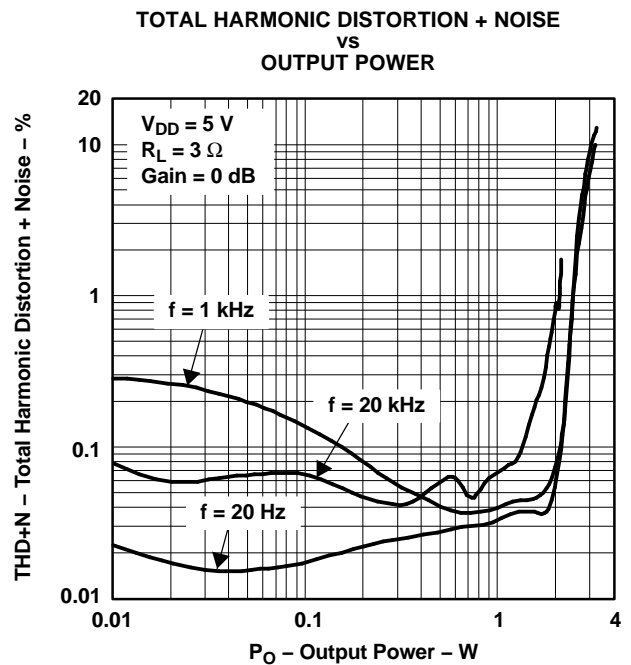

Figure 6.

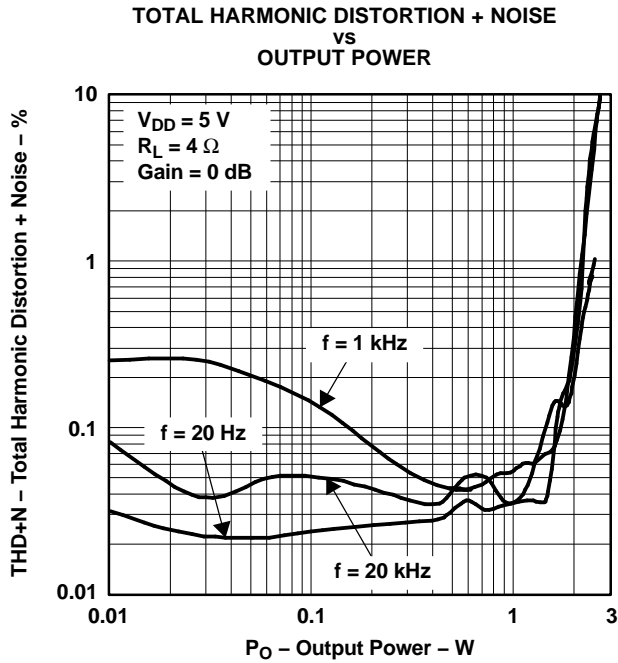

Figure 7.

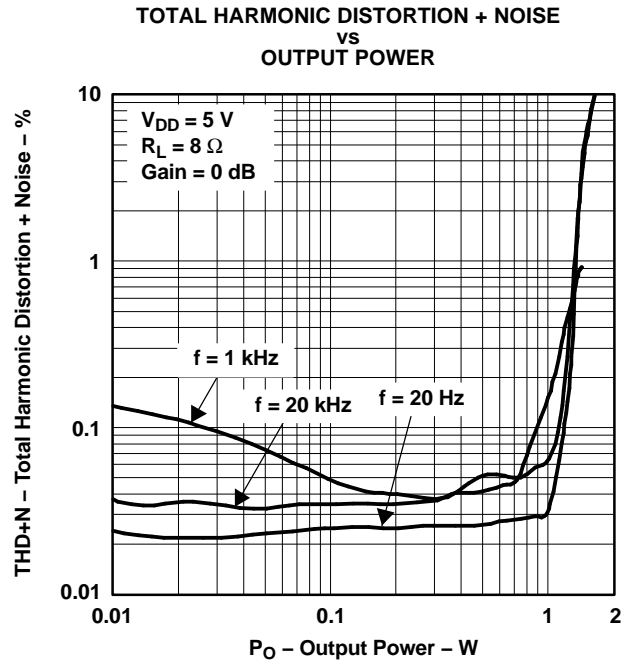

Figure 8.

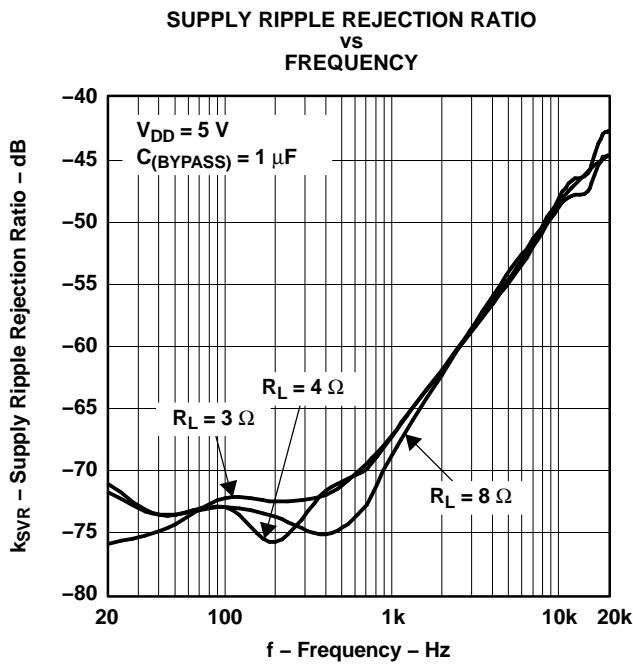

Figure 9.

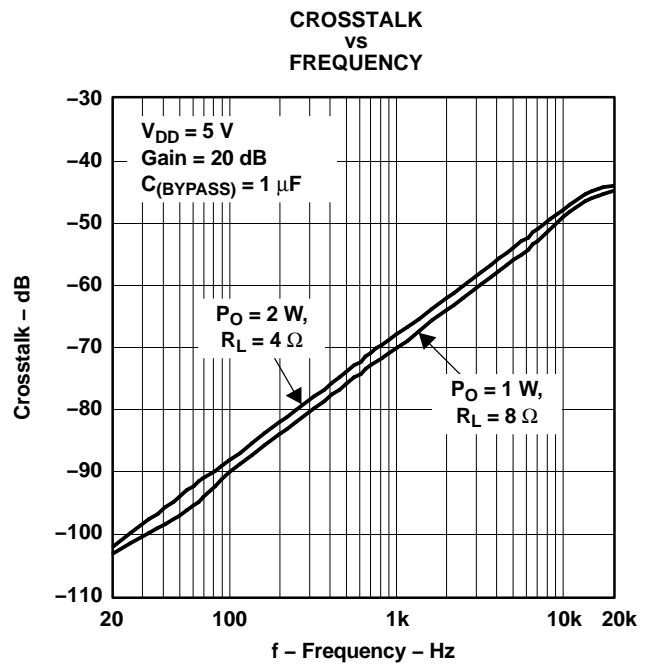

Figure 10.

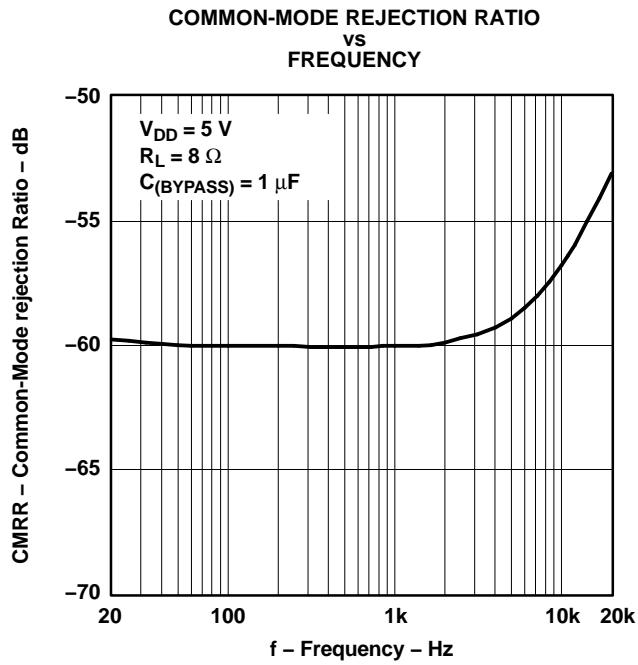

Figure 11.

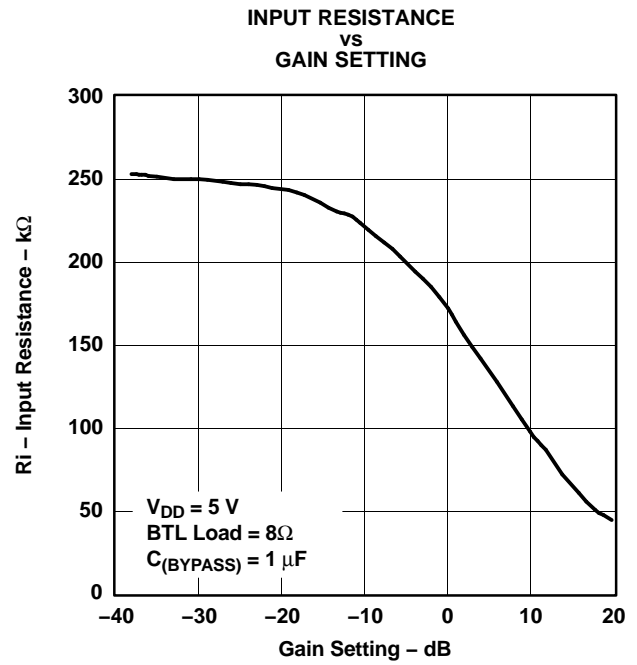

Figure 12.

APPLICATION INFORMATION

APPLICATION CIRCUIT

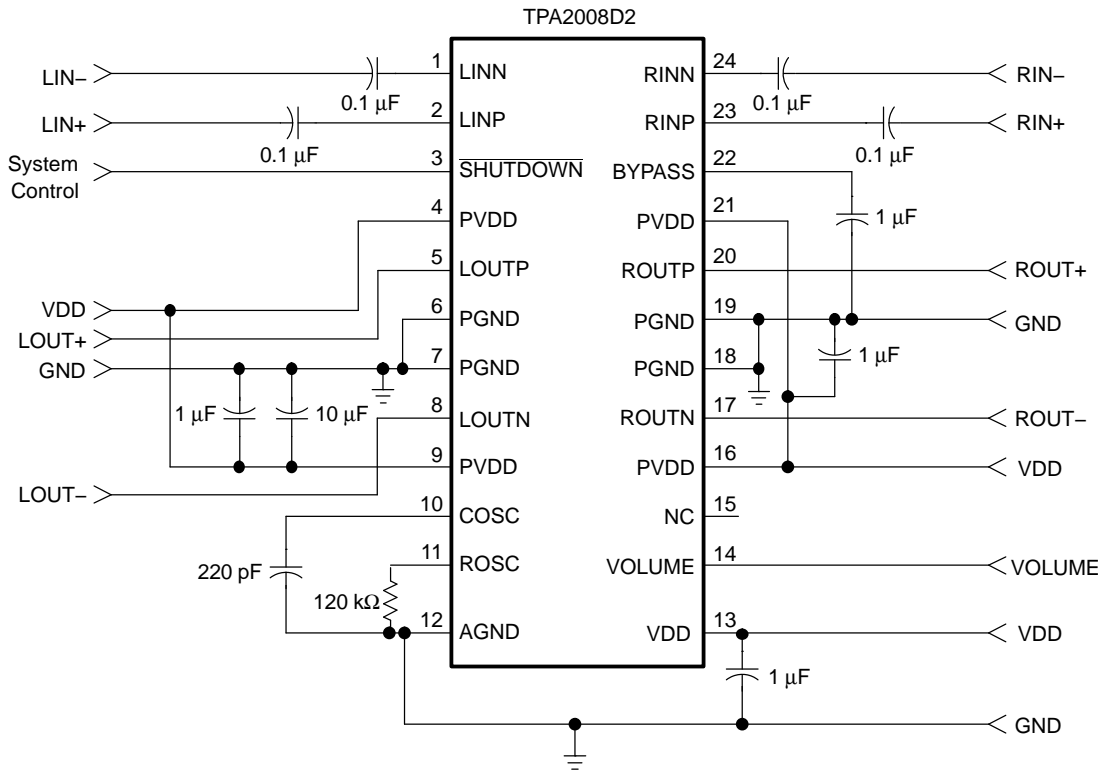

Figure 13. TPA2008D2 In A Stereo Configuration With Differential Inputs

APPLICATION INFORMATION (continued)

TRADITIONAL CLASS-D MODULATION SCHEME

The traditional class-D modulation scheme, which is used in the TPA032D0x family, has a differential output where each output is 180 degrees out of phase and changes from ground to the supply voltage, V_{CC} . Therefore, the differential prefiltered output varies between positive and negative V_{CC} , where filtered 50% duty cycle yields 0 V across the load. The traditional class-D modulation scheme with voltage and current waveforms is shown in Figure 14. Note that even at an average of 0 V across the load (50% duty cycle), the current to the load is high, resulting in a high I^2R loss, thus causing a high supply current.

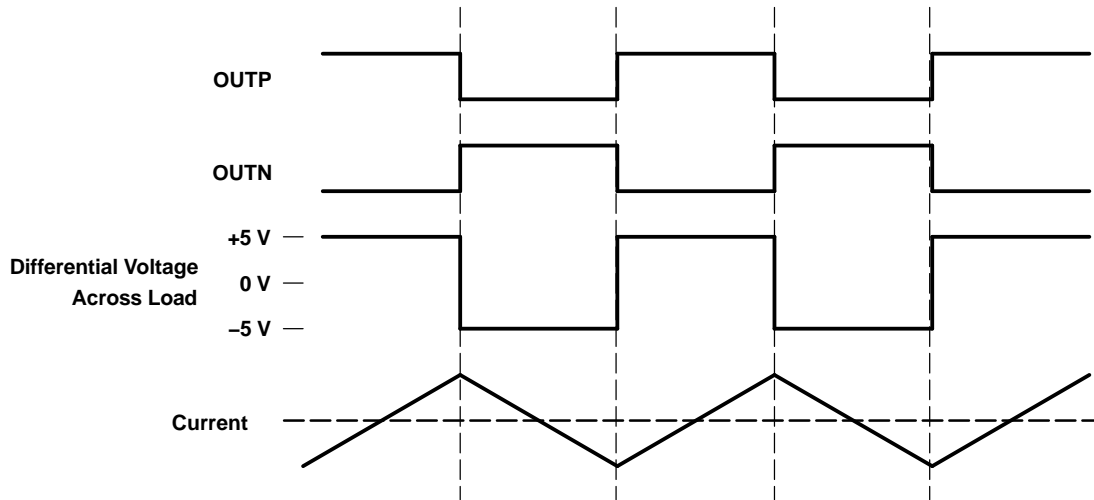

Figure 14. Traditional Class-D Modulation Scheme's Output Voltage and Current Waveforms Into an Inductive Load With No Input

APPLICATION INFORMATION (continued)

TPA2008D2 MODULATION SCHEME

The TPA2008D2 uses a modulation scheme that still has each output switching from 0 to the supply voltage. However, OUPN and OUPP are now in phase with each other with no input. The duty cycle of OUPN is greater than 50% and OUPP is less than 50% for positive output voltages. The duty cycle of OUPN is less than 50% and OUPP is greater than 50% for negative output voltages. The voltage across the load sits at 0 V throughout most of the switching period, greatly reducing the switching current, which reduces any I^2R losses in the load.

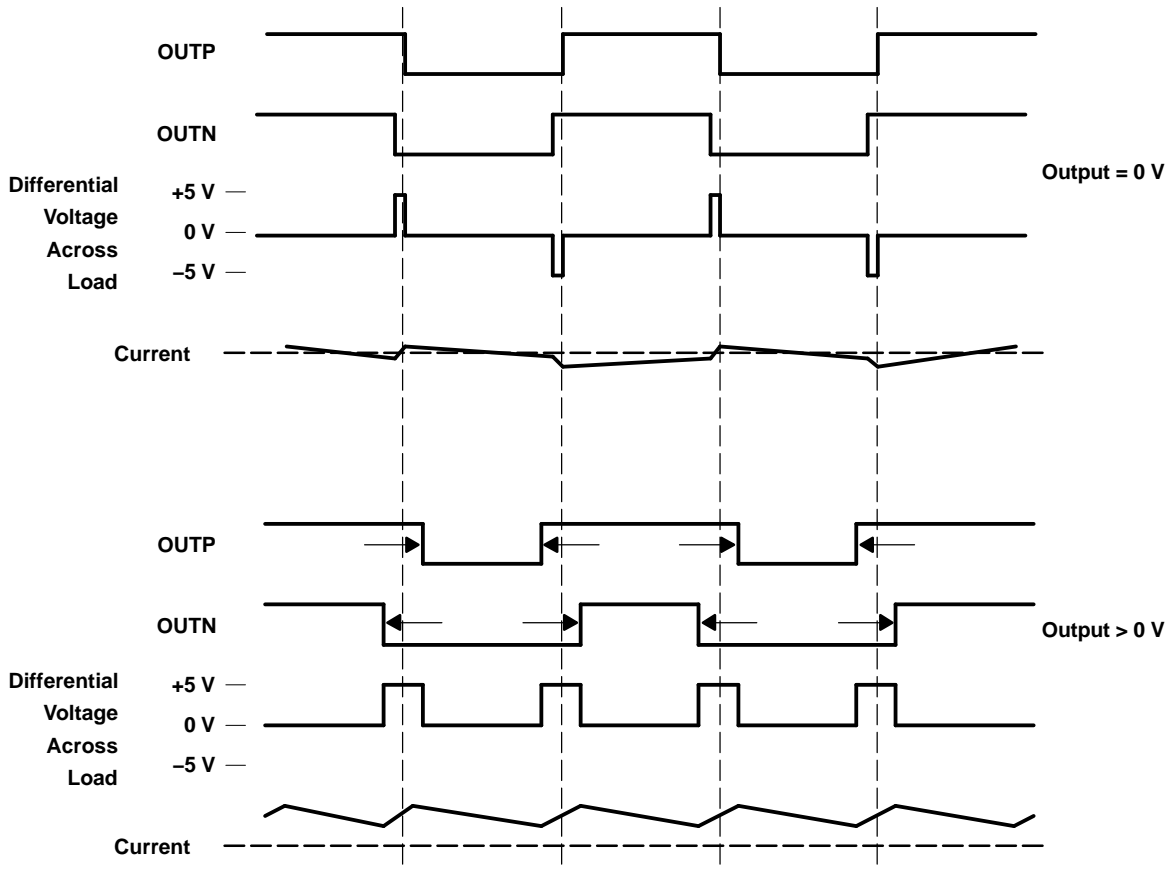

Figure 15. The TPA2008D2 Output Voltage and Current Waveforms Into an Inductive Load

EFFICIENCY: LC FILTER REQUIRED WITH THE TRADITIONAL CLASS-D MODULATION SCHEME

The main reason that the traditional class-D amplifier needs an output filter is that the switching waveform results in maximum current flow. This causes more loss in the load, which causes lower efficiency. The ripple current is large for the traditional modulation scheme, because the ripple current is proportional to voltage multiplied by the time at that voltage. The differential voltage swing is $2 \times V_{DD}$, and the time at each voltage is half the period for the traditional modulation scheme. An ideal LC filter is needed to store the ripple current from each half cycle for the next half cycle, while any resistance causes power dissipation. The speaker is both resistive and reactive, whereas an LC filter is almost purely reactive.

The TPA2008D2 modulation scheme has very little loss in the load without a filter because the pulses are very short and the change in voltage is V_{DD} instead of $2 \times V_{DD}$. As the output power increases, the pulses widen, making the ripple current larger. Ripple current could be filtered with an LC filter for increased efficiency, but for most applications the filter is not needed.

An LC filter with a cutoff frequency less than the class-D switching frequency allows the switching current to flow through the filter instead of the load. The filter has less resistance than the speaker, which results in less power dissipation, therefore increasing efficiency.

APPLICATION INFORMATION (continued)

EFFECTS OF APPLYING A SQUARE WAVE INTO A SPEAKER

Audio specialists have advised for years not to apply a square wave to speakers. If the amplitude of the waveform is high enough and the frequency of the square wave is within the bandwidth of the speaker, the square wave could cause the voice coil to jump out of the air gap and/or scar the voice coil. A 250-kHz switching frequency, however, does not significantly move the voice coil, as the cone movement is proportional to $1/f^2$ for frequencies beyond the audio band.

Damage may occur if the voice coil cannot handle the additional heat generated from the high-frequency switching current. The amount of power dissipated in the speaker may be estimated by first considering the overall efficiency of the system. If the on-resistance ($r_{ds(on)}$) of the output transistors is considered to cause the dominant loss in the system, then the maximum theoretical efficiency for the TPA2008D2 with an 4- Ω load is as follows:

$$\text{Efficiency (theoretical, \%)} = R_L / (R_L + r_{ds(on)}) \times 100\% = 4 / (4 + 0.45) \times 100\% = 89.9\% \quad (1)$$

The maximum measured output power is approximately 2.5 W with a 5-V power supply. The total theoretical power supplied ($P_{(total)}$) for this worst-case condition would therefore be as follows:

$$P_{(total)} = P_O / \text{Efficiency} = 2.5 \text{ W} / 0.899 = 2.781 \text{ W} \quad (2)$$

The efficiency measured in the lab using a 4- Ω speaker was 80%. The power not accounted for as dissipated across the $r_{ds(on)}$ may be calculated by simply subtracting the theoretical power from the measured power:

$$\text{Other losses} = P_{(total)(measured)} - P_{(total)(theoretical)} = 3.025 - 2.781 = 0.244 \text{ W} \quad (3)$$

The quiescent supply current at 5 V is measured to be 7 mA. It can be assumed that the quiescent current encapsulates all remaining losses in the device, i.e., biasing and switching losses. It may be assumed that any remaining power is dissipated in the speaker and is calculated as follows:

$$P_{(dis)} = 0.244 \text{ W} - (5 \text{ V} \times 7 \text{ mA}) = 0.209 \text{ W} \quad (4)$$

Note that these calculations are for the worst-case condition of 2.5 W delivered to the speaker. Since the 0.209 W is only 7.4% of the power delivered to the speaker, it may be concluded that the amount of power actually dissipated in the speaker is relatively insignificant. Furthermore, this power dissipated is well within the specifications of most loudspeaker drivers in a system, as the power rating is typically selected to handle the power generated from a clipping waveform.

WHEN TO USE AN OUTPUT FILTER

Design the TPA2008D2 without the filter if the traces from amplifier to speaker are short (< 1 inch). Powered speakers, where the speaker is in the same enclosure as the amplifier, is a typical application for class-D without a filter.

Many applications require a ferrite bead filter. The ferrite filter reduces EMI around 1 MHz and higher (FCC and CE only test radiated emissions greater than 30 MHz). When selecting a ferrite bead, choose one with high impedance at high frequencies, but low impedance at low frequencies.

Use an LC output filter if there are low frequency (<1 MHz) EMI sensitive circuits and/or there are long wires from the amplifier to the speaker.

APPLICATION INFORMATION (continued)

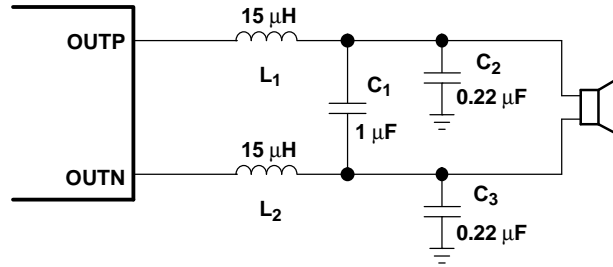

Figure 16. Typical LC Output Filter, Cutoff Frequency of 41 kHz, Speaker Impedance = 4Ω

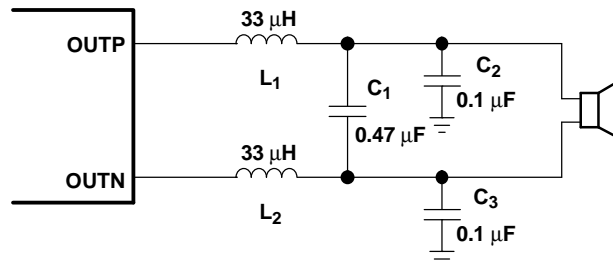

Figure 17. Typical LC Output Filter, Cutoff Frequency of 41 kHz, Speaker Impedance = 8 Ω

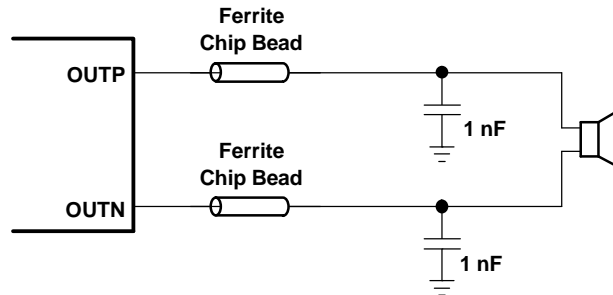

Figure 18. Typical Ferrite Chip Bead Filter (Chip bead example: Fair-Rite 2512067007Y3)

APPLICATION INFORMATION (continued)

VOLUME CONTROL OPERATION

The VOLUME pin controls the volume of the TPA2008D2. It is controlled with a dc voltage, which should not exceed V_{DD} . Table 1 lists the voltage on the VOLUME pin and the corresponding gain.

The trip point, where the gain actually changes, is different depending on whether the voltage on the VOLUME terminal is increasing or decreasing as a result of hysteresis about each trip point. The hysteresis ensures that the gain control is monotonic and does not oscillate from one gain step to another. A pictorial representation of the volume control can be found in Figure 19. The graph focuses on three gain steps with the trip points defined in the first and second columns of Table 1. The dotted lines represent the hysteresis about each gain step.

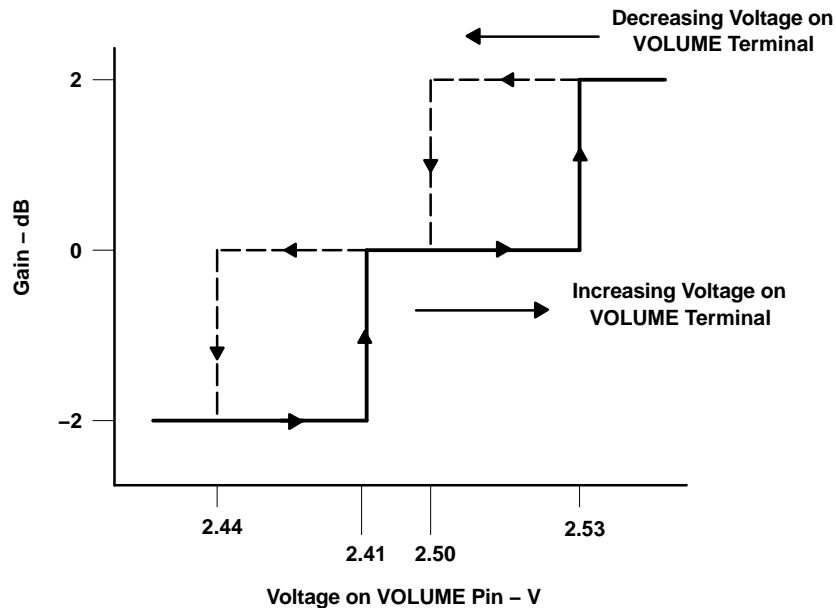

Figure 19. DC Volume Control Operation

SPECIAL LAYOUT CONSIDERATIONS

The voltage on the VOLUME pin must closely track that of the supply voltage, V_{DD} . As the output power is increased, the noise on the power supply will increase. The noise seen by the PV_{DD} pin must also be seen by the VOLUME pin. It is for that reason that absolutely no capacitor should be placed on the VOLUME pin. Additional steps should be taken to reduce the line capacitance on the VOLUME pin, such as reducing line length. Any capacitance on the VOLUME pin will act as a filter, thus making the voltage seen by the VOLUME pin and V_{DD} different. If the difference is large enough, the amplifier will change gain steps.

A star point should be used for power, where the supply voltage for V_{DD} , PV_{DD} , and the volume circuitry can be taken. This point is typically at the bulk decoupling capacitor. The trace connecting the star point to a potentiometer or a DAC should be short. The trace connecting the potentiometer or DAC to the VOLUME pin should be kept as short and straight as possible.

As with the VDD, a star ground should likewise be used. There should exist on the board a point where AGND and PGND converge. This should be the only place where the two grounds are connected. The ground used for the volume control should be AGND. If a potentiometer is to be used to control the volume of the device, it should be connected to AGND. A DAC that has a ground reference should have a short trace to AGND from its ground reference input.

For an example of proper board layout, please refer to the TPA2008D2 EVM User's Guide, document number SLOU116.

APPLICATION INFORMATION (continued)

SELECTION OF COSC AND ROSC

The switching frequency is determined using the values of the components connected to ROSC (pin 11) and COSC (pin 10) and may be calculated with the following equation:

$$f_{OSC} = 6.6 / (R_{OSC} \times C_{OSC}) \quad (5)$$

The frequency may be varied from 200 kHz to 300 kHz by adjusting the values chosen for R_{OSC} and C_{OSC} . The recommended values are $C_{OSC} = 220$ pF, $R_{OSC} = 120$ k Ω for a switching frequency of 250 kHz.

INPUT RESISTANCE

Each gain setting is achieved by varying the input resistance of the amplifier, which can range from its smallest value to over five times that value. As a result, if a single capacitor is used in the input high-pass filter, the -3 dB or cutoff frequency also changes by over five times.

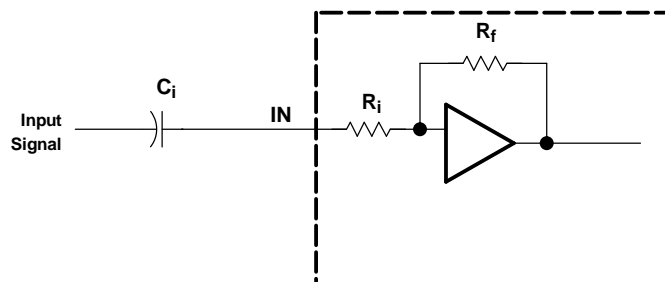

The -3-dB frequency can be calculated using equation Equation 6. See Figure 12. Note that due to process variation, the input resistance, R_i , can change by up to 20%.

$$f_{-3\text{ dB}} = \frac{1}{2\pi C_i R_i} \quad (6)$$

INPUT CAPACITOR, C_i

In a typical application, an input capacitor (C_i) is required to allow the amplifier to bias the input signal to the proper dc level for optimum operation. In this case, C_i and the input resistance of the amplifier (R_i) form a high-pass filter with the corner frequency determined in equation Equation 7.

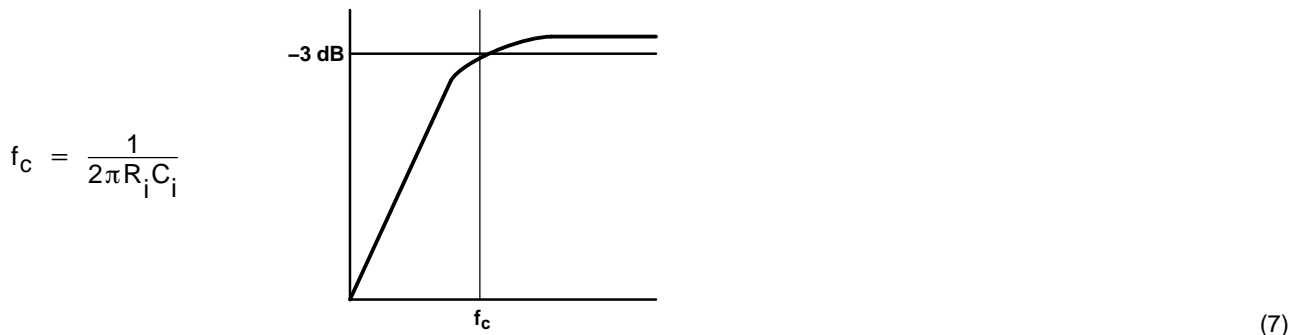

$$f_c = \frac{1}{2\pi R_i C_i} \quad (7)$$

The value of C_i is important, as it directly affects the bass (low frequency) performance of the circuit. Consider the example where R_i is 50 k Ω and the specification calls for a flat bass response down to 30 Hz. Equation Equation 5 is reconfigured as equation Equation 8.

$$C_i = \frac{1}{2\pi R_i f_c} \quad (8)$$

In this example, C_i is 0.1 μ F, so one would likely choose a value in the range of 0.1 μ F to 1 μ F. Figure 12 can be used to determine the input impedance for a given gain and can serve to aid in the calculation of C_i .

APPLICATION INFORMATION (continued)

A further consideration for this capacitor is the leakage path from the input source through the input network (C_i) and the feedback network to the load. This leakage current creates a dc offset voltage at the input to the amplifier that reduces useful headroom, especially in high gain applications. For this reason a low-leakage tantalum or ceramic capacitor is the best choice. When polarized capacitors are used, the positive side of the capacitor should face the amplifier input in most applications as the dc level there is held at $V_{DD}/2$, which is likely higher than the source dc level. Note that it is important to confirm the capacitor polarity in the application.

C_i must be 10 times smaller than the bypass capacitor to reduce clicking and popping noise from power on/off and entering and leaving shutdown. After sizing C_i for a given cutoff frequency, size the bypass capacitor to 10 times that of the input capacitor.

$$C_i \leq C_{BYP} / 10 \quad (9)$$

POWER SUPPLY DECOUPLING, C_s

The TPA2008D2 is a high-performance CMOS audio amplifier that requires adequate power supply decoupling to ensure the output total harmonic distortion (THD) is as low as possible. Power supply decoupling also prevents oscillations for long lead lengths between the amplifier and the speaker. Optimum decoupling is achieved by using two capacitors of different types that target different types of noise on the power supply leads. For higher frequency transients, spikes, or digital hash on the line, a good low equivalent-series-resistance (ESR) ceramic capacitor, typically 0.1 μF , placed as close as possible to the device V_{DD} terminal works best. For filtering lower-frequency noise signals, a larger aluminum electrolytic capacitor of 10 μF or greater placed near the audio power amplifier is recommended.

MIDRAIL BYPASS CAPACITOR, C_{BYP}

The midrail bypass capacitor (C_{BYP}) is the most critical capacitor and serves several important functions. During start-up or recovery from shutdown mode, C_{BYP} determines the rate at which the amplifier starts up. The second function is to reduce noise produced by the power supply caused by coupling into the output drive signal. This noise is from the midrail generation circuit internal to the amplifier, which appears as degraded PSRR and THD+N.

Bypass capacitor (C_{BYP}) values of 0.47- μF to 1- μF ceramic or tantalum low-ESR capacitors are recommended for the best THD and noise performance.

Increasing the bypass capacitor reduces clicking and popping noise from power on/off and entering and leaving shutdown. To have minimal pop, C_{BYP} should be 10 times larger than C_i .

$$C_{BYP} \geq 10 \times C_i \quad (10)$$

DIFFERENTIAL INPUT

The differential input stage of the amplifier cancels any noise that appears on both input lines of the channel. To use the TPA2008D2 EVM with a differential source, connect the positive lead of the audio source to the INP input and the negative lead from the audio source to the INN input. To use the TPA2008D2 with a single-ended source, ac ground either input through a capacitor and apply the audio signal to the remaining input. In a single-ended input application, the unused input should be ac-grounded at the audio source instead of at the device input for best noise performance.

SHUTDOWN MODES

The TPA2008D2 employs a shutdown mode of operation designed to reduce supply current (I_{DD}) to the absolute minimum level during periods of nonuse for battery-power conservation. The **SHUTDOWN** input terminal should be held high during normal operation when the amplifier is in use. Pulling **SHUTDOWN** low causes the outputs to mute and the amplifier to enter a low-current state, $I_{DD(SD)} = 1 \mu\text{A}$. **SHUTDOWN** should never be left unconnected because the amplifier state would be unpredictable.

APPLICATION INFORMATION (continued)

USING LOW-ESR CAPACITORS

Low-ESR capacitors are recommended throughout this application section. A real (as opposed to ideal) capacitor can be modeled simply as a resistor in series with an ideal capacitor. The voltage drop across this resistor minimizes the beneficial effects of the capacitor in the circuit. The lower the equivalent value of this resistance the more the real capacitor behaves like an ideal capacitor.

SHORT-CIRCUIT PROTECTION

The TPA2008D2 has short circuit protection circuitry on the outputs that prevents damage to the device during output-to-output shorts, output-to-GND shorts, and output-to- V_{DD} shorts. When a short-circuit is detected on the outputs, the part immediately goes into shutdown. This is a latched fault and must be reset by cycling the voltage on the **SHUTDOWN** pin to a logic low and back to the logic high, or by cycling the power off and then back on. This clears the short-circuit flag and allows for normal operation if the short was removed. If the short was not removed, the protection circuitry activates again.

LOW-SUPPLY VOLTAGE DETECTION

The TPA2008D2 incorporates circuitry designed to detect when the supply voltage is low. When the supply voltage reaches 1.8 V or below, the TPA2008D2 goes into a state of shutdown. The current consumption drops from millamperes to microamperes, leaving the remaining battery power for more essential devices such as microprocessors. When the supply voltage level returns to normal, the device comes out of its shutdown state and starts to draw current again. Note that even though the device is drawing several milliamperes of current, it is not operationally functional until $V_{DD} \geq 4.5$ V.

THERMAL PROTECTION

Thermal protection on the TPA2008D2 prevents damage to the device when the internal die temperature exceeds 150°C. There is a ± 15 degree tolerance on this trip point from device to device. Once the die temperature exceeds the thermal set point, the device enters into the shutdown state and the outputs are disabled. This is not a latched fault. The thermal fault is cleared once the temperature of the die is reduced by 20°C. The device begins normal operation at this point with no external system interaction.

THERMAL CONSIDERATIONS: OUTPUT POWER AND MAXIMUM AMBIENT TEMPERATURE

To calculate the maximum ambient temperature, the following equation may be used:

$$T_{Amax} = T_J - \Theta_{JA} P_{Dissipated}$$

$$\text{where: } T_J = 125^\circ\text{C}$$

$$\Theta_{JA} = 45.87^\circ\text{C/W}$$

(11)

(The derating factor for the 24-pin PWP package is given in the dissipation rating table.)

To estimate the power dissipation, the following equation may be used:

$$P_{Dissipated} = P_{O(average)} \times ((1 / \text{Efficiency}) - 1)$$

$$\text{Efficiency} = \sim 85\% \text{ for an } 8\text{-}\Omega \text{ load}$$

$$= \sim 80\% \text{ for a } 4\text{-}\Omega \text{ load}$$

$$= \sim 75\% \text{ for a } 3\text{-}\Omega \text{ load}$$

(12)

Example. What is the maximum ambient temperature for an application that requires the TPA2008D2 to drive 2 W into a 4- Ω speaker (stereo)?

$$P_{Dissipated} = 4 \text{ W} \times ((1 / 0.8) - 1) = 1 \text{ W}$$

$$(P_O = 2 \text{ W} \times 2)$$

$$T_{Amax} = 125^\circ\text{C} - (45.87^\circ\text{C/W} \times 1 \text{ W}) = 79.13^\circ\text{C}$$

PACKAGING INFORMATION

Orderable Device	Status (1)	Package Type	Package Drawing	Pins	Package Qty	Eco Plan (2)	Lead finish/ Ball material (6)	MSL Peak Temp (3)	Op Temp (°C)	Device Marking (4/5)	Samples
TPA2008D2PWP	ACTIVE	HTSSOP	PWP	24	60	RoHS & Green	NIPDAU	Level-2-260C-1 YEAR	-40 to 85	TPA2008D2	Samples
TPA2008D2PWPR	ACTIVE	HTSSOP	PWP	24	2000	RoHS & Green	NIPDAU	Level-2-260C-1 YEAR	-40 to 85	TPA2008D2	Samples
TPA2008D2PWPRG4	ACTIVE	HTSSOP	PWP	24	2000	RoHS & Green	NIPDAU	Level-2-260C-1 YEAR	-40 to 85	TPA2008D2	Samples

(1) The marketing status values are defined as follows:

ACTIVE: Product device recommended for new designs.

LIFEBUY: TI has announced that the device will be discontinued, and a lifetime-buy period is in effect.

NRND: Not recommended for new designs. Device is in production to support existing customers, but TI does not recommend using this part in a new design.

PREVIEW: Device has been announced but is not in production. Samples may or may not be available.

OBSOLETE: TI has discontinued the production of the device.

(2) **RoHS:** TI defines "RoHS" to mean semiconductor products that are compliant with the current EU RoHS requirements for all 10 RoHS substances, including the requirement that RoHS substance do not exceed 0.1% by weight in homogeneous materials. Where designed to be soldered at high temperatures, "RoHS" products are suitable for use in specified lead-free processes. TI may reference these types of products as "Pb-Free".

RoHS Exempt: TI defines "RoHS Exempt" to mean products that contain lead but are compliant with EU RoHS pursuant to a specific EU RoHS exemption.

Green: TI defines "Green" to mean the content of Chlorine (Cl) and Bromine (Br) based flame retardants meet JS709B low halogen requirements of <=1000ppm threshold. Antimony trioxide based flame retardants must also meet the <=1000ppm threshold requirement.

(3) MSL, Peak Temp. - The Moisture Sensitivity Level rating according to the JEDEC industry standard classifications, and peak solder temperature.

(4) There may be additional marking, which relates to the logo, the lot trace code information, or the environmental category on the device.

(5) Multiple Device Markings will be inside parentheses. Only one Device Marking contained in parentheses and separated by a "~" will appear on a device. If a line is indented then it is a continuation of the previous line and the two combined represent the entire Device Marking for that device.

(6) Lead finish/Ball material - Orderable Devices may have multiple material finish options. Finish options are separated by a vertical ruled line. Lead finish/Ball material values may wrap to two lines if the finish value exceeds the maximum column width.

Important Information and Disclaimer:The information provided on this page represents TI's knowledge and belief as of the date that it is provided. TI bases its knowledge and belief on information provided by third parties, and makes no representation or warranty as to the accuracy of such information. Efforts are underway to better integrate information from third parties. TI has taken and continues to take reasonable steps to provide representative and accurate information but may not have conducted destructive testing or chemical analysis on incoming materials and chemicals. TI and TI suppliers consider certain information to be proprietary, and thus CAS numbers and other limited information may not be available for release.

In no event shall TI's liability arising out of such information exceed the total purchase price of the TI part(s) at issue in this document sold by TI to Customer on an annual basis.

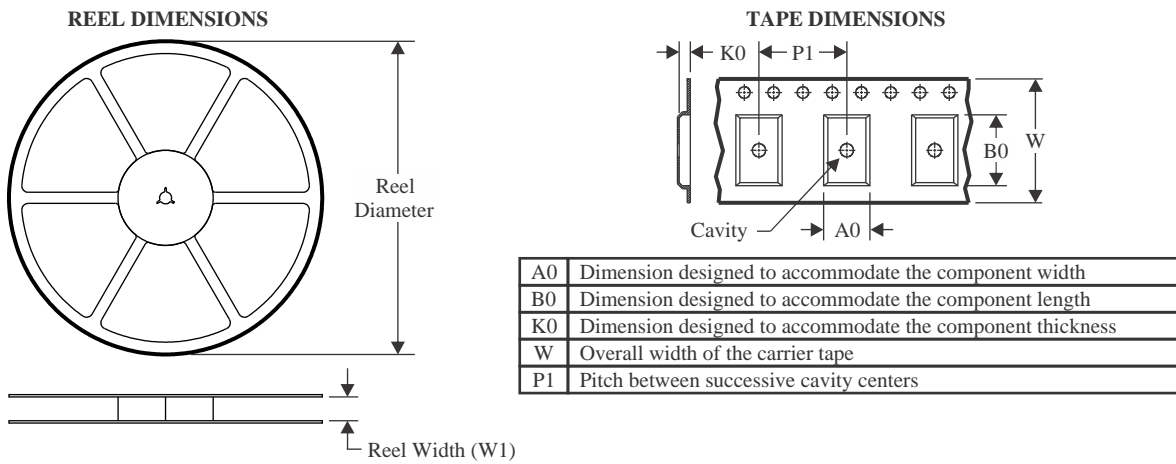
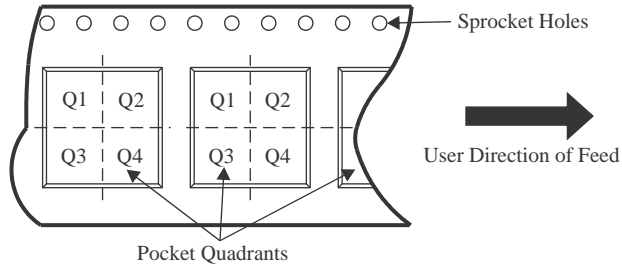
TAPE AND REEL INFORMATION

QUADRANT ASSIGNMENTS FOR PIN 1 ORIENTATION IN TAPE

*All dimensions are nominal

Device	Package Type	Package Drawing	Pins	SPQ	Reel Diameter (mm)	Reel Width W1 (mm)	A0 (mm)	B0 (mm)	K0 (mm)	P1 (mm)	W (mm)	Pin1 Quadrant
TPA2008D2PWPR	HTSSOP	PWP	24	2000	330.0	16.4	6.95	8.3	1.6	8.0	16.0	Q1
TPA2008D2PWPR	HTSSOP	PWP	24	2000	330.0	16.4	6.95	8.3	1.6	8.0	16.0	Q1

TAPE AND REEL BOX DIMENSIONS



*All dimensions are nominal

Device	Package Type	Package Drawing	Pins	SPQ	Length (mm)	Width (mm)	Height (mm)
TPA2008D2PWPR	HTSSOP	PWP	24	2000	356.0	356.0	35.0
TPA2008D2PWPR	HTSSOP	PWP	24	2000	350.0	350.0	43.0

TUBE

*All dimensions are nominal

Device	Package Name	Package Type	Pins	SPQ	L (mm)	W (mm)	T (μm)	B (mm)
TPA2008D2PWP	PWP	HTSSOP	24	60	530	10.2	3600	3.5
TPA2008D2PWP	PWP	HTSSOP	24	60	530	10.2	3600	3.5

GENERIC PACKAGE VIEW

PWP 24

PowerPAD™ TSSOP - 1.2 mm max height

4.4 x 7.6, 0.65 mm pitch

PLASTIC SMALL OUTLINE

This image is a representation of the package family, actual package may vary.
Refer to the product data sheet for package details.

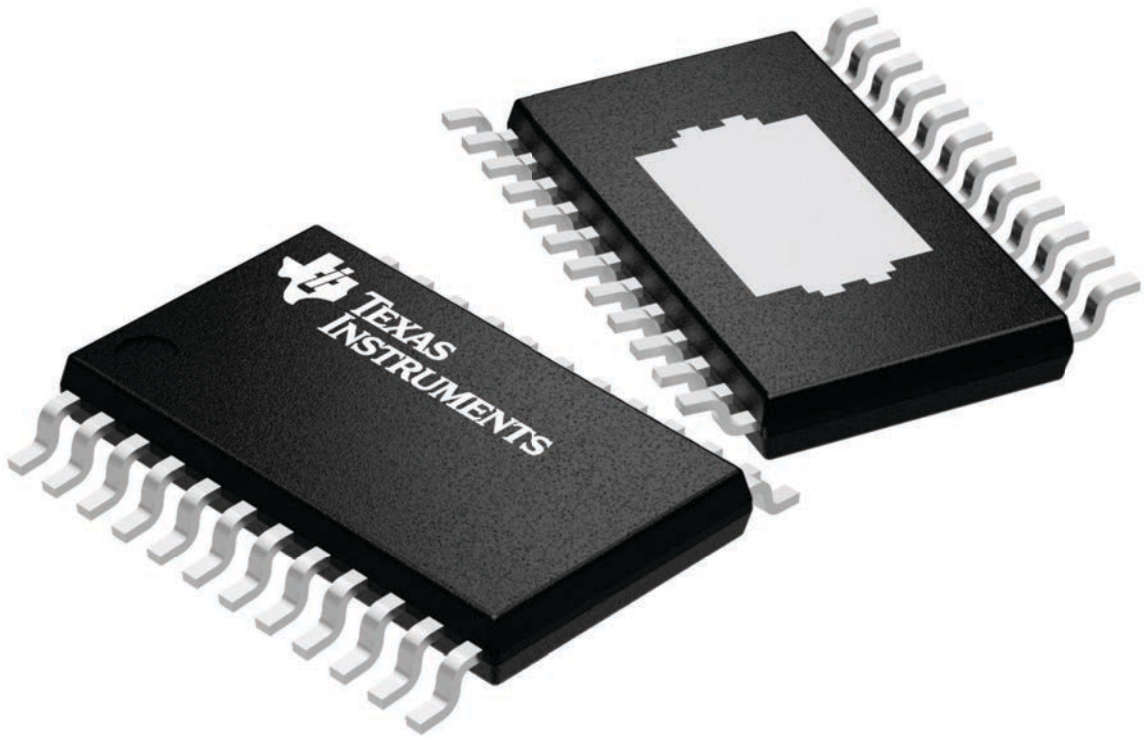

4224742/B

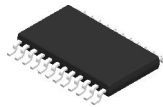

PACKAGE OUTLINE

PWP0024B

PowerPAD™ TSSOP - 1.2 mm max height

PLASTIC SMALL OUTLINE

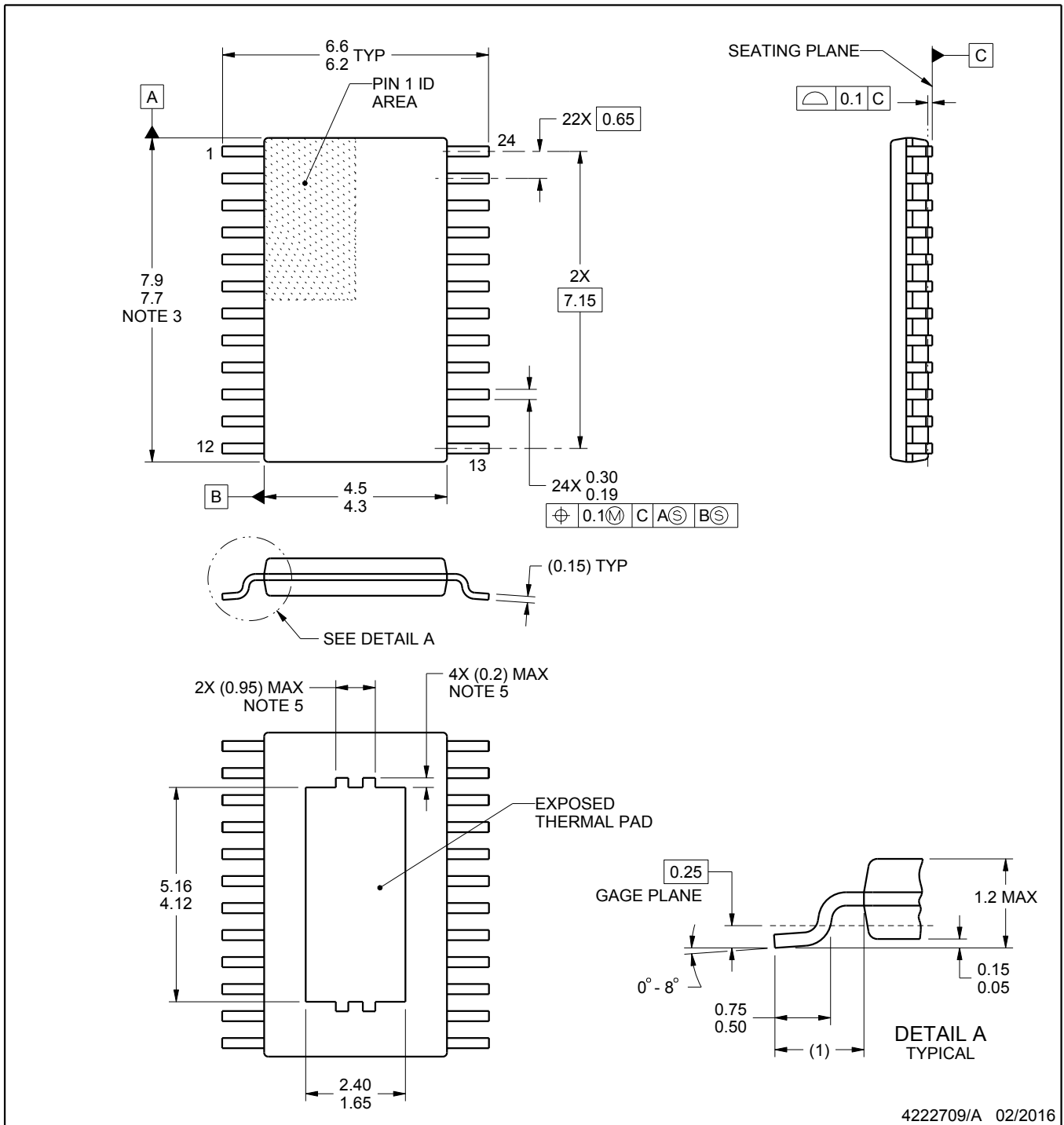

4222709/A 02/2016

NOTES:

PowerPAD is a trademark of Texas Instruments.

1. All linear dimensions are in millimeters. Any dimensions in parenthesis are for reference only. Dimensioning and tolerancing per ASME Y14.5M.
2. This drawing is subject to change without notice.
3. This dimension does not include mold flash, protrusions, or gate burrs. Mold flash, protrusions, or gate burrs shall not exceed 0.15 mm per side.
4. Reference JEDEC registration MO-153.
5. Features may not be present and may vary.

EXAMPLE BOARD LAYOUT

PWP0024B

PowerPAD™ TSSOP - 1.2 mm max height

PLASTIC SMALL OUTLINE

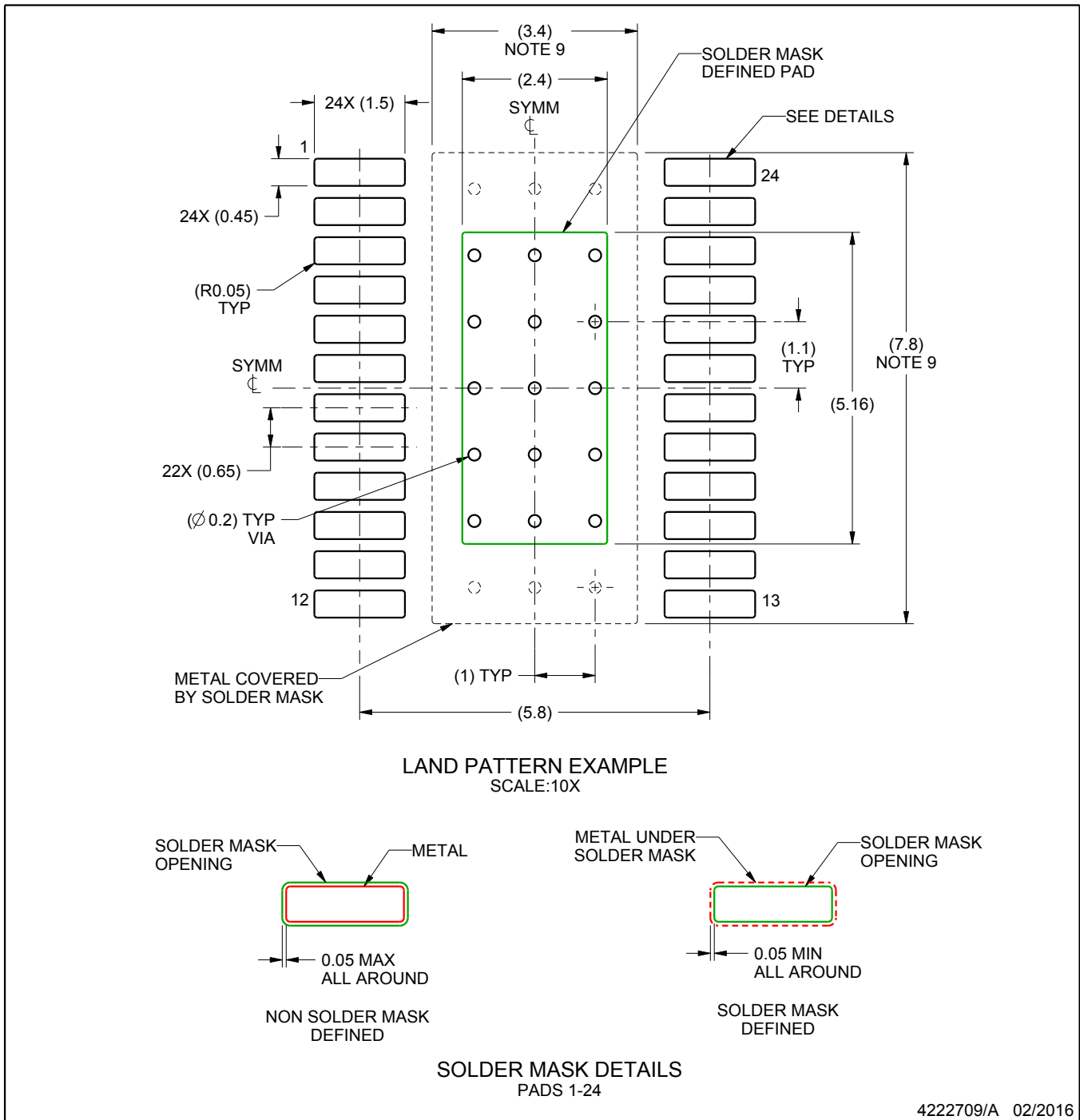

NOTES: (continued)

6. Publication IPC-7351 may have alternate designs.
7. Solder mask tolerances between and around signal pads can vary based on board fabrication site.
8. This package is designed to be soldered to a thermal pad on the board. For more information, see Texas Instruments literature numbers SLMA002 (www.ti.com/lit/slma002) and SLMA004 (www.ti.com/lit/slma004).
9. Size of metal pad may vary due to creepage requirement.

EXAMPLE STENCIL DESIGN

PWP0024B

PowerPAD™ TSSOP - 1.2 mm max height

PLASTIC SMALL OUTLINE

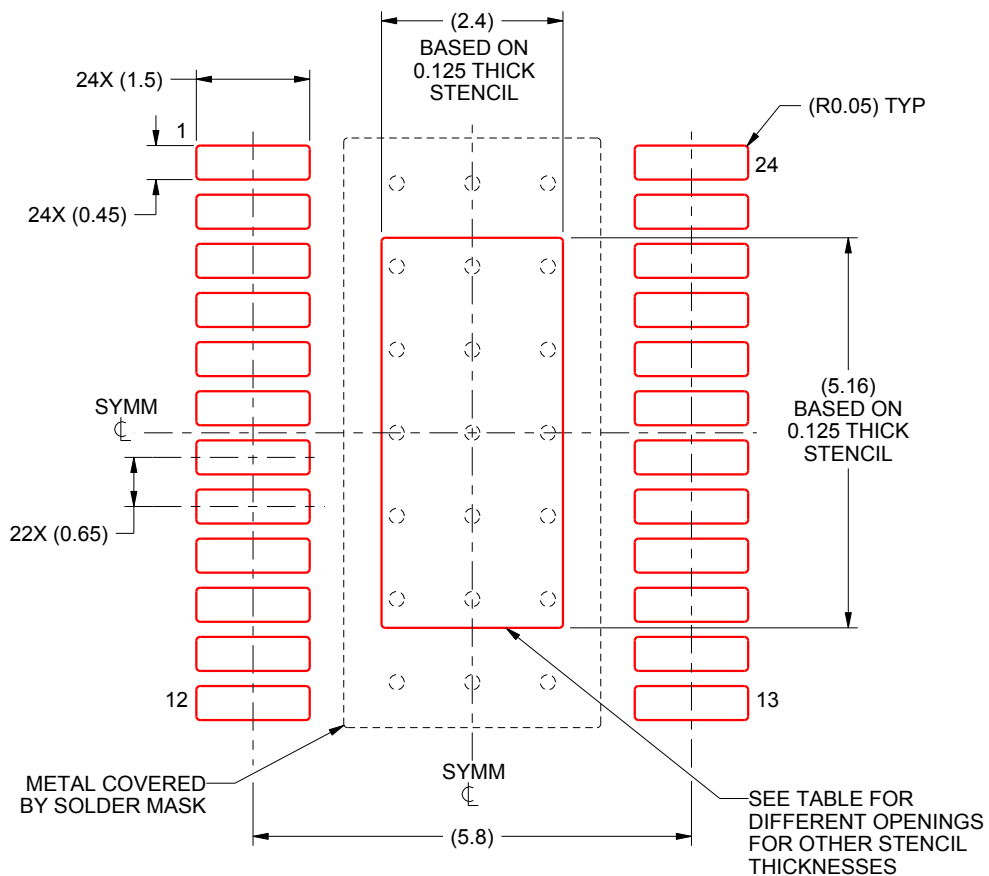

SOLDER PASTE EXAMPLE
EXPOSED PAD
100% PRINTED SOLDER COVERAGE BY AREA
SCALE:10X

STENCIL THICKNESS	SOLDER STENCIL OPENING
0.1	2.68 X 5.77
0.125	2.4 X 5.16 (SHOWN)
0.15	2.19 X 4.71
0.175	2.03 X 4.36

4222709/A 02/2016

NOTES: (continued)

10. Laser cutting apertures with trapezoidal walls and rounded corners may offer better paste release. IPC-7525 may have alternate design recommendations.
11. Board assembly site may have different recommendations for stencil design.

IMPORTANT NOTICE AND DISCLAIMER

TI PROVIDES TECHNICAL AND RELIABILITY DATA (INCLUDING DATA SHEETS), DESIGN RESOURCES (INCLUDING REFERENCE DESIGNS), APPLICATION OR OTHER DESIGN ADVICE, WEB TOOLS, SAFETY INFORMATION, AND OTHER RESOURCES "AS IS" AND WITH ALL FAULTS, AND DISCLAIMS ALL WARRANTIES, EXPRESS AND IMPLIED, INCLUDING WITHOUT LIMITATION ANY IMPLIED WARRANTIES OF MERCHANTABILITY, FITNESS FOR A PARTICULAR PURPOSE OR NON-INFRINGEMENT OF THIRD PARTY INTELLECTUAL PROPERTY RIGHTS.

These resources are intended for skilled developers designing with TI products. You are solely responsible for (1) selecting the appropriate TI products for your application, (2) designing, validating and testing your application, and (3) ensuring your application meets applicable standards, and any other safety, security, regulatory or other requirements.

These resources are subject to change without notice. TI grants you permission to use these resources only for development of an application that uses the TI products described in the resource. Other reproduction and display of these resources is prohibited. No license is granted to any other TI intellectual property right or to any third party intellectual property right. TI disclaims responsibility for, and you will fully indemnify TI and its representatives against, any claims, damages, costs, losses, and liabilities arising out of your use of these resources.

TI's products are provided subject to [TI's Terms of Sale](#) or other applicable terms available either on [ti.com](https://www.ti.com) or provided in conjunction with such TI products. TI's provision of these resources does not expand or otherwise alter TI's applicable warranties or warranty disclaimers for TI products.

TI objects to and rejects any additional or different terms you may have proposed.

Mailing Address: Texas Instruments, Post Office Box 655303, Dallas, Texas 75265
Copyright © 2023, Texas Instruments Incorporated