

2.75-W FIXED GAIN MONO FILTER-FREE CLASS-D AUDIO POWER AMPLIFIER

FEATURES

- Maximize Battery Life and Minimize Heat
 - 0.5- μ A Shutdown Current
 - 3.0-mA Quiescent Current
 - High Efficiency Class-D
 - 88% at 400mW at 8 Ω
 - 80% at 100mW at 8 Ω
- Three Fixed Gain Versions
 - TPA2032D1 has a gain of 2 V/V (6dB)
 - TPA2033D1 has a gain of 3 V/V (9.5dB)
 - TPA2034D1 has a gain of 4 V/V (12dB)
- Only One External Component Required
 - Internal Matched Input Gain and Feedback Resistors for Excellent PSRR and CMRR
 - Optimized PWM Output Stage Eliminates LC Output Filter
 - PSRR (–75 dB) and Wide Supply Voltage (2.5 V to 5.5 V) Eliminates Need for a Dedicated Voltage Regulator
 - Fully Differential Design Reduces RF Rectification and Eliminates Bypass Capacitor
 - CMRR (–69 dB) Eliminates Two Input Coupling Capacitors
- Thermal and Short-Circuit Protection
- Pinout Very Similar to TPA2010D1

- Wafer Chip Scale Packaging (WCSP)
 - NanoFree™ Lead-Free (Pb-Free: YZF)

APPLICATIONS

- Ideal for Wireless Handsets, PDAs, and other mobile devices

DESCRIPTION

The TPA2032D1 (2V/V gain), TPA2033D1 (3V/V gain), and TPA2034D1 (4V/V gain) are 2.75-W high efficiency filter-free class-D audio power amplifiers, each in an approximately 1.5-mm \times 1.5-mm wafer chip scale package (WCSP) that requires only one external component. The pinout is the same as the TPA2010D1 except that the external gain setting input resistors required by the TPA2010D1 are integrated into the fixed gain TPA203xD1 family.

Features like –75dB PSRR and improved RF-rectification immunity with a very small PCB footprint (WCSP amplifier plus single decoupling cap) make the TPA203xD1 family ideal for wireless handsets. A fast start-up time of 3.2 ms with minimal pop makes the TPA203xD1 family ideal for PDA applications.

In wireless handsets, the earpiece, speaker phone, and melody ringer can each be driven by a TPA203xD1. The TPA203xD1 family has a low 27- μ V noise floor, A-weighted.

APPLICATION CIRCUIT

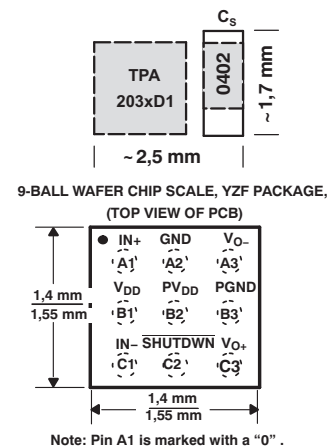
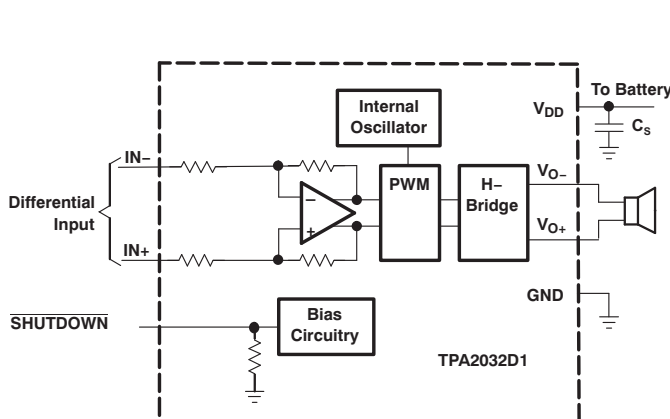

Please be aware that an important notice concerning availability, standard warranty, and use in critical applications of Texas Instruments semiconductor products and disclaimers thereto appears at the end of this data sheet.

NanoFree is a trademark of Texas Instruments.



These devices have limited built-in ESD protection. The leads should be shorted together or the device placed in conductive foam during storage or handling to prevent electrostatic damage to the MOS gates.

ORDERING INFORMATION

T _A	PACKAGE	PART NUMBER	SYMBOL
–40°C to 85°C	Wafer chip scale packaging – Lead free (YZF)	TPA2032D1YZF ⁽¹⁾	BPX
–40°C to 85°C	Wafer chip scale packaging – Lead free (YZF)	TPA2033D1YZF ⁽¹⁾	BPY
–40°C to 85°C	Wafer chip scale packaging – Lead free (YZF)	TPA2034D1YZF ⁽¹⁾	BPZ

(1) The YZF package is only available taped and reeled. To order add the suffix *R* to the end of the part number for a reel of 3000, or add the suffix *T* to the end of the part number for a reel of 250 (e.g. TPA2032D1YZFR).

ABSOLUTE MAXIMUM RATINGS

over operating free-air temperature range unless otherwise noted⁽¹⁾

		TPA2032D1, TPA2033D1, TPA2034D1
V _{DD}	Supply voltage	
		In active mode –0.3 V to 6 V In <u>SHUTDOWN</u> mode –0.3 V to 7 V
V _I	Input voltage	–0.3 V to V _{DD} + 0.3 V
	Continuous total power dissipation	See Dissipation Rating Table
T _A	Operating free-air temperature	–40°C to 85°C
T _J	Operating junction temperature	–40°C to 125°C
T _{stg}	Storage temperature	–65°C to 150°C
ESD	Electro-Static Discharge Tolerance - Human Body Model (HBM) for all pins ⁽²⁾	2KV

- (1) Stresses beyond those listed under *absolute maximum ratings* may cause permanent damage to the device. These are stress ratings only, and functional operation of the device at these or any other conditions beyond those indicated under *recommended operating conditions* is not implied. Exposure to absolute-maximum-rated conditions for extended periods may affect device reliability.
- (2) The output pins Vo– and Vo+ are tolerant to 1.5KV HBM ESD

RECOMMENDED OPERATING CONDITIONS

		MIN	NOM	MAX	UNIT
V _{DD}	Supply voltage	2.5		5.5	V
V _{IH}	High-level input voltage	SHUTDOWN		V _{DD}	V
V _{IL}	Low-level input voltage	SHUTDOWN		0.35	V
V _{IC}	Common mode input voltage range	V _{DD} = 2.5 V, 5.5 V		V _{DD} –0.8	V
T _A	Operating free-air temperature	–40		85	°C

PACKAGE DISSIPATION RATINGS

PACKAGE	DERATING FACTOR (1 / θ _{JA})	T _A ≤ 25°C POWER RATING	T _A = 70°C POWER RATING	T _A = 85°C POWER RATING
YZF	4.8 mW/°C ⁽¹⁾	480 mW	264 mW	192 mW
YZF	7.5 mW/°C ⁽²⁾	750 mW	412 mW	300 mW

- (1) Derating factor measured with JEDEC Low-K board; 1S0P - One signal layer and zero plane layers.
- (2) Derating factor measured with JEDEC High K board; 1S2P - One signal layer and two plane layers.
 Please see JEDEC Standard 51-3 for Low-K board, JEDEC Standard 51-7 for High-K board, and JEDEC Standard 51-12 for using package thermal information.
 Please see JEDEC document page for downloadable copies: <http://www.jedec.org/download/default.cfm>.

ELECTRICAL CHARACTERISTICS

 $T_A = 25^\circ\text{C}$ (unless otherwise noted)

PARAMETER		TEST CONDITIONS	MIN	TYP	MAX	UNIT	
V _{OS}	Output offset voltage (measured differentially)	Inputs AC grounded, V _{DD} = 2.5 V to 5.5 V	TPA2032D1	5	25	mV	
			TPA2033D1	5	25		
			TPA2034D1	5	25		
PSRR	Power supply rejection ratio	V _{DD} = 2.5 V to 5.5 V	-75	-61		dB	
CMRR	Common mode rejection ratio	V _{IC} = 0.5 V to (V _{DD} - 0.8 V)	V _{DD} = 2.5 V	-69	-52	dB	
			V _{DD} = 3.6 V	-69	-52		
			V _{DD} = 5.5 V	-69	-52		
I _{IH}	High-level input current	V _{DD} = 5.5 V, V _I = 5.8 V			50	μA	
I _{IL}	Low-level input current	V _{DD} = 5.5 V, V _I = -0.3 V			5	μA	
I _(Q)	Quiescent current	V _{DD} = 5.5 V, no load		4	5.7	mA	
		V _{DD} = 3.6 V, no load		3			
		V _{DD} = 2.5 V, no load		2.2	3.7		
I _(SD)	Shutdown current	V _(SHUTDOWN) = 0.35 V, V _{DD} = 2.5 V to 5.5 V		0.5	0.8	μA	
r _{DS(on)}	Static drain-source on-state resistance	V _{DD} = 2.5 V		550		mΩ	
		V _{DD} = 3.6 V		420			
		V _{DD} = 5.0 V		350			
	Output impedance in SHUTDOWN	V _(SHUTDOWN) ≤ 0.35 V		2		kΩ	
f _(sw)	Switching frequency	V _{DD} = 2.5 V to 5.5 V	240	300	400	kHz	
Gain		V _{DD} = 2.5 V to 5.5 V	TPA2032D1	5.5	6	6.5	dB
			TPA2033D1	9.0	9.5	10.0	
			TPA2034D1	11.5	12	12.5	
R _{PD}	Resistance of internal pulldown resistor from shutdown pin to GND			300		kΩ	

OPERATING CHARACTERISTICS

 $T_A = 25^\circ\text{C}$, R_L = 8 Ω (unless otherwise noted)

PARAMETER		TEST CONDITIONS	MIN	TYP	MAX	UNIT
P _O	Output power	R _L = 4 Ω, THD + N = 10%, f = 1 kHz	V _{DD} = 5 V		2.75	W
			V _{DD} = 3.6 V		1.35	
			V _{DD} = 2.5 V		0.59	
		R _L = 4 Ω, THD + N = 1%, f = 1 kHz	V _{DD} = 5 V		2.25	W
			V _{DD} = 3.6 V		1.12	
			V _{DD} = 2.5 V		0.48	
		R _L = 8 Ω, THD + N = 10%, f = 1 kHz	V _{DD} = 5 V		1.68	W
			V _{DD} = 3.6 V		0.85	
			V _{DD} = 2.5 V		0.38	
		R _L = 8 Ω, THD + N = 1%, f = 1 kHz	V _{DD} = 5 V		1.37	W
			V _{DD} = 3.6 V		0.68	
			V _{DD} = 2.5 V		0.31	
THD+N	Total harmonic distortion plus noise	V _{DD} = 5 V, P _O = 1 W, R _L = 8 Ω, f = 1 kHz		0.18%		
		V _{DD} = 3.6 V, P _O = 0.5 W, R _L = 8 Ω, f = 1 kHz		0.11%		
		V _{DD} = 2.5 V, P _O = 200 mW, R _L = 8 Ω, f = 1 kHz		0.10%		
k _{SVR}	Supply ripple rejection ratio	V _{DD} = 3.6 V, Inputs AC grounded with C ₁ = 1 μF	f = 217 Hz, V _(RIPPLE) = 200 mV _{pp}	-73		dB
SNR	Signal-to-noise ratio	V _{DD} = 5 V, P _O = 1 W, R _L = 8 Ω, A weighted noise		100		dB

TYPICAL CHARACTERISTICS

TABLE OF GRAPHS

			FIGURE
Efficiency		vs Output power	1, 2
P_D	Power dissipation	vs Output power	3, 4
	Supply current	vs Output power	5, 6
I_{DD}	Supply current	vs Supply voltage	7
$I_{(SD)}$	Shutdown current	vs Shutdown voltage	8
P_O	Output power	vs Load resistance	9, 10
		vs Supply voltage	11
THD+N	Total harmonic distortion plus noise	vs Output power	12, 13
		vs Frequency	14, 15, 16, 17
		vs Common-mode input voltage	18
K_{SVR}	Supply voltage rejection ratio	vs Frequency	19, 20, 21, 22, 23, 24, 25, 26, 27
	GSM power supply rejection	vs Time	28
		vs Frequency	29
K_{SVR}	Supply voltage rejection ratio	vs Common-mode input voltage	30, 31, 32
CMRR	Common-mode rejection ratio	vs Frequency	33
		vs Common-mode input voltage	34

TEST SET-UP FOR GRAPHS

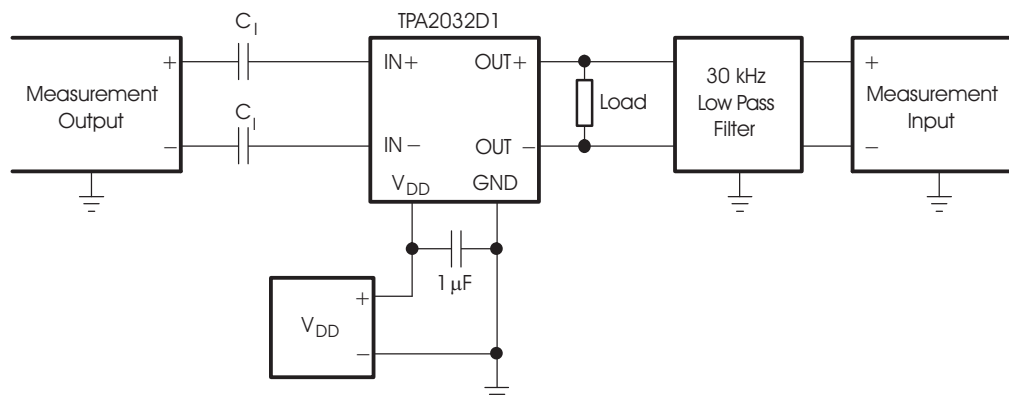

- (1) C_1 was shorted for any common-mode input voltage measurement. All other measurements were taken with a 1- μ F C_1 (unless otherwise noted).
- (2) A 33- μ H inductor was placed in series with the load resistor to emulate a small speaker for efficiency measurements.
- (3) The 30-kHz low-pass filter is required, even if the analyzer has an internal low-pass filter. An RC low-pass filter (100 Ω , 47-nF) is used on each output for the data sheet graphs.

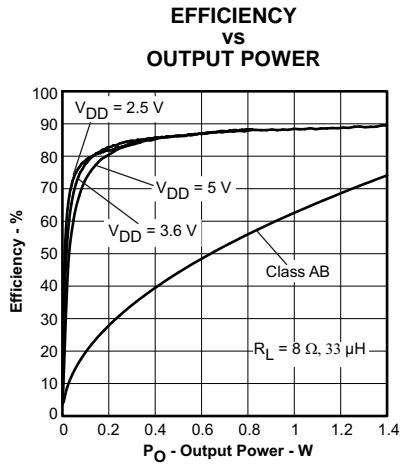

Figure 1.

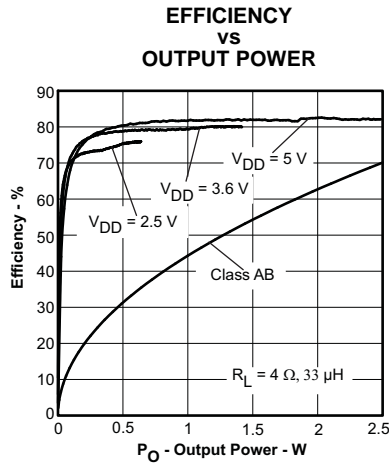

Figure 2.

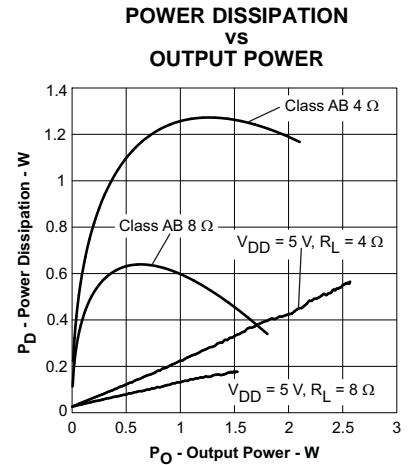

Figure 3.

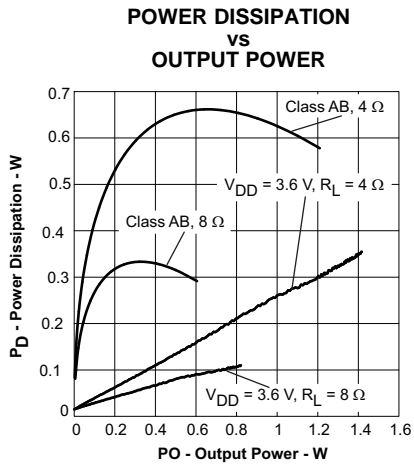

Figure 4.

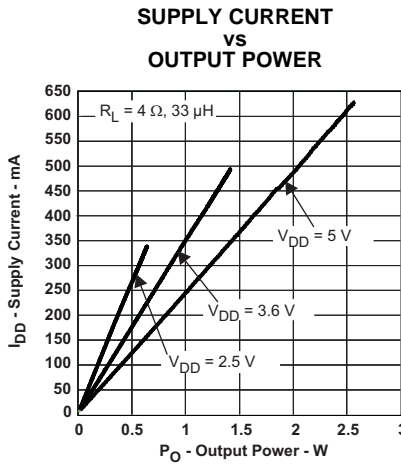

Figure 5.

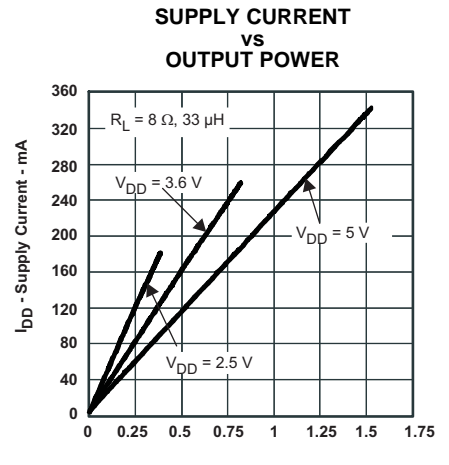

Figure 6.

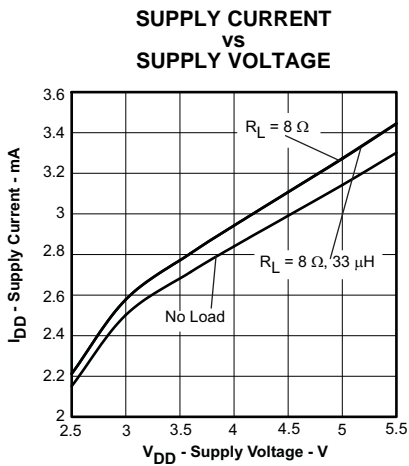

Figure 7.

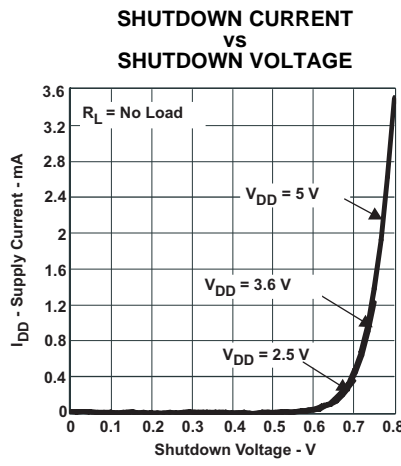

Figure 8.

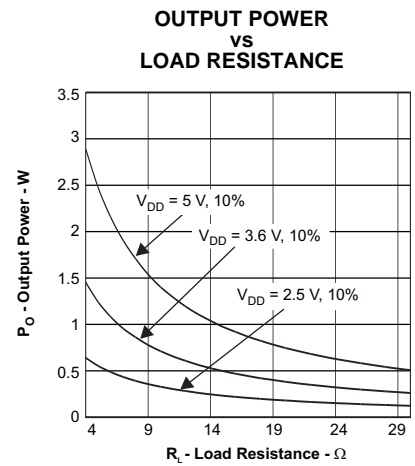

Figure 9.

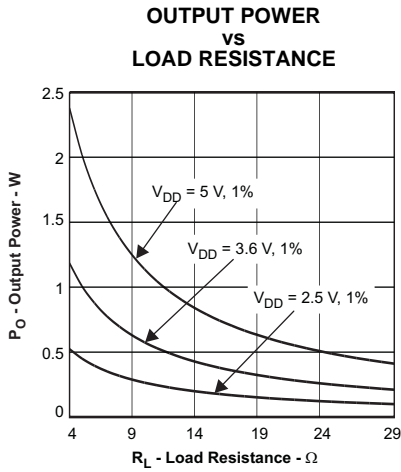

Figure 10.

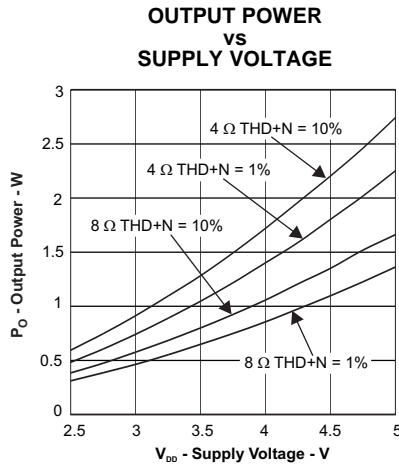

Figure 11.

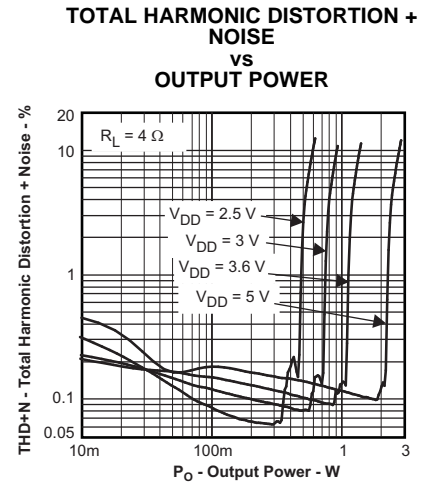

Figure 12.

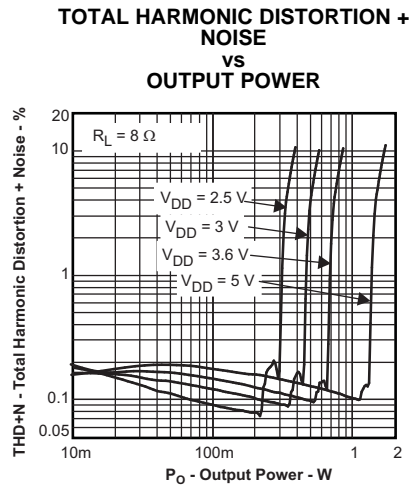

Figure 13.

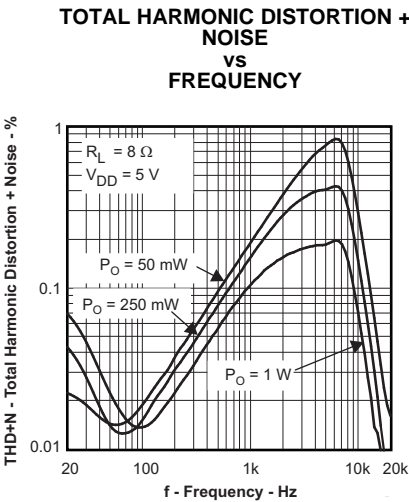

Figure 14.

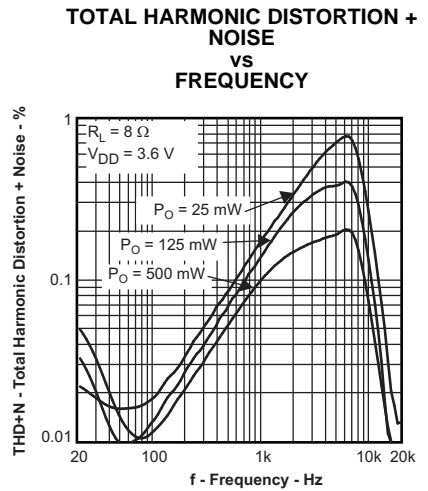

Figure 15.

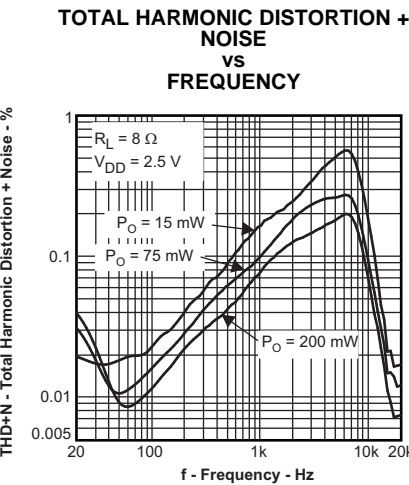

Figure 16.

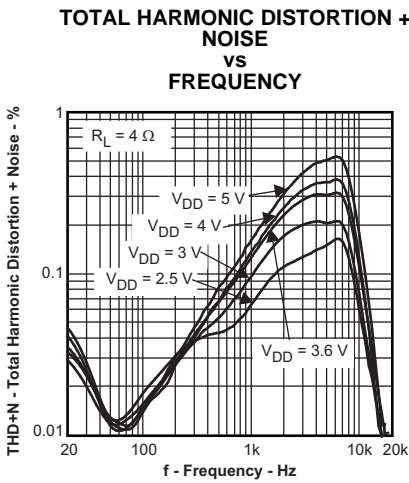

Figure 17.

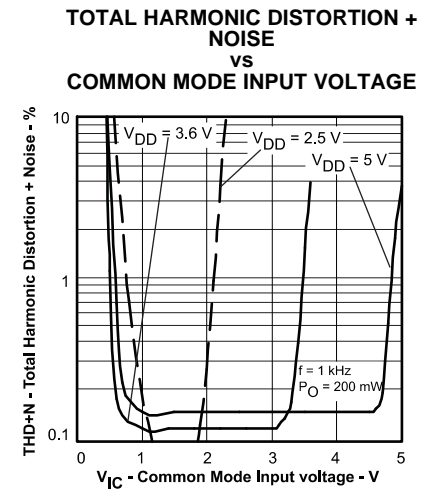

Figure 18.

**SUPPLY RIPPLE REJECTION RATIO
 vs
 FREQUENCY - TPA2032D1**

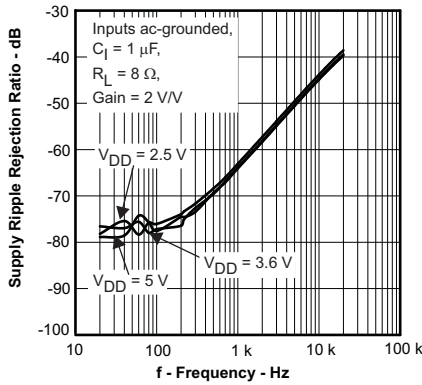

Figure 19.

**SUPPLY RIPPLE REJECTION RATIO
 vs
 FREQUENCY - TPA2033D1**

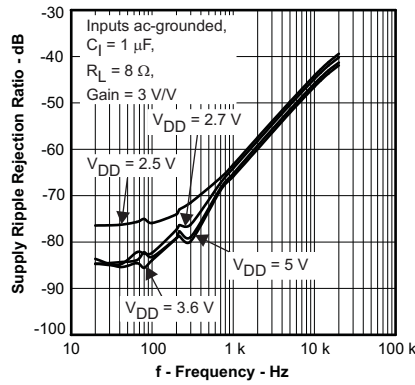

Figure 20.

**SUPPLY RIPPLE REJECTION RATIO
 vs
 FREQUENCY - TPA2034D1**

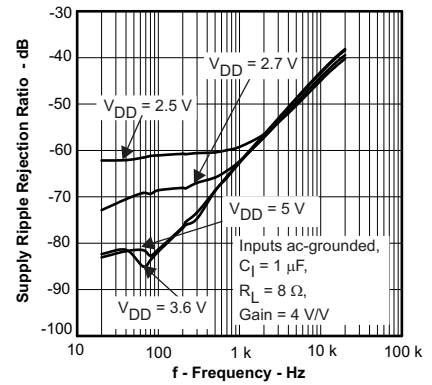

Figure 21.

**SUPPLY RIPPLE REJECTION RATIO
 vs
 FREQUENCY- TPA2032D1**

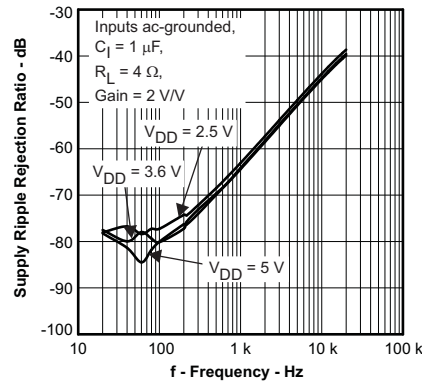

Figure 22.

**SUPPLY RIPPLE REJECTION RATIO
 vs
 FREQUENCY- TPA2033D1**

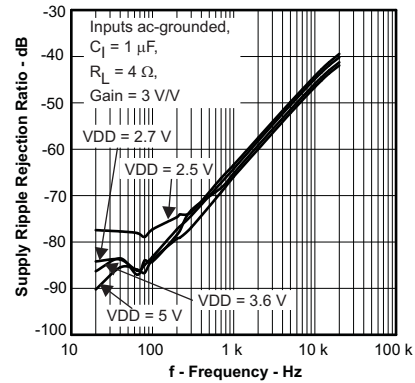

Figure 23.

**SUPPLY RIPPLE REJECTION RATIO
 vs
 FREQUENCY- TPA2034D1**

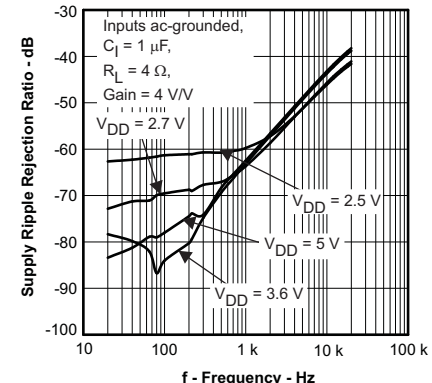

Figure 24.

**SUPPLY RIPPLE REJECTION RATIO
 vs
 FREQUENCY - TPA2032D1**

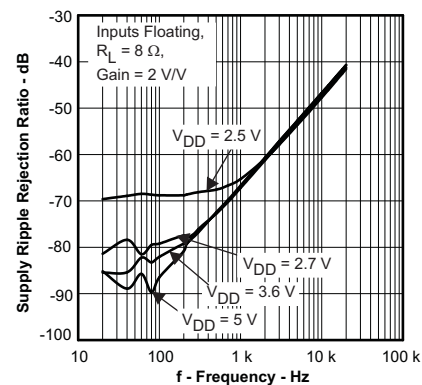

Figure 25.

**SUPPLY RIPPLE REJECTION RATIO
 vs
 FREQUENCY - TPA2033D1**

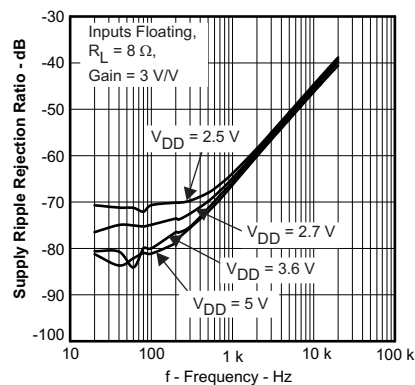

Figure 26.

**SUPPLY RIPPLE REJECTION RATIO
 vs
 FREQUENCY - TPA2034D1**

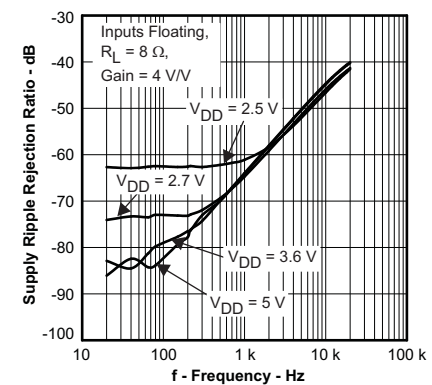

Figure 27.

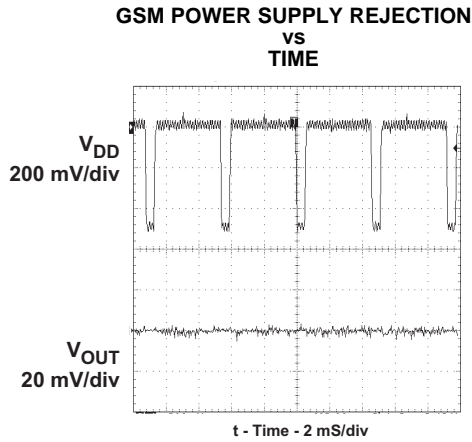

Figure 28.

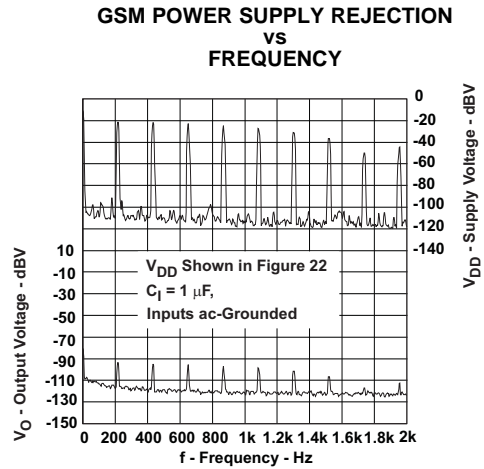

Figure 29.

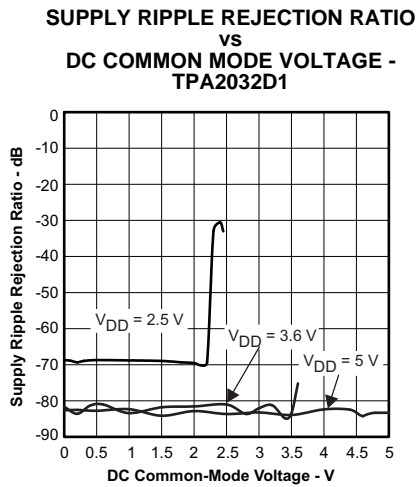

Figure 30.

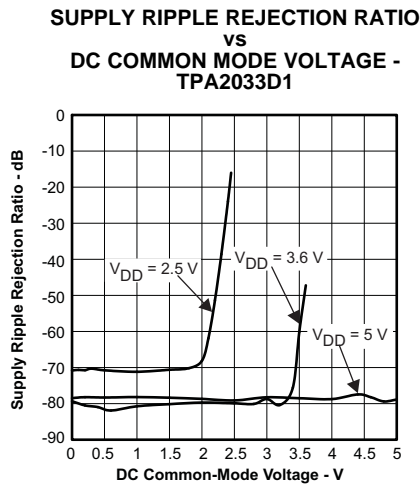

Figure 31.

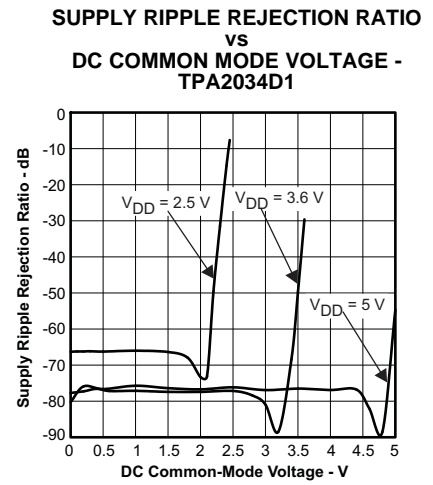

Figure 32.

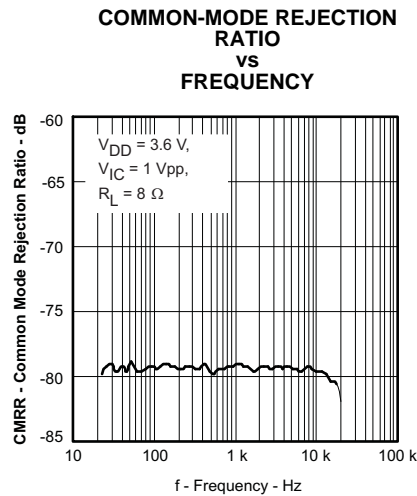

Figure 33.

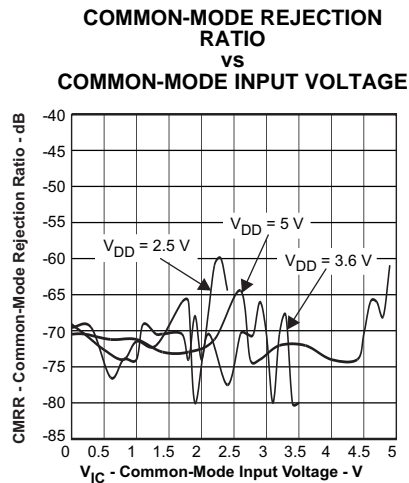

Figure 34.

APPLICATION INFORMATION

FULLY DIFFERENTIAL AMPLIFIER

The TPA2032D1 is a fully differential amplifier with differential inputs and outputs. The fully differential amplifier consists of a differential amplifier and a common-mode amplifier. The differential amplifier ensures that the amplifier outputs a differential voltage on the output that is equal to the differential input times the gain. The common-mode feedback ensures that the common-mode voltage at the output is biased around $V_{DD}/2$ regardless of the common-mode voltage at the input. The fully differential TPA2032D1 can still be used with a single-ended input; however, the TPA2032D1 should be used with differential inputs when in a noisy environment, like a wireless handset, to ensure maximum noise rejection.

Advantages of Fully Differential Amplifiers

- Input-coupling capacitors not required:
 - The fully differential amplifier allows the inputs to be biased at voltage other than mid-supply. The inputs of the TPA2032D1 can be biased anywhere within the common mode input voltage range listed in the Recommended Operating Conditions table. If the inputs are biased outside of that range, input-coupling capacitors are required.
- Midsupply bypass capacitor, $C_{(BYPASS)}$, not required:
 - The fully differential amplifier does not require a bypass capacitor. Any shift in the midsupply affects both positive and negative channels equally and cancels at the differential output.
- Better RF-immunity:
 - GSM handsets save power by turning on and shutting off the RF transmitter at a rate of 217 Hz. The transmitted signal is picked-up on input and output traces. The fully differential amplifier cancels the signal better than the typical audio amplifier.

COMPONENT SELECTION

Figure 35 shows the TPA2032D1 typical schematic with differential inputs, while Figure 36 shows the TPA2032D1 with differential inputs and input capacitors. Figure 37 shows the TPA2032D1 with a single-ended input.

Decoupling Capacitor (C_S)

The TPA2032D1 is a high-performance class-D audio amplifier that requires adequate power supply decoupling to ensure the efficiency is high and total harmonic distortion (THD) is low. For higher frequency transients, spikes, or digital hash on the line, a good low equivalent-series-resistance (ESR) ceramic capacitor, typically $1\mu\text{F}$, placed as close as possible to the device V_{DD} lead works best. Placing this decoupling capacitor close to the TPA2032D1 is very important for the efficiency of the class-D amplifier, because any resistance or inductance in the trace between the device and the capacitor can cause a loss in efficiency. For filtering lower-frequency noise signals, a $10\mu\text{F}$ or greater capacitor placed near the audio power amplifier would also help, but it is not required in most applications because of the high PSRR of this device. Typically, the smaller the capacitor's case size, the lower the inductance and the closer it can be placed to the TPA2032D1.

Input Capacitors (C_I)

The TPA2032D1 does not require input coupling capacitors if the design uses a differential source that is biased within the common-mode input voltage range. That voltage range is listed in the Recommended Operating Conditions table. If the input signal is not biased within the recommended common-mode input range, such as in needing to use the input as a high pass filter, shown in Figure 36, or if using a single-ended source, shown in Figure 37, input coupling capacitors are required. The same value capacitors should be used on both IN+ and IN– for best pop performance.

$$f_c = \frac{1}{(2\pi R_I C_I)} \quad (1)$$

The value of the input capacitor is important to consider as it directly affects the bass (low frequency) performance of the circuit. Speaker response may also be taken into consideration when setting the corner frequency using input capacitors.

APPLICATION INFORMATION (continued)

Equation 2 is reconfigured to solve for the input coupling capacitance.

$$C_I = \frac{1}{(2\pi R_I f_c)} \quad (2)$$

If the corner frequency is within the audio band, the capacitors should have a tolerance of $\pm 10\%$ or better, because any mismatch in capacitance causes an impedance mismatch at the corner frequency and below.

For a flat low-frequency response, use large input coupling capacitors (1 μF or larger).

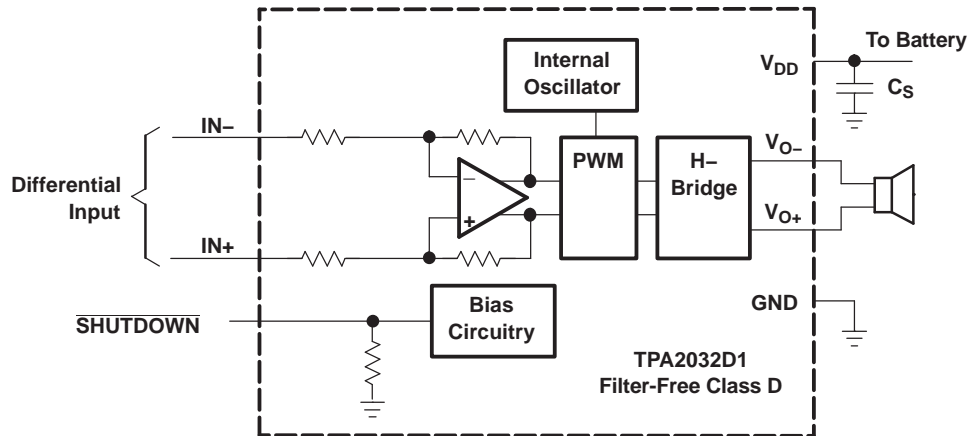

Figure 35. Typical TPA2032D1 Application Schematic With Differential Input for a Wireless Phone

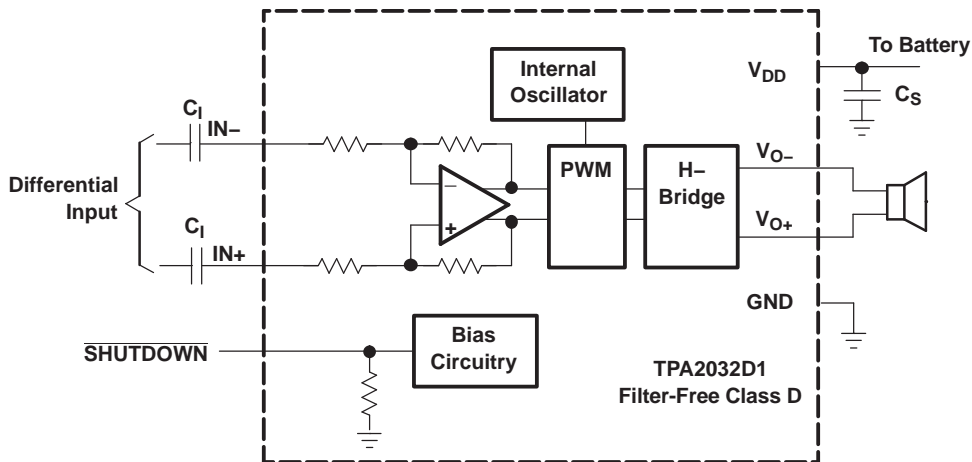

Figure 36. TPA2032D1 Application Schematic With Differential Input and Input Capacitors

APPLICATION INFORMATION (continued)

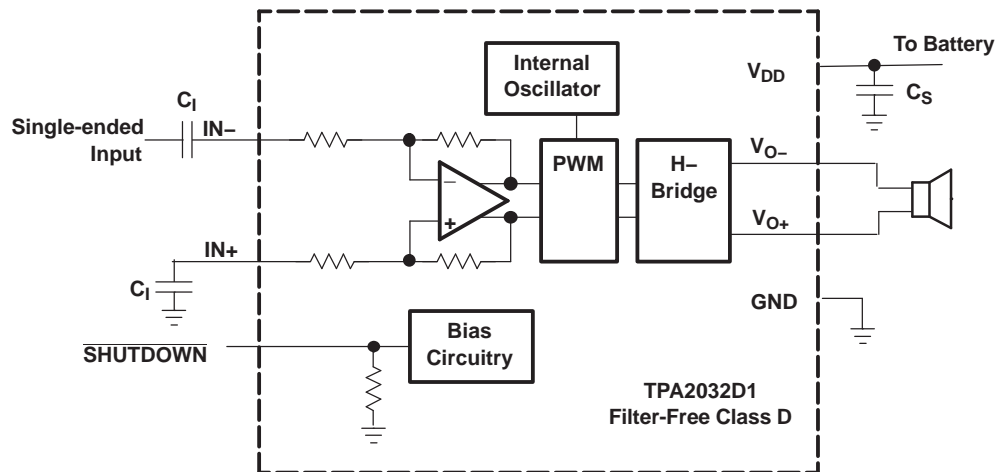

Figure 37. TPA2032D1 Application Schematic With Single-Ended Input

BOARD LAYOUT

In making the pad size for the WCSP balls, it is recommended that the layout use nonsolder mask defined (NSMD) land. With this method, the solder mask opening is made larger than the desired land area, and the opening size is defined by the copper pad width. [Figure 38](#) and [Table 1](#) show the appropriate diameters for a WCSP layout. The TPA2032D1 evaluation module (EVM) layout is shown in the next section as a layout example.

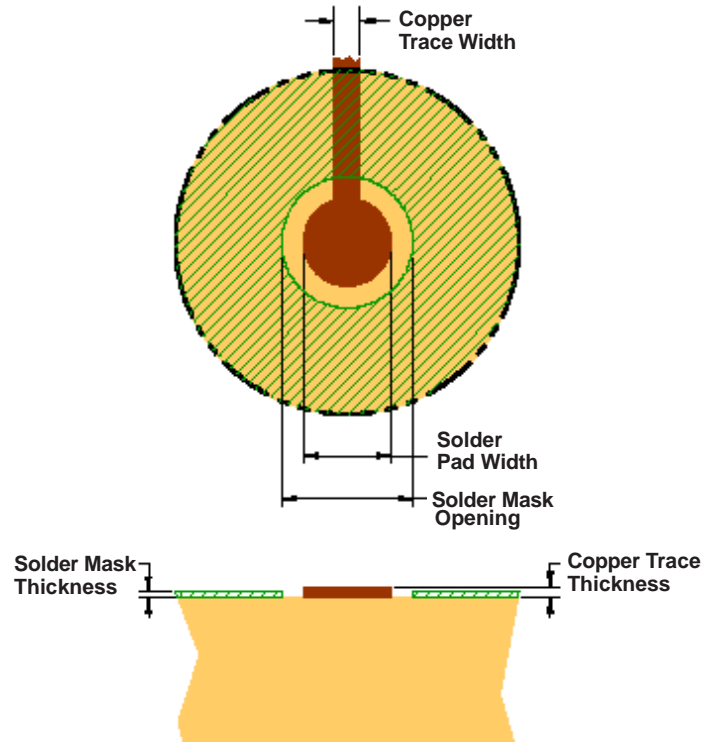

Figure 38. Land Pattern Dimensions

APPLICATION INFORMATION (continued)

Table 1. Land Pattern Dimensions

SOLDER PAD DEFINITIONS	COPPER PAD	SOLDER MASK OPENING	COPPER THICKNESS	STENCIL OPENING	STENCIL THICKNESS
Nonsolder mask defined (NSMD)	275 μm (+0.0, -25 μm)	375 μm (+0.0, -25 μm)	1 oz max (32 μm)	275 μm x 275 μm Sq. (rounded corners)	125 μm thick

NOTES:

1. Circuit traces from NSMD defined PWB lands should be 75 μm to 100 μm wide in the exposed area inside the solder mask opening. Wider trace widths reduce device stand off and impact reliability.
2. Recommended solder paste is Type 3 or Type 4.
3. Best reliability results are achieved when the PWB laminate glass transition temperature is above the operating range of the intended application.
4. For a PWB using a Ni/Au surface finish, the gold thickness should be less 0.5 μm to avoid a reduction in thermal fatigue performance.
5. Solder mask thickness should be less than 20 μm on top of the copper circuit pattern.
6. Best solder stencil performance is achieved using laser-cut stencils with electro polishing. Use of chemically etched stencils results in inferior solder paste volume control.
7. Trace routing away from WCSP device should be balanced in X and Y directions to avoid unintentional component movement due to solder wetting forces.

Component Location

Place all the external components very close to the TPA2032D1. Placing the decoupling capacitor, C_S , close to the TPA2032D1 is important for the efficiency of the class-D amplifier. Any resistance or inductance in the trace between the device and the capacitor can cause a loss in efficiency.

Trace Width

Recommended trace width at the solder balls is 75 μm to 100 μm to prevent solder wicking onto wider PCB traces. [Figure 39](#) shows the layout of the TPA2032D1 evaluation module (EVM).

For high current pins (V_{DD} , GND V_{O+} , and V_{O-}) of the TPA2032D1, use 100- μm trace widths at the solder balls and at least 500- μm PCB traces to ensure proper performance and output power for the device.

For input pins (IN $-$, IN $+$, and $\overline{\text{SHUTDOWN}}$) of the TPA2032D1, use 75- μm to 100- μm trace widths at the solder balls. IN $-$ and IN $+$ traces need to run side-by-side to maximize common-mode noise cancellation.

WHEN TO USE AN OUTPUT FILTER

Design the TPA2032D1 without an output filter if the traces from the amplifier to the speaker are short. Wireless handsets and PDAs are great applications for this class-D amplifier to be used without an output filter.

The TPA2032D1 passed FCC- and CE-radiated emissions testing with no shielding with speaker trace wires 100 mm long or less. For longer speaker trace wires, a ferrite bead can often be used in the design if failing radiated emissions testing without an LC filter; and, the frequency-sensitive circuit is greater than 1 MHz. If choosing a ferrite bead, choose one with high impedance at high frequencies, but very low impedance at low frequencies. The selection must also take into account the currents flowing through the ferrite bead. Ferrites can begin to lose effectiveness at much lower than rated current values. Please see the EVM User's Guide for components used successfully by TI.

Figure 40 shows a typical ferrite-bead output filter.

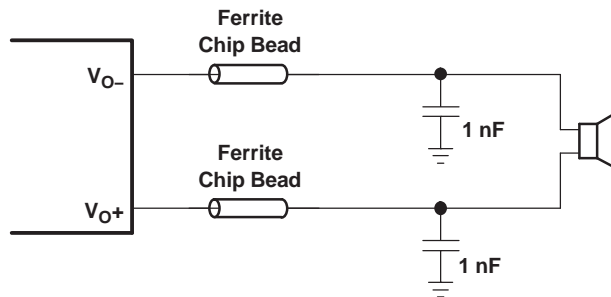

Figure 40. Typical Ferrite Chip Bead Filter

PACKAGING INFORMATION

Orderable Device	Status (1)	Package Type	Package Drawing	Pins	Package Qty	Eco Plan (2)	Lead finish/ Ball material (6)	MSL Peak Temp (3)	Op Temp (°C)	Device Marking (4/5)	Samples
TPA2032D1YZFR	ACTIVE	DSBGA	YZF	9	3000	RoHS & Green	SNAGCU	Level-1-260C-UNLIM	-40 to 85	BPKS	Samples
TPA2032D1YZFT	ACTIVE	DSBGA	YZF	9	250	RoHS & Green	SNAGCU	Level-1-260C-UNLIM	-40 to 85	BPKS	Samples
TPA2033D1YZFR	ACTIVE	DSBGA	YZF	9	3000	RoHS & Green	SNAGCU	Level-1-260C-UNLIM	-40 to 85	BPY	Samples
TPA2034D1YZFR	ACTIVE	DSBGA	YZF	9	3000	RoHS & Green	SNAGCU	Level-1-260C-UNLIM	-40 to 85	BPZ	Samples
TPA2034D1YZFT	ACTIVE	DSBGA	YZF	9	250	RoHS & Green	SNAGCU	Level-1-260C-UNLIM	-40 to 85	BPZ	Samples

(1) The marketing status values are defined as follows:

ACTIVE: Product device recommended for new designs.

LIFEBUY: TI has announced that the device will be discontinued, and a lifetime-buy period is in effect.

NRND: Not recommended for new designs. Device is in production to support existing customers, but TI does not recommend using this part in a new design.

PREVIEW: Device has been announced but is not in production. Samples may or may not be available.

OBSELETE: TI has discontinued the production of the device.

(2) **RoHS:** TI defines "RoHS" to mean semiconductor products that are compliant with the current EU RoHS requirements for all 10 RoHS substances, including the requirement that RoHS substance do not exceed 0.1% by weight in homogeneous materials. Where designed to be soldered at high temperatures, "RoHS" products are suitable for use in specified lead-free processes. TI may reference these types of products as "Pb-Free".

RoHS Exempt: TI defines "RoHS Exempt" to mean products that contain lead but are compliant with EU RoHS pursuant to a specific EU RoHS exemption.

Green: TI defines "Green" to mean the content of Chlorine (Cl) and Bromine (Br) based flame retardants meet JS709B low halogen requirements of <=1000ppm threshold. Antimony trioxide based flame retardants must also meet the <=1000ppm threshold requirement.

(3) MSL, Peak Temp. - The Moisture Sensitivity Level rating according to the JEDEC industry standard classifications, and peak solder temperature.

(4) There may be additional marking, which relates to the logo, the lot trace code information, or the environmental category on the device.

(5) Multiple Device Markings will be inside parentheses. Only one Device Marking contained in parentheses and separated by a "~" will appear on a device. If a line is indented then it is a continuation of the previous line and the two combined represent the entire Device Marking for that device.

(6) Lead finish/Ball material - Orderable Devices may have multiple material finish options. Finish options are separated by a vertical ruled line. Lead finish/Ball material values may wrap to two lines if the finish value exceeds the maximum column width.

Important Information and Disclaimer: The information provided on this page represents TI's knowledge and belief as of the date that it is provided. TI bases its knowledge and belief on information provided by third parties, and makes no representation or warranty as to the accuracy of such information. Efforts are underway to better integrate information from third parties. TI has taken and continues to take reasonable steps to provide representative and accurate information but may not have conducted destructive testing or chemical analysis on incoming materials and chemicals. TI and TI suppliers consider certain information to be proprietary, and thus CAS numbers and other limited information may not be available for release.

In no event shall TI's liability arising out of such information exceed the total purchase price of the TI part(s) at issue in this document sold by TI to Customer on an annual basis.

TAPE AND REEL INFORMATION

QUADRANT ASSIGNMENTS FOR PIN 1 ORIENTATION IN TAPE

*All dimensions are nominal

Device	Package Type	Package Drawing	Pins	SPQ	Reel Diameter (mm)	Reel Width W1 (mm)	A0 (mm)	B0 (mm)	K0 (mm)	P1 (mm)	W (mm)	Pin1 Quadrant
TPA2032D1YZFR	DSBGA	YZF	9	3000	180.0	8.4	1.65	1.65	0.81	4.0	8.0	Q1
TPA2032D1YZFT	DSBGA	YZF	9	250	180.0	8.4	1.65	1.65	0.81	4.0	8.0	Q1
TPA2033D1YZFR	DSBGA	YZF	9	3000	180.0	8.4	1.65	1.65	0.81	4.0	8.0	Q1
TPA2034D1YZFR	DSBGA	YZF	9	3000	180.0	8.4	1.65	1.65	0.81	4.0	8.0	Q1
TPA2034D1YZFT	DSBGA	YZF	9	250	180.0	8.4	1.65	1.65	0.81	4.0	8.0	Q1

TAPE AND REEL BOX DIMENSIONS



*All dimensions are nominal

Device	Package Type	Package Drawing	Pins	SPQ	Length (mm)	Width (mm)	Height (mm)
TPA2032D1YZFR	DSBGA	YZF	9	3000	182.0	182.0	20.0
TPA2032D1YZFT	DSBGA	YZF	9	250	182.0	182.0	20.0
TPA2033D1YZFR	DSBGA	YZF	9	3000	182.0	182.0	20.0
TPA2034D1YZFR	DSBGA	YZF	9	3000	182.0	182.0	20.0
TPA2034D1YZFT	DSBGA	YZF	9	250	182.0	182.0	20.0

EXAMPLE BOARD LAYOUT

YZF0009

DSBGA - 0.625 mm max height

DIE SIZE BALL GRID ARRAY

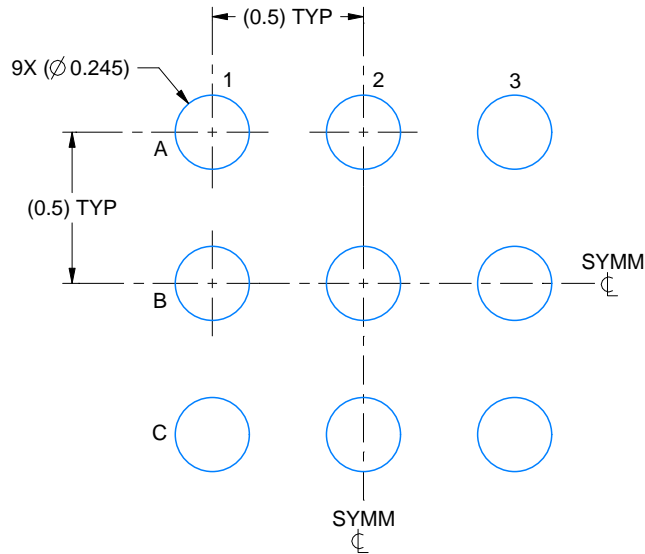

LAND PATTERN EXAMPLE
EXPOSED METAL SHOWN
SCALE: 40X

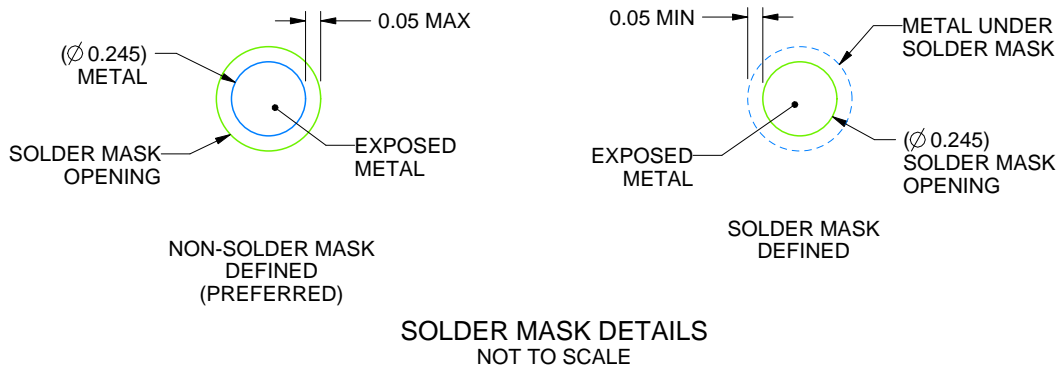

SOLDER MASK DETAILS
NOT TO SCALE

4219558/A 10/2018

NOTES: (continued)

- Final dimensions may vary due to manufacturing tolerance considerations and also routing constraints. See Texas Instruments Literature No. SNVA009 (www.ti.com/lit/snva009).

EXAMPLE STENCIL DESIGN

YZF0009

DSBGA - 0.625 mm max height

DIE SIZE BALL GRID ARRAY

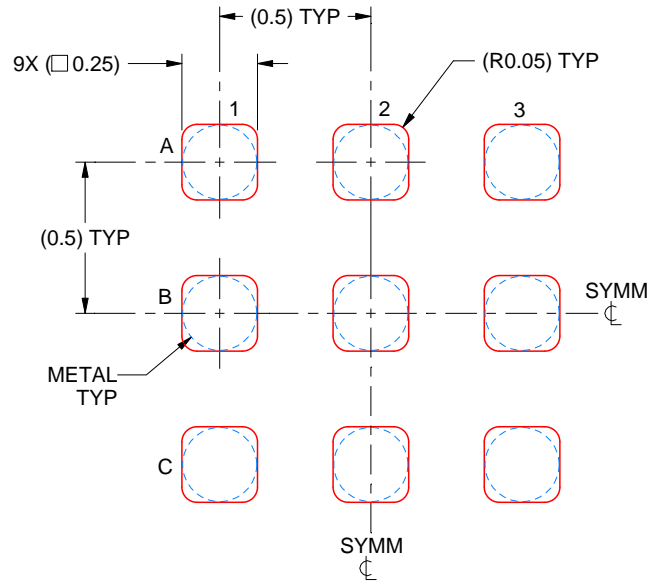

SOLDER PASTE EXAMPLE
BASED ON 0.1 mm THICK STENCIL
SCALE: 40X

4219558/A 10/2018

NOTES: (continued)

4. Laser cutting apertures with trapezoidal walls and rounded corners may offer better paste release.

IMPORTANT NOTICE AND DISCLAIMER

TI PROVIDES TECHNICAL AND RELIABILITY DATA (INCLUDING DATA SHEETS), DESIGN RESOURCES (INCLUDING REFERENCE DESIGNS), APPLICATION OR OTHER DESIGN ADVICE, WEB TOOLS, SAFETY INFORMATION, AND OTHER RESOURCES "AS IS" AND WITH ALL FAULTS, AND DISCLAIMS ALL WARRANTIES, EXPRESS AND IMPLIED, INCLUDING WITHOUT LIMITATION ANY IMPLIED WARRANTIES OF MERCHANTABILITY, FITNESS FOR A PARTICULAR PURPOSE OR NON-INFRINGEMENT OF THIRD PARTY INTELLECTUAL PROPERTY RIGHTS.

These resources are intended for skilled developers designing with TI products. You are solely responsible for (1) selecting the appropriate TI products for your application, (2) designing, validating and testing your application, and (3) ensuring your application meets applicable standards, and any other safety, security, regulatory or other requirements.

These resources are subject to change without notice. TI grants you permission to use these resources only for development of an application that uses the TI products described in the resource. Other reproduction and display of these resources is prohibited. No license is granted to any other TI intellectual property right or to any third party intellectual property right. TI disclaims responsibility for, and you will fully indemnify TI and its representatives against, any claims, damages, costs, losses, and liabilities arising out of your use of these resources.

TI's products are provided subject to [TI's Terms of Sale](#) or other applicable terms available either on [ti.com](https://www.ti.com) or provided in conjunction with such TI products. TI's provision of these resources does not expand or otherwise alter TI's applicable warranties or warranty disclaimers for TI products.

TI objects to and rejects any additional or different terms you may have proposed.

Mailing Address: Texas Instruments, Post Office Box 655303, Dallas, Texas 75265
Copyright © 2024, Texas Instruments Incorporated