

TSB43AB21A/TSB43AB21AI

Integrated 1394a-2000 OHCI PHY/Link-Layer Controller

Data Manual

NOTE

Designing with this device may require extensive support. Before incorporating this device into a design, customers should contact TI or an Authorized TI Distributor.

Contents

<i>Section</i>	<i>Title</i>	<i>Page</i>
1	Introduction	1-1
1.1	Description	1-1
1.2	Features	1-3
1.3	Related Documents	1-4
1.4	Trademarks	1-4
1.5	Ordering Information	1-4
2	Terminal Descriptions	2-1
3	TSB43AB21A 1394 OHCI Controller Programming Model	3-1
3.1	PCI Configuration Registers	3-3
3.2	Vendor ID Register	3-3
3.3	Device ID Register	3-4
3.4	Command Register	3-4
3.5	Status Register	3-5
3.6	Class Code and Revision ID Register	3-6
3.7	Latency Timer and Class Cache Line Size Register	3-6
3.8	Header Type and BIST Register	3-7
3.9	OHCI Base Address Register	3-7
3.10	TI Extension Base Address Register	3-8
3.11	CardBus CIS Base Address Register	3-9
3.12	CardBus CIS Pointer Register	3-10
3.13	Subsystem Identification Register	3-11
3.14	Power Management Capabilities Pointer Register	3-11
3.15	Interrupt Line and Pin Register	3-12
3.16	MIN_GNT and MAX_LAT Register	3-12
3.17	OHCI Control Register	3-13
3.18	Capability ID and Next Item Pointer Registers	3-13
3.19	Power Management Capabilities Register	3-14
3.20	Power Management Control and Status Register	3-15
3.21	Power Management Extension Registers	3-15
3.22	PCI PHY Control Register	3-16
3.23	Miscellaneous Configuration Register	3-17
3.24	Link Enhancement Control Register	3-18
3.25	Subsystem Access Register	3-19
3.26	GPIO Control Register	3-20
4	OHCI Registers	4-1
4.1	OHCI Version Register	4-4
4.2	GUID ROM Register	4-5

4.3	Asynchronous Transmit Retries Register	4-6
4.4	CSR Data Register	4-6
4.5	CSR Compare Register	4-7
4.6	CSR Control Register	4-7
4.7	Configuration ROM Header Register	4-8
4.8	Bus Identification Register	4-8
4.9	Bus Options Register	4-9
4.10	GUID High Register	4-10
4.11	GUID Low Register	4-10
4.12	Configuration ROM Mapping Register	4-11
4.13	Posted Write Address Low Register	4-11
4.14	Posted Write Address High Register	4-12
4.15	Vendor ID Register	4-12
4.16	Host Controller Control Register	4-13
4.17	Self-ID Buffer Pointer Register	4-14
4.18	Self-ID Count Register	4-15
4.19	Isochronous Receive Channel Mask High Register	4-16
4.20	Isochronous Receive Channel Mask Low Register	4-17
4.21	Interrupt Event Register	4-18
4.22	Interrupt Mask Register	4-20
4.23	Isochronous Transmit Interrupt Event Register	4-22
4.24	Isochronous Transmit Interrupt Mask Register	4-23
4.25	Isochronous Receive Interrupt Event Register	4-23
4.26	Isochronous Receive Interrupt Mask Register	4-24
4.27	Initial Bandwidth Available Register	4-24
4.28	Initial Channels Available High Register	4-25
4.29	Initial Channels Available Low Register	4-25
4.30	Fairness Control Register	4-26
4.31	Link Control Register	4-27
4.32	Node Identification Register	4-28
4.33	PHY Layer Control Register	4-29
4.34	Isochronous Cycle Timer Register	4-30
4.35	Asynchronous Request Filter High Register	4-31
4.36	Asynchronous Request Filter Low Register	4-33
4.37	Physical Request Filter High Register	4-34
4.38	Physical Request Filter Low Register	4-36
4.39	Physical Upper Bound Register (Optional Register)	4-36
4.40	Asynchronous Context Control Register	4-37
4.41	Asynchronous Context Command Pointer Register	4-38
4.42	Isochronous Transmit Context Control Register	4-39
4.43	Isochronous Transmit Context Command Pointer Register	4-40
4.44	Isochronous Receive Context Control Register	4-40
4.45	Isochronous Receive Context Command Pointer Register	4-42
4.46	Isochronous Receive Context Match Register	4-43

5	TI Extension Registers	5-1
5.1	DV and MPEG2 Timestamp Enhancements	5-1
5.2	Isochronous Receive Digital Video Enhancements	5-2
5.3	Isochronous Receive Digital Video Enhancements Register	5-2
5.4	Link Enhancement Register	5-4
5.5	Timestamp Offset Register	5-5
6	Serial EEPROM Interface	6-1
7	PHY Register Configuration	7-1
7.1	Base Registers	7-1
7.2	Port Status Register	7-4
7.3	Vendor Identification Register	7-5
7.4	Vendor-Dependent Register	7-6
7.5	Power-Class Programming	7-7
8	Application Information	8-1
8.1	PHY Port Cable Connection	8-1
8.2	Crystal Selection	8-2
8.3	Bus Reset	8-3
8.4	EMI Guidelines	8-4
9	Electrical Characteristics	9-1
9.1	Absolute Maximum Ratings Over Operating Temperature Ranges .	9-1
9.2	Recommended Operating Conditions	9-2
9.3	Electrical Characteristics Over Recommended Operating Conditions	9-3
9.4	Electrical Characteristics Over Recommended Ranges of Operating Conditions	9-4
9.4.1	Device	9-4
9.4.2	Driver	9-4
9.4.3	Receiver	9-5
9.5	Thermal Characteristics	9-5
9.6	Switching Characteristics for PHY Port Interface	9-5
9.7	Operating, Timing, and Switching Characteristics of XI	9-5
9.8	Switching Characteristics for PCI Interface	9-5
9.8.1	CardBus PC Card Clock Specifications	9-6
9.8.2	3.3-V Timing Parameters	9-6
10	Mechanical Information	10-1

List of Illustrations

<i>Figure</i>	<i>Title</i>	<i>Page</i>
2-1	TSB43AB21A Terminal Assignments	2-2
3-1	TSB43AB21A Block Diagram	3-2
8-1	TP Cable Connections	8-1
8-2	Typical Compliant DC Isolated Outer Shield Termination	8-2
8-3	Non-DC Isolated Outer Shield Termination	8-2
8-4	Load Capacitance for the TSB43AB21A PHY	8-3
8-5	Recommended Crystal and Capacitor Layout	8-3
9-1	Test Load Diagram	9-4
9-2	CardBus PC Card Clock Waveform	9-6

List of Tables

<i>Table</i>	<i>Title</i>	<i>Page</i>
2-1	Signals Sorted by Terminal Number	2-3
2-2	Signal Names Sorted Alphanumerically to Terminal Number	2-4
2-3	PCI System Terminals	2-5
2-4	PCI Address and Data Terminals	2-5
2-5	PCI Interface Control Terminals	2-6
2-6	Miscellaneous Terminals	2-7
2-7	Physical Layer Terminals	2-8
2-8	Power Supply Terminals	2-9
3-1	Bit Field Access Tag Descriptions	3-1
3-2	PCI Configuration Register Map	3-3
3-3	Command Register Description	3-4
3-4	Status Register Description	3-5
3-5	Class Code and Revision ID Register Description	3-6
3-6	Latency Timer and Class Cache Line Size Register Description	3-6
3-7	Header Type and BIST Register Description	3-7
3-8	OHCI Base Address Register Description	3-7
3-9	TI Base Address Register Description	3-8
3-10	CardBus CIS Base Address Register Description	3-9
3-11	CardBus CIS Pointer Register Description	3-10
3-12	Subsystem Identification Register Description	3-11
3-13	Interrupt Line and Pin Registers Description	3-12

3-14	MIN_GNT and MAX_LAT Register Description	3-12
3-15	OHCI Control Register Description	3-13
3-16	Capability ID and Next Item Pointer Registers Description	3-13
3-17	Power Management Capabilities Register Description	3-14
3-18	Power Management Control and Status Register Description	3-15
3-19	Power Management Extension Registers Description	3-15
3-20	PCI PHY Control Register	3-16
3-21	Miscellaneous Configuration Register	3-17
3-22	Link Enhancement Control Register Description	3-18
3-23	Subsystem Access Register Description	3-19
3-24	General-Purpose Input/Output Control Register Description	3-20
4-1	OHCI Register Map	4-1
4-2	OHCI Version Register Description	4-4
4-3	GUID ROM Register Description	4-5
4-4	Asynchronous Transmit Retries Register Description	4-6
4-5	CSR Control Register Description	4-7
4-6	Configuration ROM Header Register Description	4-8
4-7	Bus Options Register Description	4-9
4-8	Configuration ROM Mapping Register Description	4-11
4-9	Posted Write Address Low Register Description	4-11
4-10	Posted Write Address High Register Description	4-12
4-11	Host Controller Control Register Description	4-13
4-12	Self-ID Count Register Description	4-15
4-13	Isochronous Receive Channel Mask High Register Description	4-16
4-14	Isochronous Receive Channel Mask Low Register Description	4-17
4-15	Interrupt Event Register Description	4-18
4-16	Interrupt Mask Register Description	4-20
4-17	Isochronous Transmit Interrupt Event Register Description	4-22
4-18	Isochronous Receive Interrupt Event Register Description	4-23
4-19	Initial Bandwidth Available Register Description	4-24
4-20	Initial Channels Available High Register Description	4-25
4-21	Initial Channels Available Low Register Description	4-25
4-22	Fairness Control Register Description	4-26
4-23	Link Control Register Description	4-27
4-24	Node Identification Register Description	4-28
4-25	PHY Control Register Description	4-29
4-26	Isochronous Cycle Timer Register Description	4-30
4-27	Asynchronous Request Filter High Register Description	4-31
4-28	Asynchronous Request Filter Low Register Description	4-33
4-29	Physical Request Filter High Register Description	4-34
4-30	Physical Request Filter Low Register Description	4-36
4-31	Asynchronous Context Control Register Description	4-37
4-32	Asynchronous Context Command Pointer Register Description	4-38
4-33	Isochronous Transmit Context Control Register Description	4-39

4-34	Isochronous Receive Context Control Register Description	4-40
4-35	Isochronous Receive Context Match Register Description	4-43
5-1	TI Extension Register Map	5-1
5-2	Isochronous Receive Digital Video Enhancements Register Description	5-2
5-3	Link Enhancement Register Description	5-4
5-4	Timestamp Offset Register Description	5-5
6-1	Registers and Bits Loadable Through Serial EEPROM	6-1
6-2	Serial EEPROM Map	6-2
7-1	Base Register Configuration	7-1
7-2	Base Register Field Descriptions	7-2
7-3	Page 0 (Port Status) Register Configuration	7-4
7-4	Page 0 (Port Status) Register Field Descriptions	7-4
7-5	Page 1 (Vendor ID) Register Configuration	7-5
7-6	Page 1 (Vendor ID) Register Field Descriptions	7-5
7-7	Page 7 (Vendor-Dependent) Register Configuration	7-6
7-8	Page 7 (Vendor-Dependent) Register Field Descriptions	7-6
7-9	Power Class Descriptions	7-7

1 Introduction

This chapter provides an overview of the Texas Instruments TSB43AB21A device and its features.

1.1 Description

The Texas Instruments TSB43AB21A device is an integrated 1394a-2000 OHCI PHY/link-layer controller (LLC) device that is fully compliant with the *PCI Local Bus Specification*, the *PCI Bus Power Management Interface Specification* (Revision 1.1), IEEE Std 1394-1995, IEEE Std 1394a-2000, and the *1394 Open Host Controller Interface Specification* (Release 1.1). It is capable of transferring data between the 33-MHz PCI bus and the 1394 bus at 100M bits/s, 200M bits/s, and 400M bits/s. The TSB43AB21A device provides one 1394 port. The TSB43AB21A device also supports the IEEE Std 1394a-2000 power-down features for battery-operated applications and arbitration enhancements.

As required by the *1394 Open Host Controller Interface Specification* (OHCI) and IEEE Std 1394a-2000, internal control registers are memory-mapped and nonprefetchable. The PCI configuration header is accessed through configuration cycles specified by PCI, and it provides plug-and-play (PnP) compatibility. Furthermore, the TSB43AB21A device is compliant with the *PCI Bus Power Management Interface Specification* as specified by the *PC 2001 Design Guide* requirements. The TSB43AB21A device supports the D0, D1, D2, and D3 power states.

The TSB43AB21A design provides PCI bus master bursting, and it is capable of transferring a cacheline of data at 132M bytes/s after connection to the memory controller. Because PCI latency can be large, deep FIFOs are provided to buffer the 1394 data.

The TSB43AB21A device provides physical write posting buffers and a highly-tuned physical data path for SBP-2 performance. The TSB43AB21A device also provides multiple isochronous contexts, multiple cacheline burst transfers, and advanced internal arbitration.

An advanced CMOS process achieves low power consumption and allows the TSB43AB21A device to operate at PCI clock rates up to 33 MHz.

The TSB43AB21A PHY-layer provides the digital and analog transceiver functions needed to implement a single-port node in a cable-based 1394 network. The cable port incorporates two differential line transceivers. The transceivers include circuitry to monitor the line conditions as needed for determining connection status, for initialization and arbitration, and for packet reception and transmission.

The TSB43AB21A PHY-layer requires only an external 24.576-MHz crystal as a reference for the cable ports. An external clock may be provided instead of a crystal. An internal oscillator drives an internal phase-locked loop (PLL), which generates the required 393.216-MHz reference signal. This reference signal is internally divided to provide the clock signals that control transmission of the outbound encoded strobe and data information. A 49.152-MHz clock signal is supplied to the integrated LLC for synchronization and is used for resynchronization of the received data.

Data bits to be transmitted through the cable port are received from the integrated LLC and are latched internally in synchronization with the 49.152-MHz system clock. These bits are combined serially, encoded, and transmitted at 98.304M, 196.608M, or 393.216M bits/s (referred to as S100, S200, or S400 speeds, respectively) as the outbound data-strobe information stream. During transmission, the encoded data information is transmitted differentially on the twisted-pair B (TPB) cable pair, and the encoded strobe information is transmitted differentially on the twisted-pair A (TPA) cable pair.

During packet reception, the TPA and TPB transmitters of the receiving cable port are disabled, and the receivers for that port are enabled. The encoded data information is received on the TPA cable pair, and the encoded strobe information is received on the TPB cable pair. The received data-strobe information is decoded to recover the receive clock signal and the serial data bits. The serial data bits are resynchronized to the local 49.152-MHz system clock and sent to the integrated LLC.

Both the TPA and TPB cable interfaces incorporate differential comparators to monitor the line states during initialization and arbitration. The outputs of these comparators are used by the internal logic to determine the

arbitration status. The TPA channel monitors the incoming cable common-mode voltage. The value of this common-mode voltage is used during arbitration to set the speed of the next packet transmission. In addition, the TPB channel monitors the incoming cable common-mode voltage on the TPB pair for the presence of the remotely supplied twisted-pair bias voltage.

The TSB43AB21A device provides a 1.86-V nominal bias voltage at the TPBIAS terminal for port termination. This bias voltage, when seen through a cable by a remote receiver, indicates the presence of an active connection. This bias voltage source must be stabilized by an external filter capacitor of 1.0 μ F.

The line drivers in the TSB43AB21A device operate in a high-impedance current mode and are designed to work with external 112- Ω line-termination resistor networks in order to match the 110- Ω cable impedance. The network is composed of a pair of series-connected 56- Ω resistors. The midpoint of the pair of resistors that is directly connected to the TPA terminals is connected to its corresponding TPBIAS voltage terminal. The midpoint of the pair of resistors that is directly connected to the TPB terminals is coupled to ground through a parallel R-C network with recommended values of 5 k Ω and 220 pF. The values of the external line-termination resistors are designed to meet the standard specifications when connected in parallel with the internal receiver circuits. An external resistor connected between the R0 and R1 terminals sets the driver output current and other internal operating currents. This current-setting resistor has a value of 6.34 k Ω \pm 1%.

When the power supply of the TSB43AB21A device is off and the twisted-pair cables are connected, the TSB43AB21A transmitter and receiver circuitry present a high impedance to the cable and do not load the TPBIAS voltage at the other end of the cable.

When the device is in a low-power state (for example, D2 or D3) the TSB43AB21A device automatically enters a low-power mode if the port is inactive (disconnected, disabled, or suspended). In this low-power mode, the TSB43AB21A device disables its internal clock generators and also disables various voltage and current reference circuits, depending on the state of the port (some reference circuitry must remain active in order to detect new cable connections, disconnections, or incoming TPBIAS, for example). The lowest power consumption (the ultralow-power sleep mode) is attained when the port is either disconnected or disabled with the port interrupt enable bit cleared.

The TSB43AB21A device exits the low-power mode when bit 19 (LPS) in the host controller control register at OHCI offset 50h/54h (see Section 4.16, *Host Controller Control Register*) is set to 1 or when a port event occurs which requires that the TSB43AB21A device to become active in order to respond to the event or to notify the LLC of the event (for example, incoming bias is detected on a suspended port, a disconnection is detected on a suspended port, or a new connection is detected on a nondisabled port). When the TSB43AB21A device is in the low-power mode, the internal 49.153-MHz clock becomes active (and the integrated PHY layer becomes operative) within 2 ms after bit 19 (LPS) in the host controller control register at OHCI offset 50h/54h (see Section 4.16, *Host Controller Control Register*) is set to 1.

The TSB43AB21A device supports hardware enhancements to better support digital video (DV) and MPEG data stream reception and transmission. These enhancements are enabled through the isochronous receive digital video enhancements register at OHCI offset A88h (see Chapter 5, *TI Extension Registers*). The enhancements include automatic timestamp insertion for transmitted DV and MPEG-formatted streams and common isochronous packet (CIP) header stripping for received DV streams.

The CIP format is defined by the IEC 61883-1:1998 specification. The enhancements to the isochronous data contexts are implemented as hardware support for the synchronization timestamp for both DV and MPEG CIP formats. The TSB43AB21A device supports modification of the synchronization timestamp field to ensure that the value inserted via software is not stale—that is, the value is less than the current cycle timer when the packet is transmitted.

1.2 Features

The TSB43AB21A device supports the following features:

- Fully compliant with *1394 Open Host Controller Interface Specification* (Release 1.1)
- Fully compliant with provisions of IEEE Std 1394-1995 for a high-performance serial bus[†] and IEEE Std 1394a-2000
- Fully interoperable with FireWire and i.LINK implementations of IEEE Std 1394
- Compliant with Intel *Mobile Power Guideline 2000*
- Full IEEE Std 1394a-2000 support includes: connection debounce, arbitrated short reset, multispeed concatenation, arbitration acceleration, fly-by concatenation, and port disable/suspend/resume
- Power-down features to conserve energy in battery-powered applications include: automatic device power down during suspend, PCI power management for link-layer, and inactive ports powered down
- Ultralow-power sleep mode
- One IEEE Std 1394a-2000 fully compliant cable port at 100M bits/s, 200M bits/s, or 400M bits/s
- Cable port monitors line conditions for active connection to remote node
- Cable power presence monitoring
- 1.8-V core logic with universal PCI interfaces compatible with 3.3-V and 5-V PCI signaling environments
- Physical write posting of up to three outstanding transactions
- PCI burst transfers and deep FIFOs to tolerate large host latency
- $\overline{\text{PCI_CLKRUN}}$ protocol
- External cycle timer control for customized synchronization
- Extended resume signaling for compatibility with legacy DV components
- PHY-link logic performs system initialization and arbitration functions
- PHY-link encode and decode functions included for data-strobe bit level encoding
- PHY-link incoming data resynchronized to local clock
- Low-cost 24.576-MHz crystal provides transmit and receive data at 100M bits/s, 200M bits/s, or 400M bits/s
- Node power class information signaling for system power management
- Serial ROM interface supports 2-wire serial EEPROM devices
- Two general-purpose I/Os
- Register bits give software control of contender bit, power class bits, link active control bit, and IEEE Std 1394a-2000 features
- Fabricated in advanced low-power CMOS process
- PCI and CardBus register support
- Isochronous receive dual-buffer mode
- Out-of-order pipelining for asynchronous transmit requests
- Register access fail interrupt when the PHY SCLK is not active
- PCI power-management D0, D1, D2, and D3 power states

[†] Implements technology covered by one or more patents of Apple Computer, Incorporated and SGS Thompson, Limited.

- Initial bandwidth available and initial channels available registers
- $\overline{\text{PME}}$ support per *1394 Open Host Controller Interface Specification*

1.3 Related Documents

- *1394 Open Host Controller Interface Specification* (Release 1.1)
- *IEEE Standard for a High Performance Serial Bus* (IEEE Std 1394-1995)
- *IEEE Standard for a High Performance Serial Bus—Amendment 1* (IEEE Std 1394a-2000)
- *PC Card Standard—Electrical Specification*
- *PC 2001 Design Guide*
- *PCI Bus Power Management Interface Specification* (Revision 1.1)
- *PCI Local Bus Specification* (Revision 2.2)
- *Mobile Power Guideline 2000*
- *Serial Bus Protocol 2* (SBP-2)
- *IEC 61883-1:1998 Consumer Audio/Video Equipment Digital Interface Part 1: General*

1.4 Trademarks

OHCI-Lynx and TI are trademarks of Texas Instruments.

Other trademarks are the property of their respective owners.

1.5 Ordering Information

ORDERING NUMBER	NAME	VOLTAGE	PACKAGE
TSB43AB21A	iOHCI-Lynx	3.3 V	PDT
TSB43AB21AI	iOHCI-Lynx (industrial temperature)	3.3 V	PDT

2 Terminal Descriptions

This section provides the terminal descriptions for the TSB43AB21A device. Figure 2–1 shows the signal assigned to each terminal in the package. Table 2–1 and Table 2–2 provide a cross-reference between each terminal number and the signal name on that terminal. Table 2–1 is arranged in terminal number order, and Table 2–2 lists signals in alphabetical order.

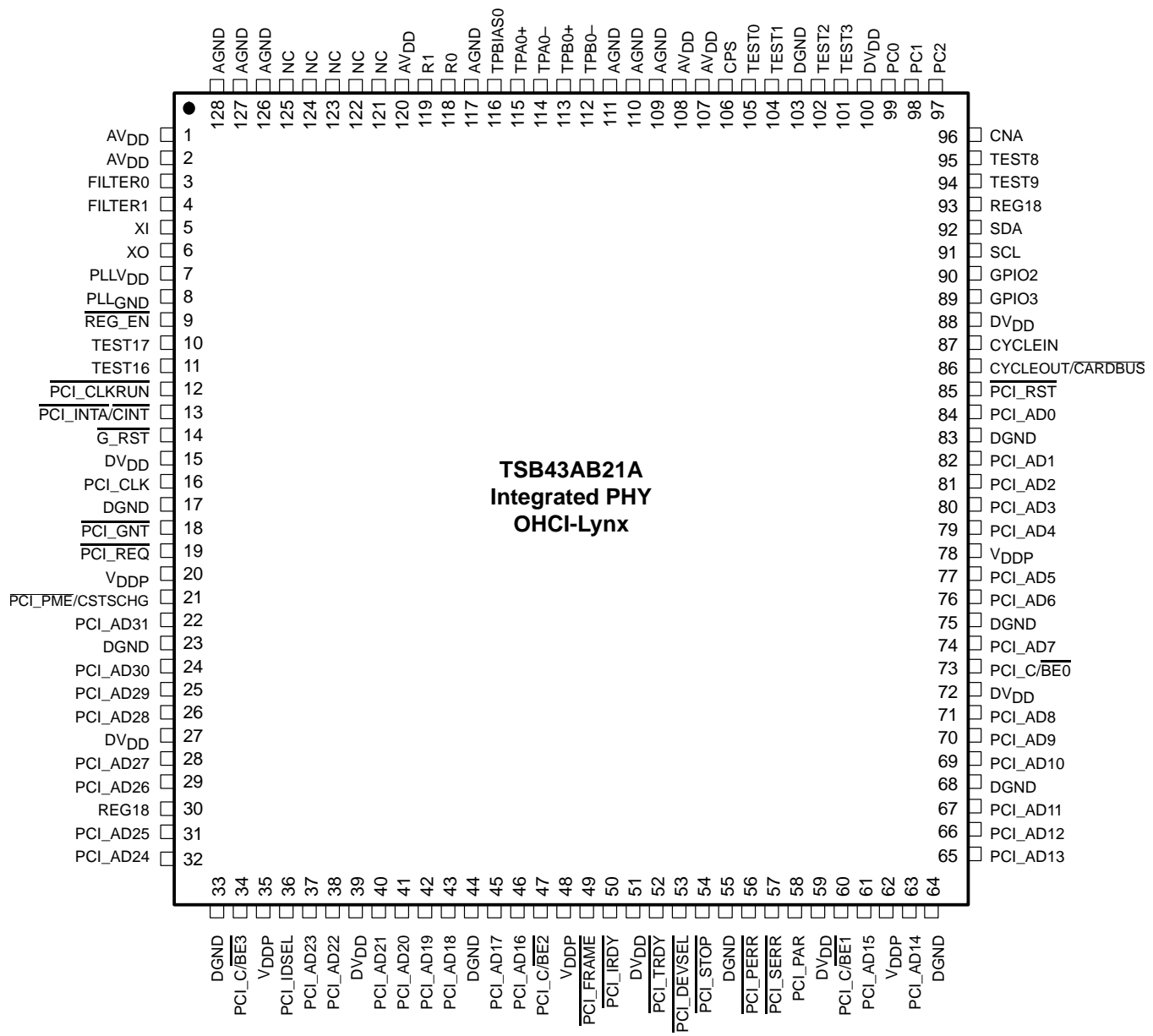

Figure 2–1. TSB43AB21A Terminal Assignments

Table 2–1. Signals Sorted by Terminal Number

NO.	TERMINAL NAME	NO.	TERMINAL NAME	NO.	TERMINAL NAME	NO.	TERMINAL NAME
1	AVDD	33	DGND	65	PCI_AD13	97	PC2
2	AVDD	34	PCI_C/BE3	66	PCI_AD12	98	PC1
3	FILTER0	35	VDDP	67	PCI_AD11	99	PC0
4	FILTER1	36	PCI_IDSEL	68	DGND	100	DVDD
5	XI	37	PCI_AD23	69	PCI_AD10	101	TEST3
6	XO	38	PCI_AD22	70	PCI_AD9	102	TEST2
7	PLLVD	39	DVDD	71	PCI_AD8	103	DGND
8	PLLGN	40	PCI_AD21	72	DVDD	104	TEST1
9	REG_EN	41	PCI_AD20	73	PCI_C/BE0	105	TEST0
10	TEST17	42	PCI_AD19	74	PCI_AD7	106	CPS
11	TEST16	43	PCI_AD18	75	DGND	107	AVDD
12	PCI_CLKRUN	44	DGND	76	PCI_AD6	108	AVDD
13	PCI_INTA/CINT	45	PCI_AD17	77	PCI_AD5	109	AGND
14	G_RST	46	PCI_AD16	78	VDDP	110	AGND
15	DVDD	47	PCI_C/BE2	79	PCI_AD4	111	AGND
16	PCI_CLK	48	VDDP	80	PCI_AD3	112	TPB0–
17	DGND	49	PCI_FRAME	81	PCI_AD2	113	TPB0+
18	PCI_GNT	50	PCI_IRDY	82	PCI_AD1	114	TPA0–
19	PCI_REQ	51	DVDD	83	DGND	115	TPA0+
20	VDDP	52	PCI_TRDY	84	PCI_AD0	116	TPBIAS0
21	PCI_PME/CSTSCHG	53	PCI_DEVSEL	85	PCI_RST	117	AGND
22	PCI_AD31	54	PCI_STOP	86	CYCLEOUT/CARDBUS	118	R0
23	DGND	55	DGND	87	CYCLEIN	119	R1
24	PCI_AD30	56	PCI_PERR	88	DVDD	120	AVDD
25	PCI_AD29	57	PCI_SERR	89	GPIO3	121	NC
26	PCI_AD28	58	PCI_PAR	90	GPIO2	122	NC
27	DVDD	59	DVDD	91	SCL	123	NC
28	PCI_AD27	60	PCI_C/BE1	92	SDA	124	NC
29	PCI_AD26	61	PCI_AD15	93	REG18	125	NC
30	REG18	62	VDDP	94	TEST9	126	AGND
31	PCI_AD25	63	PCI_AD14	95	TEST8	127	AGND
32	PCI_AD24	64	DGND	96	CNA	128	AGND

Table 2–2. Signal Names Sorted Alphanumerically to Terminal Number

TERMINAL NAME	NO.	TERMINAL NAME	NO.	TERMINAL NAME	NO.	TERMINAL NAME	NO.
AGND	109	DVDD	88	PCI_AD17	45	PCI_SERR	57
AGND	110	DVDD	100	PCI_AD18	43	PCI_STOP	54
AGND	111	FILTER0	3	PCI_AD19	42	PCI_TRDY	52
AGND	117	FILTER1	4	PCI_AD20	41	PLL_GND	8
AGND	126	GPIO2	90	PCI_AD21	40	PLL_VDD	7
AGND	127	GPIO3	89	PCI_AD22	38	REG_EN	9
AGND	128	G_RST	14	PCI_AD23	37	REG18	30
AVDD	1	NC	121	PCI_AD24	32	REG18	93
AVDD	2	NC	122	PCI_AD25	31	R0	118
AVDD	107	NC	123	PCI_AD26	29	R1	119
AVDD	108	NC	124	PCI_AD27	28	SCL	91
AVDD	120	NC	125	PCI_AD28	26	SDA	92
CNA	96	PC0	99	PCI_AD29	25	TEST0	105
CPS	106	PC1	98	PCI_AD30	24	TEST1	104
CYCLEIN	87	PC2	97	PCI_AD31	22	TEST2	102
CYCLEOUT/CARDBUS	86	PCI_AD0	84	PCI_C/BE0	73	TEST3	101
DGND	17	PCI_AD1	82	PCI_C/BE1	60	TEST8	95
DGND	23	PCI_AD2	81	PCI_C/BE2	47	TEST9	94
DGND	33	PCI_AD3	80	PCI_C/BE3	34	TEST16	11
DGND	44	PCI_AD4	79	PCI_CLK	16	TEST17	10
DGND	55	PCI_AD5	77	PCI_CLKRUN	12	TPA0–	114
DGND	64	PCI_AD6	76	PCI_DEVSEL	53	TPA0+	115
DGND	68	PCI_AD7	74	PCI_FRAME	49	TPB0–	112
DGND	75	PCI_AD8	71	PCI_GNT	18	TPB0+	113
DGND	83	PCI_AD9	70	PCI_IDSEL	36	TPBIAS0	116
DGND	103	PCI_AD10	69	PCI_INTA/CINT	13	VDDP	20
DVDD	15	PCI_AD11	67	PCI_IRDY	50	VDDP	35
DVDD	27	PCI_AD12	66	PCI_PAR	58	VDDP	48
DVDD	39	PCI_AD13	65	PCI_PERR	56	VDDP	62
DVDD	51	PCI_AD14	63	PCI_PME/CSTSCHG	21	VDDP	78
DVDD	59	PCI_AD15	61	PCI_REQ	19	XI	5
DVDD	72	PCI_AD16	46	PCI_RST	85	XO	6

The terminals are grouped in tables by functionality, such as PCI system function and power supply function (see Table 2–3 through Table 2–8). The terminal numbers are also listed for convenient reference.

Table 2–3. PCI System Terminals

TERMINAL NAME	NO.	I/O	DESCRIPTION
$\overline{\text{G_RST}}$	14	I	Global power reset. This reset brings all of the TSB43AB21A internal registers to their default states, including those registers not reset by $\overline{\text{PCI_RST}}$. When $\overline{\text{G_RST}}$ is asserted, the device is completely nonfunctional, placing all output buffers in a high-impedance state. When implementing wake capabilities from the 1394 host controller, it is necessary to implement two resets to the TSB43AB21A device. $\overline{\text{G_RST}}$ is designed to be a one-time power-on reset, and $\overline{\text{PCI_RST}}$ must be connected to the PCI bus $\overline{\text{RST}}$. $\overline{\text{G_RST}}$ must be asserted for a minimum of 2 ms.
PCI_CLK	16	I	PCI bus clock. Provides timing for all transactions on the PCI bus. All PCI signals are sampled at the rising edge of PCI_CLK.
$\overline{\text{PCI_INTA/CINT}}$	13	O	Interrupt signal. This output indicates interrupts from the TSB43AB21A device to the host. This terminal signals a CardBus interrupt (CINT) when CARDBUS (terminal 86) is tied low.
$\overline{\text{PCI_RST}}$	85	I	PCI reset. When this bus reset is asserted, the TSB43AB21A device places all output buffers in a high-impedance state and resets all internal registers except device power management context- and vendor-specific bits initialized by host power-on software. When $\overline{\text{PCI_RST}}$ is asserted, the device is completely nonfunctional. Connect this terminal to PCI bus $\overline{\text{RST}}$.

Table 2–4. PCI Address and Data Terminals

TERMINAL NAME	NO.	I/O	DESCRIPTION
PCI_AD31	22	I/O	PCI address/data bus. These signals make up the multiplexed PCI address and data bus on the PCI interface. During the address phase of a PCI cycle, AD31–AD0 contain a 32-bit address or other destination information. During the data phase, AD31–AD0 contain data.
PCI_AD30	24		
PCI_AD29	25		
PCI_AD28	26		
PCI_AD27	28		
PCI_AD26	29		
PCI_AD25	31		
PCI_AD24	32		
PCI_AD23	37		
PCI_AD22	38		
PCI_AD21	40		
PCI_AD20	41		
PCI_AD19	42		
PCI_AD18	43		
PCI_AD17	45		
PCI_AD16	46		
PCI_AD15	61		
PCI_AD14	63		
PCI_AD13	65		
PCI_AD12	66		
PCI_AD11	67		
PCI_AD10	69		
PCI_AD9	70		
PCI_AD8	71		
PCI_AD7	74		
PCI_AD6	76		
PCI_AD5	77		
PCI_AD4	79		
PCI_AD3	80		
PCI_AD2	81		
PCI_AD1	82		
PCI_AD0	84		

Table 2–5. PCI Interface Control Terminals

TERMINAL NAME	NO.	I/O	DESCRIPTION
$\overline{\text{PCI_CLKRUN}}$	12	I/O	Clock run. This terminal provides clock control through the $\overline{\text{CLKRUN}}$ protocol. This terminal is implemented as open-drain and must be pulled low through a 10-k Ω nominal resistor for designs where $\overline{\text{CLKRUN}}$ is not implemented. For mobile applications where $\overline{\text{CLKRUN}}$ is implemented, the pullup resistor is typically provided by the system central resource.
$\overline{\text{PCI_C/BE0}}$ $\overline{\text{PCI_C/BE1}}$ $\overline{\text{PCI_C/BE2}}$ $\overline{\text{PCI_C/BE3}}$	73 60 47 34	I/O	PCI bus commands and byte enables. The command and byte enable signals are multiplexed on the same PCI terminals. During the address phase of a bus cycle, $\overline{\text{PCI_C/BE3}}$ – $\overline{\text{PCI_C/BE0}}$ define the bus command. During the data phase, this 4-bit bus is used for byte enables.
$\overline{\text{PCI_DEVSEL}}$	53	I/O	PCI device select. The TSB43AB21A device asserts this signal to claim a PCI cycle as the target device. As a PCI initiator, the TSB43AB21A device monitors this signal until a target responds. If no target responds before time-out occurs, the TSB43AB21A device terminates the cycle with an initiator abort.
$\overline{\text{PCI_FRAME}}$	49	I/O	PCI cycle frame. This signal is driven by the initiator of a PCI bus cycle. $\overline{\text{PCI_FRAME}}$ is asserted to indicate that a bus transaction is beginning, and data transfers continue while this signal is asserted. When $\overline{\text{PCI_FRAME}}$ is deasserted, the PCI bus transaction is in the final data phase.
$\overline{\text{PCI_GNT}}$	18	I	PCI bus grant. This signal is driven by the PCI bus arbiter to grant the TSB43AB21A device access to the PCI bus after the current data transaction has completed. This signal may or may not follow a PCI bus request, depending upon the PCI bus parking algorithm.
$\overline{\text{PCI_IDSEL}}$	36	I	Initialization device select. $\overline{\text{PCI_IDSEL}}$ selects the TSB43AB21A device during configuration space accesses. $\overline{\text{PCI_IDSEL}}$ can be connected to 1 of the upper 21 PCI address lines on the PCI bus.
$\overline{\text{PCI_IRDY}}$	50	I/O	PCI initiator ready. $\overline{\text{PCI_IRDY}}$ indicates the ability of the PCI bus initiator to complete the current data phase of the transaction. A data phase is completed upon a rising edge of $\overline{\text{PCI_CLK}}$ where both $\overline{\text{PCI_IRDY}}$ and $\overline{\text{PCI_TRDY}}$ are asserted.
$\overline{\text{PCI_PAR}}$	58	I/O	PCI parity. In all PCI bus read and write cycles, the TSB43AB21A device calculates even parity across the $\overline{\text{PCI_AD}}$ and $\overline{\text{PCI_C/BE}}$ buses. As an initiator during PCI cycles, the TSB43AB21A device outputs this parity indicator with a one- $\overline{\text{PCI_CLK}}$ delay. As a target during PCI cycles, the calculated parity is compared to the initiator parity indicator; a miscompare can result in a parity error assertion ($\overline{\text{PCI_PERR}}$).
$\overline{\text{PCI_PERR}}$	56	I/O	PCI parity error indicator. This signal is driven by a PCI device to indicate that calculated parity does not match $\overline{\text{PCI_PAR}}$ when bit 6 ($\overline{\text{PERR_ENB}}$) is set to 1 in the command register at offset 04h in the PCI configuration space (see Section 3.4, <i>Command Register</i>).
$\overline{\text{PCI_PME/}}$ $\overline{\text{CSTSCHG}}$	21	O	Power management event or card status change. This terminal indicates wake events to the host. When implemented in a CardBus application and $\overline{\text{CARDBUS}}$ is tied low, the output is the active high $\overline{\text{CSTSCHG}}$ indication. This terminal is implemented as an open-drain output.
$\overline{\text{PCI_REQ}}$	19	O	PCI bus request. Asserted by the TSB43AB21A device to request access to the bus as an initiator. The host arbiter asserts $\overline{\text{PCI_GNT}}$ when the TSB43AB21A device has been granted access to the bus.
$\overline{\text{PCI_SERR}}$	57	O	PCI system error. When bit 8 ($\overline{\text{SERR_ENB}}$) in the command register at offset 04h in the PCI configuration space (see Section 3.4, <i>Command Register</i>) is set to 1, the output is pulsed, indicating an address parity error has occurred. The TSB43AB21A device need not be the target of the PCI cycle to assert this signal. This terminal is implemented as open-drain.
$\overline{\text{PCI_STOP}}$	54	I/O	PCI cycle stop signal. This signal is driven by a PCI target to request the initiator to stop the current PCI bus transaction. This signal is used for target disconnects, and is commonly asserted by target devices which do not support burst data transfers.
$\overline{\text{PCI_TRDY}}$	52	I/O	PCI target ready. $\overline{\text{PCI_TRDY}}$ indicates the ability of the PCI bus target to complete the current data phase of the transaction. A data phase is completed upon a rising edge of $\overline{\text{PCI_CLK}}$ where both $\overline{\text{PCI_IRDY}}$ and $\overline{\text{PCI_TRDY}}$ are asserted.

Table 2–6. Miscellaneous Terminals

TERMINAL NAME	NO.	I/O	DESCRIPTION
CYCLEIN	87	I/O	The CYCLEIN terminal allows an external 8-kHz clock to be used as a cycle timer for synchronization with other system devices. If this terminal is not implemented, it must be pulled high to DV _{DD} through a pullup resistor.
CYCLEOUT/ CARDBUS	86	I/O	This terminal is sampled when <u>G_RST</u> is asserted and is used to select between PC Card and non-PC Card implementations. If CARDBUS is sampled low at reset, software programs an appropriate value into the CardBus CIS base address register at offset 18h in the PCI configuration space (see Section 3.11, <i>CardBus CIS Base Address Register</i>). After reset, this terminal may function as CYCLEOUT. The CYCLEOUT terminal provides an 8-kHz cycle timer synchronization signal. If CYCLEOUT is not implemented, this terminal must be pulled up to DV _{DD} through a pullup resistor. For CardBus implementations, this terminal must be tied to ground through a pulldown resistor and the pullup resistor is not needed.
GPIO2	90	I/O	General-purpose I/O [2]. This terminal defaults as an input and if it is not implemented, it is recommended that it be pulled low to ground with a 220-Ω resistor.
GPIO3	89	I/O	General-purpose I/O [3]. This terminal defaults as an input and if it is not implemented, it is recommended that it be pulled low to ground with a 220-Ω resistor.
REG_EN	9	I	Regulator enable. This terminal must be tied to ground to enable the internal voltage regulator. When using a single 3.3-V supply, this terminal must be tied to ground to enable the internal voltage regulator. When using a dual 1.8-V/3.3-V supply to provide power to the device, <u>REG_EN</u> must be pulled to DV _{DD} to disable the internal voltage regulator.
SCL	91	I/O	Serial clock. This terminal provides the serial clock signaling and is implemented as open-drain. For normal operation (a ROM is implemented in the design), this terminal must be pulled high to the ROM DV _{DD} with a 2.7-kΩ resistor. Otherwise, it must be pulled low to ground with a 220-Ω resistor.
SDA	92	I/O	Serial data. At <u>PCI_RST</u> , the SDA signal is sampled to determine if a two-wire serial ROM is present. If the serial ROM is detected, this terminal provides the serial data signaling. This terminal is implemented as open-drain, and for normal operation (a ROM is implemented in the design), this terminal must be pulled high to the ROM DV _{DD} with a 2.7-kΩ resistor. Otherwise, it must be pulled low to ground with a 220-Ω resistor.
TEST17 TEST16 TEST9 TEST8 TEST3 TEST2 TEST1 TEST0	10 11 94 95 101 102 104 105	I/O	Terminals TEST[9, 8, 3, 2, 1, 0] are used for factory test of the TSB43AB21A device and must be connected to ground for normal operation. Terminal TEST[17:16] must be pulled to V _{DD} . These terminals can be pulled to V _{DD} through a common pullup resistor.

Table 2–7. Physical Layer Terminals

TERMINAL NAME	NO.	TYPE	I/O	DESCRIPTION
CNA	96	CMOS	I/O	Cable not active. This terminal is asserted high when the port is not receiving incoming bias voltage. If not used, this terminal must be strapped either to DV _{DD} or to GND through a resistor. To enable the CNA terminal, the BIOS must set bit 7 (CNAOUT) of the PCI PHY control register at offset ECh in the PCI configuration space (see Section 3.22, <i>PCI PHY Control Register</i>). If an EEPROM is implemented and CNA functionality is needed, bit 7 of byte offset 16h in the serial EEPROM must be set. This sets the bit in the PCI configuration space at power up via the EEPROM.
CPS	106	CMOS	I	Cable power status input. This terminal is normally connected to cable power through a 400-k Ω resistor. This circuit drives an internal comparator that detects the presence of cable power. If CPS does not detect cable power, this terminal must be pulled to AV _{DD} .
FILTER0 FILTER1	3 4	CMOS	I/O	PLL filter terminals. These terminals are connected to an external capacitance to form a lag-lead filter required for stable operation of the internal frequency multiplier PLL running off of the crystal oscillator. A 0.1- μ F \pm 10% capacitor is the only external component required to complete this filter.
PC0 PC1 PC2	99 98 97	CMOS	I	Power class programming inputs. On hardware reset, these inputs set the default value of the power class indicated during self-ID. Programming is done by tying these terminals high or low.
R0 R1	118 119	Bias	–	Current-setting resistor terminals. These terminals are connected to an external resistance to set the internal operating currents and cable driver output currents. A resistance of 6.34 k Ω \pm 1% is required to meet the IEEE Std 1394-1995 output voltage limits.
TPA0+ TPA0–	115 114	Cable	I/O	Twisted-pair cable A differential signal terminals. Board trace lengths from each pair of positive and negative differential signal pins must be matched and as short as possible to the external load resistors and to the cable connector.
TPB0+ TPB0–	113 112	Cable	I/O	Twisted-pair cable B differential signal terminals. Board trace lengths from each pair of positive and negative differential signal pins must be matched and as short as possible to the external load resistors and to the cable connector.
TPBIAS0	116	Cable	I/O	Twisted-pair bias output. This provides the 1.86-V nominal bias voltage needed for proper operation of the twisted-pair cable drivers and receivers and for signaling to the remote nodes that there is an active cable connection. Each of these pins must be decoupled with a 1.0- μ F capacitor to ground.
XI XO	5 6	Crystal	–	Crystal oscillator inputs. These pins connect to a 24.576-MHz parallel resonant fundamental mode crystal. The optimum values for the external shunt capacitors are dependent on the specifications of the crystal used (see Section 8.2, <i>Crystal Selection</i>). Terminal 5 has an internal 10-k Ω (nominal value) pulldown resistor. An external clock input can be connected to the XI terminal. When using an external clock input, the XO terminal must be left unconnected. Refer to Section 9.7 for the operating characteristics of the XI terminal.

Table 2–8. Power Supply Terminals

TERMINAL NAME	TERMINAL NO.	TYPE	I/O	DESCRIPTION
AGND	109–111, 117, 126–128	Supply	–	Analog circuit ground terminals. These terminals must be tied together to the low-impedance circuit board ground plane.
AV _{DD}	1, 2, 107, 108, 120	Supply	–	Analog circuit power terminals. A parallel combination of high frequency decoupling capacitors near each terminal is suggested, such as 0.1 μ F and 0.001 μ F. Lower frequency 10- μ F filtering capacitors are also recommended. These supply terminals are separated from PLLV _{DD} and DV _{DD} internal to the device to provide noise isolation. They must be tied at a low-impedance point on the circuit board.
DGND	17, 23, 33, 44, 55, 64, 68, 75, 83, 103	Supply	–	Digital circuit ground terminals. These terminals must be tied together to the low-impedance circuit board ground plane.
DV _{DD}	15, 27, 39, 51, 59, 72, 88, 100	Supply	–	Digital circuit power terminals. A parallel combination of high frequency decoupling capacitors near each DV _{DD} terminal is suggested, such as 0.1 μ F and 0.001 μ F. Lower frequency 10- μ F filtering capacitors are also recommended. These supply terminals are separated from PLLV _{DD} and AV _{DD} internal to the device to provide noise isolation. They must be tied at a low-impedance point on the circuit board.
PLL _{GND}	8	Supply	–	PLL circuit ground terminal. This terminal must be tied to the low-impedance circuit board ground plane.
PLL _{VDD}	7	Supply	–	PLL circuit power terminal. A parallel combination of high frequency decoupling capacitors near the terminal is suggested, such as 0.1 μ F and 0.001 μ F. Lower frequency 10- μ F filtering capacitors are also recommended. This supply terminal is separated from DV _{DD} and AV _{DD} internal to the device to provide noise isolation. It must be tied to a low-impedance point on the circuit board.
REG18	30, 93	Supply	–	REG18. 1.8-V power supply for the device core. If the internal voltage regulator is enabled (REG_EN is tied low), these terminals must be left unconnected. The internal voltage regulator provides 1.8 V from DV _{DD} . When the internal regulator is disabled (REG_EN is high), the REG18 terminals can be used to supply an external 1.8-V supply to the TSB43AB21A core. It is recommended that 0.1- μ F bypass capacitors be used and placed close to these terminals.
V _{DDP}	20, 35, 48, 62, 78	Supply	–	PCI signaling clamp voltage power input. PCI signals are clamped per the <i>PCI Local Bus Specification</i> . In addition, if a 5-V ROM is used, the V _{DDP} must be connected to 5 V.

3 TSB43AB21A 1394 OHCI Controller Programming Model

This section describes the internal PCI configuration registers used to program the TSB43AB21A 1394 open host controller interface. All registers are detailed in the same format: a brief description for each register is followed by the register offset and a bit table describing the reset state for each register.

A bit description table, typically included when the register contains bits of more than one type or purpose, indicates bit field names, a detailed field description, and field access tags which appear in the *type* column. Table 3–1 describes the field access tags.

Table 3–1. Bit Field Access Tag Descriptions

ACCESS TAG	NAME	MEANING
R	Read	Field can be read by software.
W	Write	Field can be written by software to any value.
S	Set	Field can be set by a write of 1. Writes of 0 have no effect.
C	Clear	Field can be cleared by a write of 1. Writes of 0 have no effect.
U	Update	Field can be autonomously updated by the TSB43AB21A device.

Figure 3–1 shows a simplified block diagram of the TSB43AB21A device.

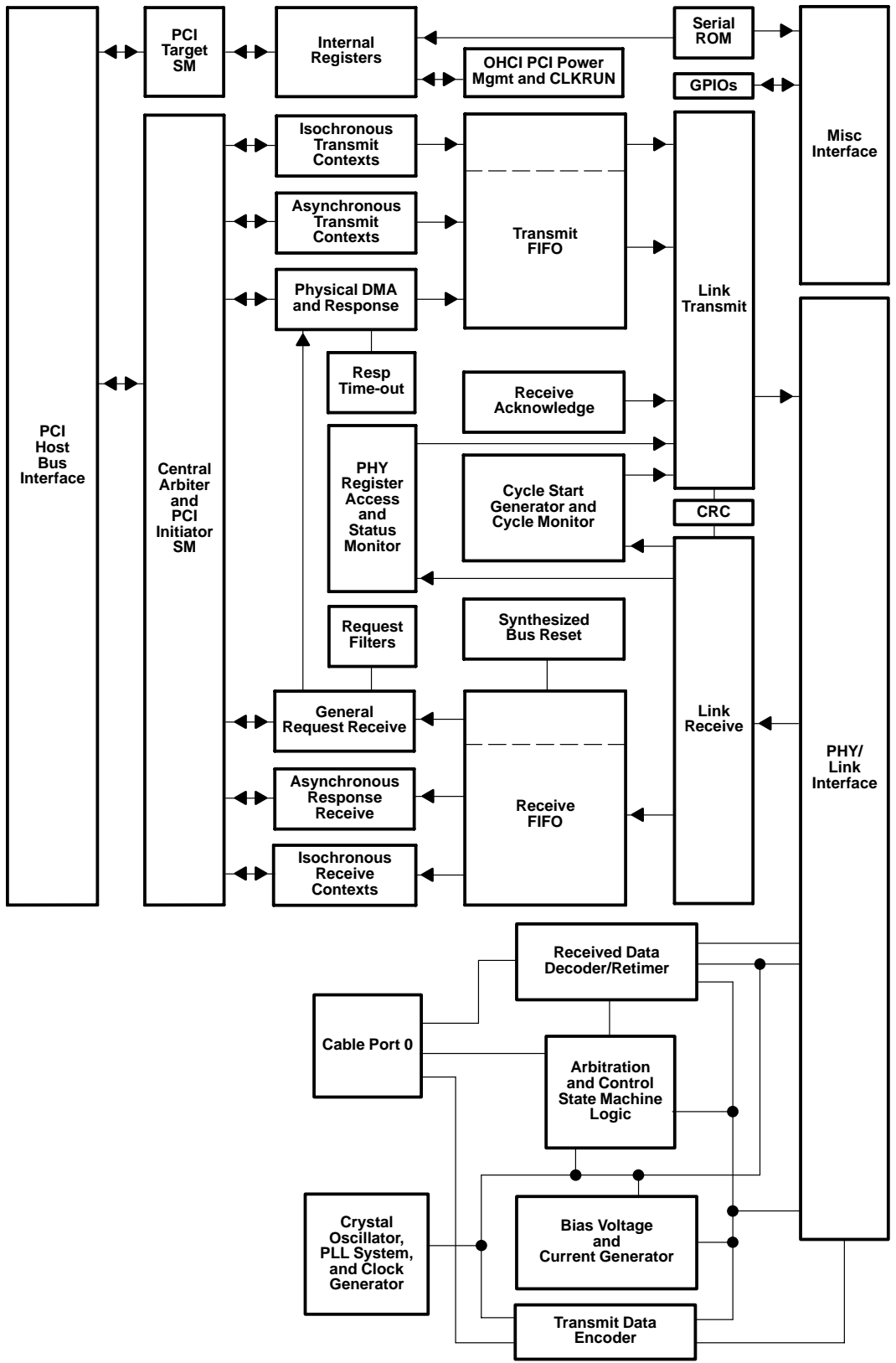

Figure 3–1. TSB43AB21A Block Diagram

3.1 PCI Configuration Registers

The TSB43AB21A device is a single-function PCI device. The configuration header is compliant with the *PCI Local Bus Specification* as a standard header. Table 3–2 illustrates the PCI configuration header that includes both the predefined portion of the configuration space and the user-definable registers.

Table 3–2. PCI Configuration Register Map

REGISTER NAME				OFFSET
Device ID		Vendor ID		00h
Status		Command		04h
Class code			Revision ID	08h
BIST	Header type	Latency timer	Cache line size	0Ch
OHCI base address				10h
TI extension base address				14h
CardBus CIS base address				18h
Reserved				1Ch–27h
CardBus CIS pointer				28h
Subsystem ID		Subsystem vendor ID		2Ch
Reserved				30h
Reserved			PCI power management capabilities pointer	34h
Reserved				38h
Maximum latency	Minimum grant	Interrupt pin	Interrupt line	3Ch
OHCI control				40h
Power management capabilities		Next item pointer	Capability ID	44h
PM data	PMCSR_BSE	Power management control and status		48h
Reserved				4Ch–EBh
PCI PHY control				ECh
Miscellaneous configuration				F0h
Link enhancement control				F4h
Subsystem device ID alias		Subsystem vendor ID alias		F8h
GPIO3	GPIO2	Reserved		FCh

3.2 Vendor ID Register

The vendor ID register contains a value allocated by the PCI SIG and identifies the manufacturer of the PCI device. The vendor ID assigned to Texas Instruments is 104Ch.

Bit	15	14	13	12	11	10	9	8	7	6	5	4	3	2	1	0
Name	Vendor ID															
Type	R	R	R	R	R	R	R	R	R	R	R	R	R	R	R	R
Default	0	0	0	1	0	0	0	0	0	1	0	0	1	1	0	0

Register: **Vendor ID**
 Offset: 00h
 Type: Read-Only
 Default: 104Ch

3.3 Device ID Register

The device ID register contains a value assigned to the TSB43AB21A device by Texas Instruments. The device identification for the TSB43AB21A device is 8026h.

Bit	15	14	13	12	11	10	9	8	7	6	5	4	3	2	1	0
Name	Device ID															
Type	R	R	R	R	R	R	R	R	R	R	R	R	R	R	R	R
Default	1	0	0	0	0	0	0	0	0	0	1	0	0	1	1	0

Register: **Device ID**
 Offset: 02h
 Type: Read-Only
 Default: 8026h

3.4 Command Register

The command register provides control over the TSB43AB21A interface to the PCI bus. All bit functions adhere to the definitions in the *PCI Local Bus Specification*, as seen in the following bit descriptions. See Table 3–3 for a complete description of the register contents.

Bit	15	14	13	12	11	10	9	8	7	6	5	4	3	2	1	0
Name	Command															
Type	R	R	R	R	R	R	R	R/W	R	R/W	R	R/W	R	R/W	R/W	R
Default	0	0	0	0	0	0	0	0	0	0	0	0	0	0	0	0

Register: **Command**
 Offset: 04h
 Type: Read/Write, Read-Only
 Default: 0000h

Table 3–3. Command Register Description

BIT	FIELD NAME	TYPE	DESCRIPTION
15–10	RSVD	R	Reserved. Bits 15–10 return 0s when read.
9	FBB_ENB	R	Fast back-to-back enable. The TSB43AB21A device does not generate fast back-to-back transactions; therefore, bit 9 returns 0 when read.
8	SERR_ENB	R/W	$\overline{\text{PCI_SERR}}$ enable. When bit 8 is set to 1, the TSB43AB21A $\overline{\text{PCI_SERR}}$ driver is enabled. $\overline{\text{PCI_SERR}}$ can be asserted after detecting an address parity error on the PCI bus.
7	STEP_ENB	R	Address/data stepping control. The TSB43AB21A device does not support address/data stepping; therefore, bit 7 is hardwired to 0.
6	PERR_ENB	R/W	Parity error enable. When bit 6 is set to 1, the TSB43AB21A device is enabled to drive $\overline{\text{PCI_PERR}}$ response to parity errors through the $\overline{\text{PCI_PERR}}$ signal.
5	VGA_ENB	R	VGA palette snoop enable. The TSB43AB21A device does not feature VGA palette snooping; therefore, bit 5 returns 0 when read.
4	MWI_ENB	R/W	Memory write and invalidate enable. When bit 4 is set to 1, the TSB43AB21A device is enabled to generate MWI PCI bus commands. If this bit is cleared, the TSB43AB21A device generates memory write commands instead.
3	SPECIAL	R	Special cycle enable. The TSB43AB21A function does not respond to special cycle transactions; therefore, bit 3 returns 0 when read.
2	MASTER_ENB	R/W	Bus master enable. When bit 2 is set to 1, the TSB43AB21A device is enabled to initiate cycles on the PCI bus.
1	MEMORY_ENB	R/W	Memory response enable. Setting bit 1 to 1 enables the TSB43AB21A device to respond to memory cycles on the PCI bus. This bit must be set to access OHCI registers.
0	IO_ENB	R	I/O space enable. The TSB43AB21A device does not implement any I/O-mapped functionality; therefore, bit 0 returns 0 when read.

3.5 Status Register

The status register provides status over the TSB43AB21A interface to the PCI bus. All bit functions adhere to the definitions in the *PCI Local Bus Specification*, as seen in the following bit descriptions. See Table 3–4 for a complete description of the register contents.

Bit	15	14	13	12	11	10	9	8	7	6	5	4	3	2	1	0
Name	Status															
Type	RCU	RCU	RCU	RCU	RCU	R	R	RCU	R	R	R	R	R	R	R	R
Default	0	0	0	0	0	0	1	0	0	0	0	1	0	0	0	0

Register: **Status**
 Offset: 06h
 Type: Read/Clear/Update, Read-Only
 Default: 0210h

Table 3–4. Status Register Description

BIT	FIELD NAME	TYPE	DESCRIPTION
15	PAR_ERR	RCU	Detected parity error. Bit 15 is set to 1 when either an address parity or data parity error is detected.
14	SYS_ERR	RCU	Signaled system error. Bit 14 is set to 1 when $\overline{\text{PCI_SERR}}$ is enabled and the TSB43AB21A device has signaled a system error to the host.
13	MABORT	RCU	Received master abort. Bit 13 is set to 1 when a cycle initiated by the TSB43AB21A device on the PCI bus has been terminated by a master abort.
12	TABORT_REC	RCU	Received target abort. Bit 12 is set to 1 when a cycle initiated by the TSB43AB21A device on the PCI bus was terminated by a target abort.
11	TABORT_SIG	RCU	Signaled target abort. Bit 11 is set to 1 by the TSB43AB21A device when it terminates a transaction on the PCI bus with a target abort.
10–9	PCI_SPEED	R	DEVSEL timing. Bits 10 and 9 encode the timing of $\overline{\text{PCI_DEVSEL}}$ and are hardwired to 01b, indicating that the TSB43AB21A device asserts this signal at a medium speed on nonconfiguration cycle accesses.
8	DATAPAR	RCU	Data parity error detected. Bit 8 is set to 1 when the following conditions have been met: a. $\overline{\text{PCI_PERR}}$ was asserted by any PCI device including the TSB43AB21A device. b. The TSB43AB21A device was the bus master during the data parity error. c. Bit 6 (PERR_EN) in the command register at offset 04h in the PCI configuration space (see Section 3.4, <i>Command Register</i>) is set to 1.
7	FBB_CAP	R	Fast back-to-back capable. The TSB43AB21A device cannot accept fast back-to-back transactions; therefore, bit 7 is hardwired to 0.
6	UDF	R	User-definable features (UDF) supported. The TSB43AB21A device does not support the UDF; therefore, bit 6 is hardwired to 0.
5	66MHZ	R	66-MHz capable. The TSB43AB21A device operates at a maximum PCI_CLK frequency of 33 MHz; therefore, bit 5 is hardwired to 0.
4	CAPLIST	R	Capabilities list. Bit 4 returns 1 when read, indicating that capabilities additional to standard PCI are implemented. The linked list of PCI power-management capabilities is implemented in this function.
3–0	RSVD	R	Reserved. Bits 3–0 return 0s when read.

3.6 Class Code and Revision ID Register

The class code and revision ID register categorizes the TSB43AB21A device as a serial bus controller (0Ch), controlling an IEEE 1394 bus (00h), with an OHCI programming model (10h). Furthermore, the TI chip revision is indicated in the least significant byte. See Table 3–5 for a complete description of the register contents.

Bit	31	30	29	28	27	26	25	24	23	22	21	20	19	18	17	16
Name	Class code and revision ID															
Type	R	R	R	R	R	R	R	R	R	R	R	R	R	R	R	R
Default	0	0	0	0	1	1	0	0	0	0	0	0	0	0	0	0
Bit	15	14	13	12	11	10	9	8	7	6	5	4	3	2	1	0
Name	Class code and revision ID															
Type	R	R	R	R	R	R	R	R	R	R	R	R	R	R	R	R
Default	0	0	0	1	0	0	0	0	0	0	0	0	0	0	0	0

Register: **Class code and revision ID**
 Offset: 08h
 Type: Read-Only
 Default: 0C00 1000h

Table 3–5. Class Code and Revision ID Register Description

BIT	FIELD NAME	TYPE	DESCRIPTION
31–24	BASECLASS	R	Base class. This field returns 0Ch when read, which broadly classifies the function as a serial bus controller.
23–16	SUBCLASS	R	Subclass. This field returns 00h when read, which specifically classifies the function as controlling an IEEE 1394 serial bus.
15–8	PGMIF	R	Programming interface. This field returns 10h when read, which indicates that the programming model is compliant with the <i>1394 Open Host Controller Interface Specification</i> .
7–0	CHIPREV	R	Silicon revision. This field returns 00h when read, which indicates the silicon revision of the TSB43AB21A device.

3.7 Latency Timer and Class Cache Line Size Register

The latency timer and class cache line size register is programmed by host BIOS to indicate system cache line size and the latency timer associated with the TSB43AB21A device. See Table 3–6 for a complete description of the register contents.

Bit	15	14	13	12	11	10	9	8	7	6	5	4	3	2	1	0
Name	Latency timer and class cache line size															
Type	R/W	R/W	R/W	R/W	R/W	R/W	R/W	R/W	R/W	R/W	R/W	R/W	R/W	R/W	R/W	R/W
Default	0	0	0	0	0	0	0	0	0	0	0	0	0	0	0	0

Register: **Latency timer and class cache line size**
 Offset: 0Ch
 Type: Read/Write
 Default: 0000h

Table 3–6. Latency Timer and Class Cache Line Size Register Description

BIT	FIELD NAME	TYPE	DESCRIPTION
15–8	LATENCY_TIMER	R/W	PCI latency timer. The value in this register specifies the latency timer for the TSB43AB21A device, in units of PCI clock cycles. When the TSB43AB21A device is a PCI bus initiator and asserts <code>PCI_FRAME</code> , the latency timer begins counting from zero. If the latency timer expires before the TSB43AB21A transaction has terminated, the TSB43AB21A device terminates the transaction when its <code>PCI_GNT</code> is deasserted.
7–0	CACHELINE_SZ	R/W	Cache line size. This value is used by the TSB43AB21A device during memory write and invalidate, memory-read line, and memory-read multiple transactions.

3.8 Header Type and BIST Register

The header type and built-in self-test (BIST) register indicates the TSB43AB21A PCI header type and no built-in self-test. See Table 3–7 for a complete description of the register contents.

Bit	15	14	13	12	11	10	9	8	7	6	5	4	3	2	1	0
Name	Header type and BIST															
Type	R	R	R	R	R	R	R	R	R	R	R	R	R	R	R	R
Default	0	0	0	0	0	0	0	0	0	0	0	0	0	0	0	0

Register: **Header type and BIST**
 Offset: 0Eh
 Type: Read-Only
 Default: 0000h

Table 3–7. Header Type and BIST Register Description

BIT	FIELD NAME	TYPE	DESCRIPTION
15–8	BIST	R	Built-in self-test. The TSB43AB21A device does not include a BIST; therefore, this field returns 00h when read.
7–0	HEADER_TYPE	R	PCI header type. The TSB43AB21A device includes the standard PCI header, which is communicated by returning 00h when this field is read.

3.9 OHCI Base Address Register

The OHCI base address register is programmed with a base address referencing the memory-mapped OHCI control. When BIOS writes all 1s to this register, the value read back is FFFF F800h, indicating that at least 2K bytes of memory address space are required for the OHCI registers. See Table 3–8 for a complete description of the register contents.

Bit	31	30	29	28	27	26	25	24	23	22	21	20	19	18	17	16
Name	OHCI base address															
Type	R/W	R/W	R/W	R/W	R/W	R/W	R/W	R/W	R/W	R/W	R/W	R/W	R/W	R/W	R/W	R/W
Default	0	0	0	0	0	0	0	0	0	0	0	0	0	0	0	0
Bit	15	14	13	12	11	10	9	8	7	6	5	4	3	2	1	0
Name	OHCI base address															
Type	R/W	R/W	R/W	R/W	R/W	R	R	R	R	R	R	R	R	R	R	R
Default	0	0	0	0	0	0	0	0	0	0	0	0	0	0	0	0

Register: **OHCI base address**
 Offset: 10h
 Type: Read/Write, Read-Only
 Default: 0000 0000h

Table 3–8. OHCI Base Address Register Description

BIT	FIELD NAME	TYPE	DESCRIPTION
31–11	OHCIREG_PTR	R/W	OHCI register pointer. This field specifies the upper 21 bits of the 32-bit OHCI base address register.
10–4	OHCI_SZ	R	OHCI register size. This field returns 0s when read, indicating that the OHCI registers require a 2K-byte region of memory.
3	OHCI_PF	R	OHCI register prefetch. Bit 3 returns 0 when read, indicating that the OHCI registers are nonprefetchable.
2–1	OHCI_MEMTYPE	R	OHCI memory type. This field returns 0s when read, indicating that the OHCI base address register is 32 bits wide and mapping can be done anywhere in the 32-bit memory space.
0	OHCI_MEM	R	OHCI memory indicator. Bit 0 returns 0 when read, indicating that the OHCI registers are mapped into system memory space.

3.10 TI Extension Base Address Register

The TI extension base address register is programmed with a base address referencing the memory-mapped TI extension registers. When BIOS writes all 1s to this register, the value read back is FFFF C000h, indicating that at least 16K bytes of memory address space are required for the TI registers. See Table 3–9 for a complete description of the register contents.

Bit	31	30	29	28	27	26	25	24	23	22	21	20	19	18	17	16
Name	TI extension base address															
Type	R/W	R/W	R/W	R/W	R/W	R/W	R/W	R/W	R/W	R/W	R/W	R/W	R/W	R/W	R/W	R/W
Default	0	0	0	0	0	0	0	0	0	0	0	0	0	0	0	0
Bit	15	14	13	12	11	10	9	8	7	6	5	4	3	2	1	0
Name	TI extension base address															
Type	R/W	R/W	R	R	R	R	R	R	R	R	R	R	R	R	R	R
Default	0	0	0	0	0	0	0	0	0	0	0	0	0	0	0	0

Register: **TI extension base address**
 Offset: 14h
 Type: Read/Write, Read-Only
 Default: 0000 0000h

Table 3–9. TI Base Address Register Description

BIT	FIELD NAME	TYPE	DESCRIPTION
31–14	TIREG_PTR	R/W	TI register pointer. This field specifies the upper 18 bits of the 32-bit TI base address register.
13–4	TI_SZ	R	TI register size. This field returns 0s when read, indicating that the TI registers require a 16K-byte region of memory.
3	TI_PF	R	TI register prefetch. Bit 3 returns 0 when read, indicating that the TI registers are nonprefetchable.
2–1	TI_MEMTYPE	R	TI memory type. This field returns 0s when read, indicating that the TI base address register is 32 bits wide and mapping can be done anywhere in the 32-bit memory space.
0	TI_MEM	R	TI memory indicator. Bit 0 returns 0 when read, indicating that the TI registers are mapped into system memory space.

3.11 CardBus CIS Base Address Register

If $\overline{\text{CARDBUS}}$ is sampled high on a $\overline{\text{G_RST}}$, this 32-bit register returns 0s when read. If $\overline{\text{CARDBUS}}$ is sampled low, this register is programmed with a base address referencing the memory-mapped card information structure (CIS). This register must be programmed with a nonzero value before the CIS can be accessed. See Table 3–10 for a complete description of the register contents.

Bit	31	30	29	28	27	26	25	24	23	22	21	20	19	18	17	16
Name	CardBus CIS base address															
Type	R/W	R/W	R/W	R/W	R/W	R/W	R/W	R/W	R/W	R/W	R/W	R/W	R/W	R/W	R/W	R/W
Default	0	0	0	0	0	0	0	0	0	0	0	0	0	0	0	0
Bit	15	14	13	12	11	10	9	8	7	6	5	4	3	2	1	0
Name	CardBus CIS base address															
Type	R/W	R/W	R/W	R/W	R/W	R	R	R	R	R	R	R	R	R	R	R
Default	0	0	0	0	0	0	0	0	0	0	0	0	0	0	0	0

Register: **CardBus CIS base address**

Offset: 18h

Type: Read/Write, Read-Only

Default: 0000 0000h

Table 3–10. CardBus CIS Base Address Register Description

BIT	FIELD NAME	TYPE	DESCRIPTION
31–11	CIS_BASE	R/W	CIS base address. This field specifies the upper 21 bits of the 32-bit CIS base address. If $\overline{\text{CARDBUS}}$ is sampled high on a $\overline{\text{G_RST}}$, this field is read-only, returning 0s when read.
10–4	CIS_SZ	R	CIS address space size. This field returns 0s when read, indicating that the CIS space requires a 2K-byte region of memory.
3	CIS_PF	R	CIS prefetch. Bit 3 returns 0 when read, indicating that the CIS is nonprefetchable. Furthermore, the CIS is a byte-accessible address space, and either a doubleword or 16-bit word access yields indeterminate results.
2–1	CIS_MEMTYPE	R	CIS memory type. This field returns 0s when read, indicating that the CardBus CIS base address register is 32 bits wide and mapping can be done anywhere in the 32-bit memory space.
0	CIS_MEM	R	CIS memory indicator. Bit 0 returns 0 when read, indicating that the CIS is mapped into system memory space.

3.12 CardBus CIS Pointer Register

$\overline{\text{CARDBUS}}$ to the TSB43AB21A device is sampled at $\overline{\text{G_RST}}$ to determine the TSB43AB21A application. If $\overline{\text{CARDBUS}}$ is sampled high, this register is read-only returning 0s when read. If $\overline{\text{CARDBUS}}$ is sampled low, this register contains the pointer to the CardBus card information structure (CIS). See Table 3–11 for a complete description of the register contents.

Bit	31	30	29	28	27	26	25	24	23	22	21	20	19	18	17	16
Name	CardBus CIS pointer															
Type	R	R	R	R	R	R	R	R	R	R	R	R	R	R	R	R
Default	0	0	0	0	0	0	0	0	0	0	0	0	0	0	0	0
Bit	15	14	13	12	11	10	9	8	7	6	5	4	3	2	1	0
Name	CardBus CIS pointer															
Type	R	R	R	R	R	R	R	R	R	R	R	R	R	R	R	R
Default	0	0	0	0	0	0	0	0	0	0	0	0	0	0	0	0

Register: **CardBus CIS pointer**
 Offset: 28h
 Type: Read-Only
 Default: 0000 0000h

Table 3–11. CardBus CIS Pointer Register Description

BIT	FIELD NAME	TYPE	DESCRIPTION
31–28	ROM_IMAGE	R	Since the CIS is not implemented as a ROM image, this field returns 0s when read.
27–3	CIS_OFFSET	R	This field indicates the offset into the CIS address space where the CIS begins, and bits 7–3 are loaded from the serial EEPROM field CIS_Offset (7–3). This implementation allows the TSB43AB21A device to produce serial EEPROM addresses equal to the lower PCI address byte to acquire data from the serial EEPROM.
2–0	CIS_INDICATOR	R	This field indicates the address space where the CIS resides and returns 011b if $\overline{\text{CARDBUS}}$ is sampled low at $\overline{\text{G_RST}}$. 011b indicates that CardBus CIS base address register at offset 18h in the PCI configuration header contains the CIS base address. If $\overline{\text{CARDBUS}}$ is sampled high at $\overline{\text{G_RST}}$, this field contains 000b.

3.13 Subsystem Identification Register

The subsystem identification register is used for system and option card identification purposes. This register can be initialized from the serial EEPROM or programmed via the subsystem access register at offset F8h in the PCI configuration space (see Section 3.25, *Subsystem Access Register*). See Table 3–12 for a complete description of the register contents.

Bit	31	30	29	28	27	26	25	24	23	22	21	20	19	18	17	16
Name	Subsystem identification															
Type	RU	RU	RU	RU	RU	RU	RU	RU	RU	RU	RU	RU	RU	RU	RU	RU
Default	0	0	0	0	0	0	0	0	0	0	0	0	0	0	0	0
Bit	15	14	13	12	11	10	9	8	7	6	5	4	3	2	1	0
Name	Subsystem identification															
Type	RU	RU	RU	RU	RU	RU	RU	RU	RU	RU	RU	RU	RU	RU	RU	RU
Default	0	0	0	0	0	0	0	0	0	0	0	0	0	0	0	0

Register: **Subsystem identification**

Offset: 2Ch

Type: Read/Update

Default: 0000 0000h

Table 3–12. Subsystem Identification Register Description

BIT	FIELD NAME	TYPE	DESCRIPTION
31–16	OHCI_SSID	RU	Subsystem device ID. This field indicates the subsystem device ID.
15–0	OHCI_SVID	RU	Subsystem vendor ID. This field indicates the subsystem vendor ID.

3.14 Power Management Capabilities Pointer Register

The power management capabilities pointer register provides a pointer into the PCI configuration header where the power-management register block resides. The TSB43AB21A configuration header doublewords at offsets 44h and 48h provide the power-management registers. This register is read-only and returns 44h when read.

Bit	7	6	5	4	3	2	1	0
Name	Power management capabilities pointer							
Type	R	R	R	R	R	R	R	R
Default	0	1	0	0	0	1	0	0

Register: **Power management capabilities pointer**

Offset: 34h

Type: Read-Only

Default: 44h

3.15 Interrupt Line and Pin Register

The interrupt line and pin register communicates interrupt line routing information. See Table 3–13 for a complete description of the register contents.

Bit	15	14	13	12	11	10	9	8	7	6	5	4	3	2	1	0
Name	Interrupt line and pin															
Type	R	R	R	R	R	R	R	R	R/W	R/W	R/W	R/W	R/W	R/W	R/W	R/W
Default	0	0	0	0	0	0	0	1	0	0	0	0	0	0	0	0

Register: **Interrupt line and pin**
 Offset: 3Ch
 Type: Read/Write
 Default: 0100h

Table 3–13. Interrupt Line and Pin Registers Description

BIT	FIELD NAME	TYPE	DESCRIPTION
15–8	INTR_PIN	R	Interrupt pin. This field returns 01h when read, indicating that the TSB43AB21A PCI function signals interrupts on the PCI_INTA terminal.
7–0	INTR_LINE	R/W	Interrupt line. This field is programmed by the system and indicates to software which interrupt line the TSB43AB21A PCI_INTA is connected to.

3.16 MIN_GNT and MAX_LAT Register

The MIN_GNT and MAX_LAT register communicates to the system the desired setting of bits 15–8 in the latency timer and class cache line size register at offset 0Ch in the PCI configuration space (see Section 3.7, *Latency Timer and Class Cache Line Size Register*). If a serial EEPROM is detected, the contents of this register are loaded through the serial EEPROM interface after a $\overline{G_RST}$. If no serial EEPROM is detected, this register returns a default value that corresponds to the MAX_LAT = 4, MIN_GNT = 2. See Table 3–14 for a complete description of the register contents.

Bit	15	14	13	12	11	10	9	8	7	6	5	4	3	2	1	0
Name	MIN_GNT and MAX_LAT															
Type	RU	RU	RU	RU	RU	RU	RU	RU	RU	RU	RU	RU	RU	RU	RU	RU
Default	0	0	0	0	0	1	0	0	0	0	0	0	0	0	1	0

Register: **MIN_GNT and MAX_LAT**
 Offset: 3Eh
 Type: Read/Update
 Default: 0402h

Table 3–14. MIN_GNT and MAX_LAT Register Description

BIT	FIELD NAME	TYPE	DESCRIPTION
15–8	MAX_LAT	RU	Maximum latency. The contents of this field may be used by host BIOS to assign an arbitration priority level to the TSB43AB21A device. The default for this register indicates that the TSB43AB21A device may need to access the PCI bus as often as every 0.25 μ s; thus, an extremely high priority level is requested. The contents of this field may also be loaded through the serial EEPROM.
7–0	MIN_GNT	RU	Minimum grant. The contents of this field may be used by host BIOS to assign a latency timer register value to the TSB43AB21A device. The default for this register indicates that the TSB43AB21A device may need to sustain burst transfers for nearly 64 μ s and thus request a large value be programmed in bits 15–8 of the TSB43AB21A latency timer and class cache line size register at offset 0Ch in the PCI configuration space (see Section 3.7, <i>Latency Timer and Class Cache Line Size Register</i>).

3.17 OHCI Control Register

The PCI OHCI control register is defined by the *1394 Open Host Controller Interface Specification* and provides a bit for big endian PCI support. See Table 3–15 for a complete description of the register contents.

Bit	31	30	29	28	27	26	25	24	23	22	21	20	19	18	17	16
Name	OHCI control															
Type	R	R	R	R	R	R	R	R	R	R	R	R	R	R	R	R
Default	0	0	0	0	0	0	0	0	0	0	0	0	0	0	0	0
Bit	15	14	13	12	11	10	9	8	7	6	5	4	3	2	1	0
Name	OHCI control															
Type	R	R	R	R	R	R	R	R	R	R	R	R	R	R	R	R/W
Default	0	0	0	0	0	0	0	0	0	0	0	0	0	0	0	0

Register: **OHCI control**
 Offset: 40h
 Type: Read/Write, read-only
 Default: 0000 0000h

Table 3–15. OHCI Control Register Description

BIT	FIELD NAME	TYPE	DESCRIPTION
31–1	RSVD	R	Reserved. Bits 31–1 return 0s when read.
0	GLOBAL_SWAP	R/W	When bit 0 is set to 1, all quadlets read from and written to the PCI interface are byte-swapped (big endian).

3.18 Capability ID and Next Item Pointer Registers

The capability ID and next item pointer register identifies the linked-list capability item and provides a pointer to the next capability item. See Table 3–16 for a complete description of the register contents.

Bit	15	14	13	12	11	10	9	8	7	6	5	4	3	2	1	0
Name	Capability ID and next item pointer															
Type	R	R	R	R	R	R	R	R	R	R	R	R	R	R	R	R
Default	0	0	0	0	0	0	0	0	0	0	0	0	0	0	0	1

Register: **Capability ID and next item pointer**
 Offset: 44h
 Type: Read-Only
 Default: 0001h

Table 3–16. Capability ID and Next Item Pointer Registers Description

BIT	FIELD NAME	TYPE	DESCRIPTION
15–8	NEXT_ITEM	R	Next item pointer. The TSB43AB21A device supports only one additional capability that is communicated to the system through the extended capabilities list; therefore, this field returns 00h when read.
7–0	CAPABILITY_ID	R	Capability identification. This field returns 01h when read, which is the unique ID assigned by the PCI SIG for PCI power-management capability.

3.19 Power Management Capabilities Register

The power management capabilities register indicates the capabilities of the TSB43AB21A device related to PCI power management. See Table 3–17 for a complete description of the register contents.

Bit	15	14	13	12	11	10	9	8	7	6	5	4	3	2	1	0
Name	Power management capabilities															
Type	RU	R	R	R	R	R	R	R	R	R	R	R	R	R	R	R
Default	0	1	1	1	1	1	1	0	0	0	0	0	0	0	1	0

Register: **Power management capabilities**
 Offset: 46h
 Type: Read/Update, Read-Only
 Default: 7E02h

Table 3–17. Power Management Capabilities Register Description

BIT	FIELD NAME	TYPE	DESCRIPTION
15	PME_D3COLD	RU	$\overline{\text{PCI_PME}}$ support from D3 _{cold} . This bit can be set to 1 or cleared to 0 via bit 15 (PME_D3COLD) in the miscellaneous configuration register at offset F0h in the PCI configuration space (see Section 3.23, <i>Miscellaneous Configuration Register</i>). The miscellaneous configuration register is loaded from ROM. When this bit is set to 1, it indicates that the TSB43AB21A device is capable of generating a $\overline{\text{PCI_PME}}$ wake event from D3 _{cold} . This bit state is dependent upon the TSB43AB21A V _{AUX} implementation and may be configured by using bit 15 (PME_D3COLD) in the miscellaneous configuration register (see Section 3.23).
14–11	PME_SUPPORT	R	$\overline{\text{PCI_PME}}$ support. This 4-bit field indicates the power states from which the TSB43AB21A device may assert $\overline{\text{PCI_PME}}$. This field returns a value of 1111b by default, indicating that $\overline{\text{PCI_PME}}$ may be asserted from the D3 _{hot} , D2, D1, and D0 power states.
10	D2_SUPPORT	R	D2 support. Bit 10 is hardwired to 1, indicating that the TSB43AB21A device supports the D2 power state.
9	D1_SUPPORT	R	D1 support. Bit 9 is hardwired to 1, indicating that the TSB43AB21A device supports the D1 power state.
8–6	AUX_CURRENT	R	Auxiliary current. This 3-bit field reports the 3.3-V _{AUX} auxiliary current requirements. When bit 15 (PME_D3COLD) is cleared, this field returns 000b; otherwise, it returns 001b. 000b = Self-powered 001b = 55 mA (3.3-V _{AUX} maximum current required)
5	DSI	R	Device-specific initialization. This bit returns 0 when read, indicating that the TSB43AB21A device does not require special initialization beyond the standard PCI configuration header before a generic class driver is able to use it.
4	RSVD	R	Reserved. Bit 4 returns 0 when read.
3	PME_CLK	R	$\overline{\text{PCI_PME}}$ clock. This bit returns 0 when read, indicating that no host bus clock is required for the TSB43AB21A device to generate $\overline{\text{PCI_PME}}$.
2–0	PM_VERSION	R	Power-management version. This field returns 010b when read, indicating that the TSB43AB21A device is compatible with the registers described in the <i>PCI Bus Power Management Interface Specification</i> (Revision 1.1).

3.20 Power Management Control and Status Register

The power management control and status register implements the control and status of the PCI power management function. This register is not affected by the internally generated reset caused by the transition from the D3_{hot} to D0 state. See Table 3–18 for a complete description of the register contents.

Bit	15	14	13	12	11	10	9	8	7	6	5	4	3	2	1	0
Name	Power management control and status															
Type	RWC	R	R	R	R	R	R	R/W	R	R	R	R	R	R	R/W	R/W
Default	0	0	0	0	0	0	0	0	0	0	0	0	0	0	0	0

Register: **Power management control and status**
 Offset: 48h
 Type: Read/Clear, Read/Write, Read-Only
 Default: 0000h

Table 3–18. Power Management Control and Status Register Description

BIT	FIELD NAME	TYPE	DESCRIPTION
15	PME_STS	RWC	Bit 15 is set to 1 when the TSB43AB21A device normally asserts the $\overline{\text{PCI_PME}}$ signal independent of the state of bit 8 (PME_ENB). This bit is cleared by a writeback of 1, which also clears the $\overline{\text{PCI_PME}}$ signal driven by the TSB43AB21A device. Writing a 0 to this bit has no effect.
14–13	DATA_SCALE	R	This field returns 0s, because the data register is not implemented.
12–9	DATA_SELECT	R	This field returns 0s, because the data register is not implemented.
8	PME_ENB	R/W	When bit 8 is set to 1, $\overline{\text{PME}}$ assertion is enabled. When bit 8 is cleared, $\overline{\text{PME}}$ assertion is disabled. This bit defaults to 0 if the function does not support $\overline{\text{PME}}$ generation from D3 _{Cold} . If the function supports $\overline{\text{PME}}$ from D3 _{Cold} , this bit is sticky and must be explicitly cleared by the operating system each time it is initially loaded.
7–2	RSVD	R	Reserved. Bits 7–2 return 0s when read.
1–0	PWR_STATE	R/W	Power state. This 2-bit field sets the TSB43AB21A device power state and is encoded as follows: 00 = Current power state is D0. 01 = Current power state is D1. 10 = Current power state is D2. 11 = Current power state is D3.

3.21 Power Management Extension Registers

The power management extension register provides extended power-management features not applicable to the TSB43AB21A device; thus, it is read-only and returns 0 when read. See Table 3–19 for a complete description of the register contents.

Bit	15	14	13	12	11	10	9	8	7	6	5	4	3	2	1	0
Name	Power management extension															
Type	R	R	R	R	R	R	R	R	R	R	R	R	R	R	R	R
Default	0	0	0	0	0	0	0	0	0	0	0	0	0	0	0	0

Register: **Power management extension**
 Offset: 4Ah
 Type: Read-Only
 Default: 0000h

Table 3–19. Power Management Extension Registers Description

BIT	FIELD NAME	TYPE	DESCRIPTION
15–0	RSVD	R	Reserved. Bits 15–0 return 0s when read.

3.22 PCI PHY Control Register

The PCI PHY control register provides a method for enabling the PHY CNA output. See Table 3–20 for a complete description of the register contents.

Bit	31	30	29	28	27	26	25	24	23	22	21	20	19	18	17	16
Name	PCI PHY control															
Type	R	R	R	R	R	R	R	R	R	R	R	R	R	R	R	R
Default	0	0	0	0	0	0	0	0	0	0	0	0	0	0	0	0
Bit	15	14	13	12	11	10	9	8	7	6	5	4	3	2	1	0
Name	PCI PHY control															
Type	R	R	R	R	R	R	R	R	R/W	R	R	R	R/W	R	R	R
Default	0	0	0	0	0	0	0	0	0	0	0	0	1	0	0	0

Register: **PCI PHY control**
 Offset: ECh
 Type: Read/Write, Read-Only
 Default: 0000 0008h

Table 3–20. PCI PHY Control Register

BIT	FIELD NAME	TYPE	DESCRIPTION
31–8	RSVD	R	Reserved. Bits 31–8 return 0s when read.
7	CNAOUT	R/W	When bit 7 is set to 1, the PHY CNA output is routed to terminal 96. When implementing a serial EEPROM, this bit can be set by programming bit 7 of offset 16h in the EEPROM to 1.
6–4	RSVD	R	Reserved. Bits 6–4 return 0s when read. These bits are affected when implementing a serial EEPROM; thus, bits 6–4 at EEPROM byte offset 16h must be programmed to 0.
3	RSVD	R/W	Reserved. Bit 3 defaults to 1 to indicate compliance with IEEE Std 1394a-2000. If a serial EEPROM is implemented, bit 3 at EEPROM byte offset 16h must be set to 1. See Table 6–2, <i>Serial EEPROM Map</i> .
2–0	RSVD	R	Reserved. Bits 2–0 return 0s when read. These bits are affected when implementing a serial EEPROM; thus, bits 2–0 at EEPROM byte offset 16h must be programmed to 0.

3.23 Miscellaneous Configuration Register

The miscellaneous configuration register provides miscellaneous PCI-related configuration. See Table 3–21 for a complete description of the register contents.

Bit	31	30	29	28	27	26	25	24	23	22	21	20	19	18	17	16
Name	Miscellaneous configuration															
Type	R	R	R	R	R	R	R	R	R	R	R	R	R	R	R	R
Default	0	0	0	0	0	0	0	0	0	0	0	0	0	0	0	0
Bit	15	14	13	12	11	10	9	8	7	6	5	4	3	2	1	0
Name	Miscellaneous configuration															
Type	R/W	R	R/W	R	R	R/W	R	R	R	R	R	R/W	R/W	R/W	R/W	R/W
Default	0	0	0	0	0	0	0	0	0	0	0	0	0	0	0	0

Register: **Miscellaneous configuration**
 Offset: F0h
 Type: Read/Write, Read-Only
 Default: 0000 0000h

Table 3–21. Miscellaneous Configuration Register

BIT	FIELD NAME	TYPE	DESCRIPTION
31–16	RSVD	R	Reserved. Bits 31–16 return 0s when read.
15	PME_D3COLD	R/W	PCI_PME support from D3 _{cold} . This bit programs bit 15 (PME_D3COLD) in the power management capabilities register at offset 46h in the PCI configuration space (see Section 3.19, <i>Power Management Capabilities Register</i>).
14–5	RSVD	R	Reserved. Bits 14–5 return 0s when read.
4	DIS_TGT_ABT	R/W	Bit 4 defaults to 0, which provides iOHCI-Lynx™ compatible target abort signaling. When this bit is set to 1, it enables the no-target-abort mode, in which the TSB43AB21A device returns indeterminate data instead of signaling target abort. The TSB43AB21A LLC is divided into the PCI_CLK and SCLK domains. If software tries to access registers in the link that are not active because the SCLK is disabled, a target abort is issued by the link. On some systems, this can cause a problem resulting in a fatal system error. Enabling this bit allows the link to respond to these types of requests by returning FFh. It is recommended that this bit be set to 1.
3	GP2IIC	R/W	When bit 3 is set to 1, the GPIO3 and GPIO2 signals are internally routed to the SCL and SDA, respectively. The GPIO3 and GPIO2 terminals are also placed in the high-impedance state.
2	DISABLE_SCLKGATE	R/W	When bit 2 is set to 1, the internal SCLK runs identically with the chip input. This is a test feature only and must be cleared to 0 (all applications).
1	DISABLE_PCIGATE	R/W	When bit 1 is set to 1, the internal PCI clock runs identically with the chip input. This is a test feature only and must be cleared to 0 (all applications).
0	KEEP_PCLK	R/W	When bit 0 is set to 1, the PCI clock is always kept running through the PCI_CLKRUN protocol. When this bit is cleared, the PCI clock can be stopped using PCI_CLKRUN.

3.24 Link Enhancement Control Register

The link enhancement control register implements TI proprietary bits that are initialized by software or by a serial EEPROM, if present. After these bits are set to 1, their functionality is enabled only if bit 22 (aPhyEnhanceEnable) in the host controller control register at OHCI offset 50h/54h (see Section 4.16, *Host Controller Control Register*) is set to 1. See Table 3–22 for a complete description of the register contents.

Bit	31	30	29	28	27	26	25	24	23	22	21	20	19	18	17	16
Name	Link enhancement control															
Type	R	R	R	R	R	R	R	R	R	R	R	R	R	R	R	R
Default	0	0	0	0	0	0	0	0	0	0	0	0	0	0	0	0
Bit	15	14	13	12	11	10	9	8	7	6	5	4	3	2	1	0
Name	Link enhancement control															
Type	R/W	R	R/W	R/W	R	R/W	R	R/W	R/W	R	R	R	R	R	R/W	R
Default	0	0	0	1	0	0	0	0	0	0	0	0	0	0	0	0

Register: **Link enhancement control**
 Offset: F4h
 Type: Read/Write, read-only
 Default: 0000 1000h

Table 3–22. Link Enhancement Control Register Description

BIT	FIELD NAME	TYPE	DESCRIPTION
31–16	RSVD	R	Reserved. Bits 31–16 return 0s when read.
15	dis_at_pipeline	R/W	Disable AT pipelining. When bit 15 is set to 1, out-of-order AT pipelining is disabled.
14	RSVD	R	Reserved.
13–12	atx_thresh	R/W	<p>This field sets the initial AT threshold value, which is used until the AT FIFO is underrun. When the TSB43AB21A device retries the packet, it uses a 2K-byte threshold, resulting in a store-and-forward operation.</p> <p>00 = Threshold ~ 2K bytes resulting in a store-and-forward operation 01 = Threshold ~ 1.7K bytes (default) 10 = Threshold ~ 1K bytes 11 = Threshold ~ 512 bytes</p> <p>These bits fine-tune the asynchronous transmit threshold. For most applications the 1.7K-byte threshold is optimal. Changing this value may increase or decrease the 1394 latency depending on the average PCI bus latency.</p> <p>Setting the AT threshold to 1.7K, 1K, or 512 bytes results in data being transmitted at these thresholds or when an entire packet has been checked into the FIFO. If the packet to be transmitted is larger than the AT threshold, the remaining data must be received before the AT FIFO is emptied; otherwise, an underrun condition occurs, resulting in a packet error at the receiving node. As a result, the link then commences store-and-forward operation. Wait until it has the complete packet in the FIFO before retransmitting it on the second attempt to ensure delivery.</p> <p>An AT threshold of 2K results in store-and-forward operation, which means that asynchronous data is not transmitted until an end-of-packet token is received. Restated, setting the AT threshold to 2K results in only complete packets being transmitted.</p> <p>Note that this device always uses store-and-forward when the asynchronous transmit retries register at OHCI offset 08h (see Section 4.3, <i>Asynchronous Transmit Retries Register</i>) is cleared.</p>
11	RSVD	R	Reserved. Bit 11 returns 0 when read.
10	enab_mpeg_ts	R/W	Enable MPEG CIP timestamp enhancement. When bit 9 is set to 1, the enhancement is enabled for MPEG CIP transmit streams (FMT = 20h).
9	RSVD	R	Reserved. Bit 9 returns 0 when read.
8	enab_dv_ts	R/W	Enable DV CIP timestamp enhancement. When bit 8 is set to 1, the enhancement is enabled for DV CIP transmit streams (FMT = 00h).
7	enab_unfair	R/W	Enable asynchronous priority requests. iOHCI-Lynx™ compatible. Setting bit 7 to 1 enables the link to respond to requests with priority arbitration. It is recommended that this bit be set to 1.

Table 3–22. Link Enhancement Control Register Description (Continued)

BIT	FIELD NAME	TYPE	DESCRIPTION
6	RSVD	R	This bit is not assigned in the TSB43AB21A follow-on products, because this bit location loaded by the serial EEPROM from the enhancements field corresponds to bit 23 (programPhyEnable) in the host controller control register at OHCI offset 50h/54h (see Section 4.16, <i>Host Controller Control Register</i>).
5–2	RSVD	R	Reserved. Bits 5–2 return 0s when read.
1	enab_accel	R/W	Enable acceleration enhancements. iOHCI-Lynx™ compatible. When bit 1 is set to 1, the PHY layer is notified that the link supports the IEEE Std 1394a-2000 acceleration enhancements, that is, ack-accelerated, fly-by concatenation, etc. It is recommended that this bit be set to 1.
0	RSVD	R	Reserved. Bit 0 returns 0 when read.

3.25 Subsystem Access Register

Write access to the subsystem access register updates the subsystem identification registers identically to iOHCI-Lynx™. The system ID value written to this register may also be read back from this register. See Table 3–23 for a complete description of the register contents.

Bit	31	30	29	28	27	26	25	24	23	22	21	20	19	18	17	16
Name	Subsystem access															
Type	R/W	R/W	R/W	R/W	R/W	R/W	R/W	R/W	R/W	R/W	R/W	R/W	R/W	R/W	R/W	R/W
Default	0	0	0	0	0	0	0	0	0	0	0	0	0	0	0	0
Bit	15	14	13	12	11	10	9	8	7	6	5	4	3	2	1	0
Name	Subsystem access															
Type	R/W	R/W	R/W	R/W	R/W	R/W	R/W	R/W	R/W	R/W	R/W	R/W	R/W	R/W	R/W	R/W
Default	0	0	0	0	0	0	0	0	0	0	0	0	0	0	0	0

Register: **Subsystem access**
 Offset: F8h
 Type: Read/Write
 Default: 0000 0000h

Table 3–23. Subsystem Access Register Description

BIT	FIELD NAME	TYPE	DESCRIPTION
31–16	SUBDEV_ID	R/W	Subsystem device ID alias. This field indicates the subsystem device ID.
15–0	SUBVEN_ID	R/W	Subsystem vendor ID alias. This field indicates the subsystem vendor ID.

3.26 GPIO Control Register

The GPIO control register has the control and status bits for the GPIO2 and GPIO3 ports. See Table 3–24 for a complete description of the register contents.

Bit	31	30	29	28	27	26	25	24	23	22	21	20	19	18	17	16
Name	GPIO control															
Type	R/W	R	R/W	R/W	R	R	R	RWU	R/W	R	R/W	R/W	R	R	R	RWU
Default	0	0	0	0	0	0	0	0	0	0	0	0	0	0	0	0
Bit	15	14	13	12	11	10	9	8	7	6	5	4	3	2	1	0
Name	GPIO control															
Type	R	R	R	R	R	R	R	R	R	R	R	R	R	R	R	R
Default	0	0	0	0	0	0	0	0	0	0	0	0	0	0	0	0

Register: **GPIO control**
 Offset: FCh
 Type: Read/Write/Update, read/write, read-only
 Default: 0000 0000h

Table 3–24. General-Purpose Input/Output Control Register Description

BIT	FIELD NAME	TYPE	DESCRIPTION
31	INT_3EN	R/W	When bit 31 is set to 1, a TSB43AB21A general-purpose interrupt event occurs on a level change of the GPIO3 input. This event can generate an interrupt, with mask and event status reported through the interrupt mask register at OHCI offset 88h/8Ch (see Section 4.22, <i>Interrupt Mask Register</i>) and interrupt event register at OHCI offset 80h/84h (see Section 4.21, <i>Interrupt Event Register</i>).
30	RSVD	R	Reserved. Bit 30 returns 0 when read.
29	GPIO_INV3	R/W	GPIO3 polarity invert. When bit 29 is set to 1, the polarity of GPIO3 is inverted.
28	GPIO_ENB3	R/W	GPIO3 enable control. When bit 28 is set to 1, the output is enabled. Otherwise, the output is high impedance.
27–25	RSVD	R	Reserved. Bits 27–25 return 0s when read.
24	GPIO_DATA3	RWU	GPIO3 data. Reads from bit 24 return the logical value of the input to GPIO3. Writes to this bit update the value to drive to GPIO3 when output is enabled.
23	INT_2EN	R/W	When bit 23 is set to 1, a TSB43AB21A general-purpose interrupt event occurs on a level change of the GPIO2 input. This event can generate an interrupt, with mask and event status reported through the interrupt mask register at OHCI offset 88h/8Ch (see Section 4.22, <i>Interrupt Mask Register</i>) and interrupt event register at OHCI offset 80h/84h (see Section 4.21, <i>Interrupt Event Register</i>).
22	RSVD	R	Reserved. Bit 22 returns 0 when read.
21	GPIO_INV2	R/W	GPIO2 polarity invert. When bit 21 is set to 1, the polarity of GPIO2 is inverted.
20	GPIO_ENB2	R/W	GPIO2 enable control. When bit 20 is set to 1, the output is enabled. Otherwise, the output is high impedance.
19–17	RSVD	R	Reserved. Bits 19–17 return 0s when read.
16	GPIO_DATA2	RWU	GPIO2 data. Reads from bit 16 return the logical value of the input to GPIO2. Writes to this bit update the value to drive to GPIO2 when the output is enabled.
15–0	RSVD	R	Reserved. Bits 15–0 return 0s when read.

4 OHCI Registers

The OHCI registers defined by the *1394 Open Host Controller Interface Specification* are memory-mapped into a 2K-byte region of memory pointed to by the OHCI base address register at offset 10h in PCI configuration space (see section 3.9, *OHCI Base Address Register*). These registers are the primary interface for controlling the TSB43AB21A IEEE 1394 link function.

This section provides the register interface and bit descriptions. Several set/clear register pairs in this programming model are implemented to solve various issues with typical read-modify-write control registers. There are two addresses for a set/clear register: RegisterSet and RegisterClear. See Table 4–1 for a register listing. A 1 bit written to RegisterSet causes the corresponding bit in the set/clear register to be set to 1; a 0 bit leaves the corresponding bit unaffected. A 1 bit written to RegisterClear causes the corresponding bit in the set/clear register to be cleared; a 0 bit leaves the corresponding bit in the set/clear register unaffected.

Typically, a read from either RegisterSet or RegisterClear returns the contents of the set or clear register, respectively. However, sometimes reading the RegisterClear provides a masked version of the set or clear register. The interrupt event register is an example of this behavior.

Table 4–1. OHCI Register Map

DMA CONTEXT	REGISTER NAME	ABBREVIATION	OFFSET	
—	OHCI version	Version	00h	
	GUID ROM	GUID_ROM	04h	
	Asynchronous transmit retries	ATRetries	08h	
	CSR data	CSRData	0Ch	
	CSR compare	CSRCompareData	10h	
	CSR control	CSRControl	14h	
	Configuration ROM header	ConfigROMhdr	18h	
	Bus identification	BusID	1Ch	
	Bus options	BusOptions	20h	
	GUID high	GUIDHi	24h	
	GUID low	GUIDLo	28h	
	Reserved	—	2Ch–30h	
	Configuration ROM mapping	ConfigROMmap	34h	
	Posted write address low	PostedWriteAddressLo	38h	
	Posted write address high	PostedWriteAddressHi	3Ch	
	Vendor ID	VendorID	40h	
	Reserved	—	44h–4Ch	
	Host controller control	HCControlSet		50h
		HCControlClr		54h
	Reserved	—	58h–5Ch	

Table 4–1. OHCI Register Map (Continued)

DMA CONTEXT	REGISTER NAME	ABBREVIATION	OFFSET
Self-ID	Reserved	—	60h
	Self-ID buffer pointer	SelfIDBuffer	64h
	Self-ID count	SelfIDCount	68h
	Reserved	—	6Ch
—	Isochronous receive channel mask high	IRChannelMaskHiSet	70h
		IRChannelMaskHiClear	74h
	Isochronous receive channel mask low	IRChannelMaskLoSet	78h
		IRChannelMaskLoClear	7Ch
	Interrupt event	IntEventSet	80h
		IntEventClear	84h
	Interrupt mask	IntMaskSet	88h
		IntMaskClear	8Ch
	Isochronous transmit interrupt event	IsoXmitIntEventSet	90h
		IsoXmitIntEventClear	94h
	Isochronous transmit interrupt mask	IsoXmitIntMaskSet	98h
		IsoXmitIntMaskClear	9Ch
—	Isochronous receive interrupt event	IsoRecvIntEventSet	A0h
		IsoRecvIntEventClear	A4h
	Isochronous receive interrupt mask	IsoRecvIntMaskSet	A8h
		IsoRecvIntMaskClear	ACh
	Initial bandwidth available	InitialBandwidthAvailable	B0h
	Initial channels available high	InitialChannelsAvailableHi	B4h
	Initial channels available low	InitialChannelsAvailableLo	B8h
	Reserved	—	BCh–D8h
	Fairness control	FairnessControl	DCh
	Link control	LinkControlSet	E0h
		LinkControlClear	E4h
	Node identification	NodeID	E8h
	PHY layer control	PhyControl	ECh
	Isochronous cycle timer	Isocyc timer	F0h
	Reserved	—	F4h–FCh
	Asynchronous request filter high	AsyncRequestFilterHiSet	100h
		AsyncRequestFilterHiClear	104h
	Asynchronous request filter low	AsyncRequestFilterLoSet	108h
		AsyncRequestFilterLoClear	10Ch
	Physical request filter high	PhysicalRequestFilterHiSet	110h
		PhysicalRequestFilterHiClear	114h
	Physical request filter low	PhysicalRequestFilterLoSet	118h
PhysicalRequestFilterLoClear		11Ch	
Physical upper bound	PhysicalUpperBound	120h	
Reserved	—	124h–17Ch	

Table 4–1. OHCI Register Map (Continued)

DMA CONTEXT	REGISTER NAME	ABBREVIATION	OFFSET
Asynchronous Request Transmit [ATRQ]	Asynchronous context control	ContextControlSet	180h
		ContextControlClear	184h
	Reserved	—	188h
	Asynchronous context command pointer	CommandPtr	18Ch
	Reserved	—	190h–19Ch
Asynchronous Response Transmit [ATRS]	Asynchronous context control	ContextControlSet	1A0h
		ContextControlClear	1A4h
	Reserved	—	1A8h
	Asynchronous context command pointer	CommandPtr	1ACh
	Reserved	—	1B0h–1BCh
Asynchronous Request Receive [ARRQ]	Asynchronous context control	ContextControlSet	1C0h
		ContextControlClear	1C4h
	Reserved	—	1C8h
	Asynchronous context command pointer	CommandPtr	1CCh
	Reserved	—	1D0h–1DCh
Asynchronous Response Receive [ARRS]	Asynchronous context control	ContextControlSet	1E0h
		ContextControlClear	1E4h
	Reserved	—	1E8h
	Asynchronous context command pointer	CommandPtr	1ECh
	Reserved	—	1F0h–1FCh
Isochronous Transmit Context n n = 0, 1, 2, 3, ..., 7	Isochronous transmit context control	ContextControlSet	200h + 16 x n
		ContextControlClear	204h + 16 x n
	Reserved	—	208h + 16 x n
	Isochronous transmit context command pointer	CommandPtr	20Ch + 16 x n
	Reserved	—	210h–3FCh
Isochronous Receive Context n n = 0, 1, 2, 3	Isochronous receive context control	ContextControlSet	400h + 32 x n
		ContextControlClear	404h + 32 x n
	Reserved	—	408h + 32 x n
	Isochronous receive context command pointer	CommandPtr	40Ch + 32 x n
	Isochronous receive context match	ContextMatch	410h + 32 x n

4.1 OHCI Version Register

The OHCI version register indicates the OHCI version support and whether or not the serial EEPROM is present. See Table 4–2 for a complete description of the register contents.

Bit	31	30	29	28	27	26	25	24	23	22	21	20	19	18	17	16
Name	OHCI version															
Type	R	R	R	R	R	R	R	R	R	R	R	R	R	R	R	R
Default	0	0	0	0	0	0	0	X	0	0	0	0	0	0	0	1
Bit	15	14	13	12	11	10	9	8	7	6	5	4	3	2	1	0
Name	OHCI version															
Type	R	R	R	R	R	R	R	R	R	R	R	R	R	R	R	R
Default	0	0	0	0	0	0	0	0	0	0	0	1	0	0	0	0

Register: **OHCI version**
 Offset: 00h
 Type: Read-only
 Default: 0X01 0010h

Table 4–2. OHCI Version Register Description

BIT	FIELD NAME	TYPE	DESCRIPTION
31–25	RSVD	R	Reserved. Bits 31–25 return 0s when read.
24	GUID_ROM	R	The TSB43AB21A device sets bit 24 to 1 if the serial EEPROM is detected. If the serial EEPROM is present, the Bus_Info_Block is automatically loaded on system (hardware) reset.
23–16	version	R	Major version of the OHCI. The TSB43AB21A device is compliant with the <i>1394 Open Host Controller Interface Specification</i> (Revision 1.1); thus, this field reads 01h.
15–8	RSVD	R	Reserved. Bits 15–8 return 0s when read.
7–0	revision	R	Minor version of the OHCI. The TSB43AB21A device is compliant with the <i>1394 Open Host Controller Interface Specification</i> (Revision 1.1); thus, this field reads 10h.

4.2 GUID ROM Register

The GUID ROM register accesses the serial EEPROM, and is only applicable if bit 24 (GUID_ROM) in the OHCI version register at OHCI offset 00h (see Section 4.1, *OHCI Version Register*) is set to 1. See Table 4–3 for a complete description of the register contents.

Bit	31	30	29	28	27	26	25	24	23	22	21	20	19	18	17	16
Name	GUID ROM															
Type	RSU	R	R	R	R	R	RSU	R	RU	RU	RU	RU	RU	RU	RU	RU
Default	0	0	0	0	0	0	0	0	X	X	X	X	X	X	X	X
Bit	15	14	13	12	11	10	9	8	7	6	5	4	3	2	1	0
Name	GUID ROM															
Type	R	R	R	R	R	R	R	R	R	R	R	R	R	R	R	R
Default	0	0	0	0	0	0	0	0	0	0	0	0	0	0	0	0

Register: **GUID ROM**
 Offset: 04h
 Type: Read/Set/Update, read/update, read-only
 Default: 00XX 0000h

Table 4–3. GUID ROM Register Description

BIT	FIELD NAME	TYPE	DESCRIPTION
31	addrReset	RSU	Software sets bit 31 to 1 to reset the GUID ROM address to 0. When the TSB43AB21A device completes the reset, it clears this bit. The TSB43AB21A device does not automatically fill bits 23–16 (rdData field) with the 0 th byte.
30–26	RSVD	R	Reserved. Bits 30–26 return 0s when read.
25	rdStart	RSU	A read of the currently addressed byte is started when bit 25 is set to 1. This bit is automatically cleared when the TSB43AB21A device completes the read of the currently addressed GUID ROM byte.
24	RSVD	R	Reserved. Bit 24 returns 0 when read.
23–16	rdData	RU	This field contains the data read from the GUID ROM.
15–8	RSVD	R	Reserved. Bits 15–8 return 0s when read.
7–0	miniROM	R	The miniROM field defaults to 0 indicating that no mini-ROM is implemented. If bit 5 of EEPROM offset 6h is set to 1, this field returns 20h indicating that valid mini-ROM data begins at offset 20h of the GUID ROM.

4.3 Asynchronous Transmit Retries Register

The asynchronous transmit retries register indicates the number of times the TSB43AB21A device attempts a retry for asynchronous DMA request transmit and for asynchronous physical and DMA response transmit. See Table 4–4 for a complete description of the register contents.

Bit	31	30	29	28	27	26	25	24	23	22	21	20	19	18	17	16
Name	Asynchronous transmit retries															
Type	R	R	R	R	R	R	R	R	R	R	R	R	R	R	R	R
Default	0	0	0	0	0	0	0	0	0	0	0	0	0	0	0	0
Bit	15	14	13	12	11	10	9	8	7	6	5	4	3	2	1	0
Name	Asynchronous transmit retries															
Type	R	R	R	R	R/W	R/W	R/W	R/W	R/W	R/W	R/W	R/W	R/W	R/W	R/W	R/W
Default	0	0	0	0	0	0	0	0	0	0	0	0	0	0	0	0

Register: **Asynchronous transmit retries**
 Offset: 08h
 Type: Read/Write, read-only
 Default: 0000 0000h

Table 4–4. Asynchronous Transmit Retries Register Description

BIT	FIELD NAME	TYPE	DESCRIPTION
31–29	secondLimit	R	The second limit field returns 0s when read, because outbound dual-phase retry is not implemented.
28–16	cycleLimit	R	The cycle limit field returns 0s when read, because outbound dual-phase retry is not implemented.
15–12	RSVD	R	Reserved. Bits 15–12 return 0s when read.
11–8	maxPhysRespRetries	R/W	This field tells the physical response unit how many times to attempt to retry the transmit operation for the response packet when a busy acknowledge or ack_data_error is received from the target node.
7–4	maxATRespRetries	R/W	This field tells the asynchronous transmit response unit how many times to attempt to retry the transmit operation for the response packet when a busy acknowledge or ack_data_error is received from the target node.
3–0	maxATReqRetries	R/W	This field tells the asynchronous transmit DMA request unit how many times to attempt to retry the transmit operation for the response packet when a busy acknowledge or ack_data_error is received from the target node.

4.4 CSR Data Register

The CSR data register accesses the bus management CSR registers from the host through compare-swap operations. This register contains the data to be stored in a CSR if the compare is successful.

Bit	31	30	29	28	27	26	25	24	23	22	21	20	19	18	17	16
Name	CSR data															
Type	R	R	R	R	R	R	R	R	R	R	R	R	R	R	R	R
Default	X	X	X	X	X	X	X	X	X	X	X	X	X	X	X	X
Bit	15	14	13	12	11	10	9	8	7	6	5	4	3	2	1	0
Name	CSR data															
Type	R	R	R	R	R	R	R	R	R	R	R	R	R	R	R	R
Default	X	X	X	X	X	X	X	X	X	X	X	X	X	X	X	X

Register: **CSR data**
 Offset: 0Ch
 Type: Read-only
 Default: XXXX XXXXh

4.5 CSR Compare Register

The CSR compare register accesses the bus management CSR registers from the host through compare-swap operations. This register contains the data to be compared with the existing value of the CSR resource.

Bit	31	30	29	28	27	26	25	24	23	22	21	20	19	18	17	16
Name	CSR compare															
Type	R	R	R	R	R	R	R	R	R	R	R	R	R	R	R	R
Default	X	X	X	X	X	X	X	X	X	X	X	X	X	X	X	X
Bit	15	14	13	12	11	10	9	8	7	6	5	4	3	2	1	0
Name	CSR compare															
Type	R	R	R	R	R	R	R	R	R	R	R	R	R	R	R	R
Default	X	X	X	X	X	X	X	X	X	X	X	X	X	X	X	X

Register: **CSR compare**
 Offset: 10h
 Type: Read-only
 Default: XXXX XXXXh

4.6 CSR Control Register

The CSR control register accesses the bus management CSR registers from the host through compare-swap operations. This register controls the compare-swap operation and selects the CSR resource. See Table 4–5 for a complete description of the register contents.

Bit	31	30	29	28	27	26	25	24	23	22	21	20	19	18	17	16
Name	CSR control															
Type	RU	R	R	R	R	R	R	R	R	R	R	R	R	R	R	R
Default	1	0	0	0	0	0	0	0	0	0	0	0	0	0	0	0
Bit	15	14	13	12	11	10	9	8	7	6	5	4	3	2	1	0
Name	CSR control															
Type	R	R	R	R	R	R	R	R	R	R	R	R	R	R	R/W	R/W
Default	0	0	0	0	0	0	0	0	0	0	0	0	0	0	X	X

Register: **CSR control**
 Offset: 14h
 Type: Read/Write, Read/Update, Read-only
 Default: 8000 000Xh

Table 4–5. CSR Control Register Description

BIT	FIELD NAME	TYPE	DESCRIPTION
31	csrDone	RU	Bit 31 is set to 1 by the TSB43AB21A device when a compare-swap operation is complete. It is cleared whenever this register is written.
30–2	RSVD	R	Reserved. Bits 30–2 return 0s when read.
1–0	csrSel	R/W	This field selects the CSR resource as follows: 00 = BUS_MANAGER_ID 01 = BANDWIDTH_AVAILABLE 10 = CHANNELS_AVAILABLE_HI 11 = CHANNELS_AVAILABLE_LO

4.7 Configuration ROM Header Register

The configuration ROM header register externally maps to the first quadlet of the 1394 configuration ROM, offset FFFF F000 0400h. See Table 4–6 for a complete description of the register contents.

Bit	31	30	29	28	27	26	25	24	23	22	21	20	19	18	17	16
Name	Configuration ROM header															
Type	R/W	R/W	R/W	R/W	R/W	R/W	R/W	R/W	R/W	R/W	R/W	R/W	R/W	R/W	R/W	R/W
Default	0	0	0	0	0	0	0	0	0	0	0	0	0	0	0	0
Bit	15	14	13	12	11	10	9	8	7	6	5	4	3	2	1	0
Name	Configuration ROM header															
Type	R/W	R/W	R/W	R/W	R/W	R/W	R/W	R/W	R/W	R/W	R/W	R/W	R/W	R/W	R/W	R/W
Default	X	X	X	X	X	X	X	X	X	X	X	X	X	X	X	X

Register: **Configuration ROM header**
 Offset: 18h
 Type: Read/Write
 Default: 0000 XXXXh

Table 4–6. Configuration ROM Header Register Description

BIT	FIELD NAME	TYPE	DESCRIPTION
31–24	info_length	R/W	IEEE 1394 bus-management field. Must be valid when bit 17 (linkEnable) in the host controller control register at OHCI offset 50h/54h (see Section 4.16, <i>Host Controller Control Register</i>) is set to 1.
23–16	crc_length	R/W	IEEE 1394 bus-management field. Must be valid when bit 17 (linkEnable) in the host controller control register at OHCI offset 50h/54h (see Section 4.16, <i>Host Controller Control Register</i>) is set to 1.
15–0	rom_crc_value	R/W	IEEE 1394 bus-management field. Must be valid at any time bit 17 (linkEnable) in the host controller control register at OHCI offset 50h/54h (see Section 4.16, <i>Host Controller Control Register</i>) is set to 1. The reset value is undefined if no serial EEPROM is present. If a serial EEPROM is present, this field is loaded from the serial EEPROM.

4.8 Bus Identification Register

The bus identification register externally maps to the first quadlet in the Bus_Info_Block and contains the constant 3133 3934h, which is the ASCII value of 1394.

Bit	31	30	29	28	27	26	25	24	23	22	21	20	19	18	17	16
Name	Bus identification															
Type	R	R	R	R	R	R	R	R	R	R	R	R	R	R	R	R
Default	0	0	1	1	0	0	0	1	0	0	1	1	0	0	1	1
Bit	15	14	13	12	11	10	9	8	7	6	5	4	3	2	1	0
Name	Bus identification															
Type	R	R	R	R	R	R	R	R	R	R	R	R	R	R	R	R
Default	0	0	1	1	1	0	0	1	0	0	1	1	0	1	0	0

Register: **Bus identification**
 Offset: 1Ch
 Type: Read-only
 Default: 3133 3934h

4.9 Bus Options Register

The bus options register externally maps to the second quadlet of the Bus_Info_Block. See Table 4–7 for a complete description of the register contents.

Bit	31	30	29	28	27	26	25	24	23	22	21	20	19	18	17	16
Name	Bus options															
Type	R/W	R/W	R/W	R/W	R/W	R	R	R	R/W	R/W	R/W	R/W	R/W	R/W	R/W	R/W
Default	X	X	X	X	0	0	0	0	X	X	X	X	X	X	X	X
Bit	15	14	13	12	11	10	9	8	7	6	5	4	3	2	1	0
Name	Bus options															
Type	R/W	R/W	R/W	R/W	R	R	R	R	R/W	R/W	R	R	R	R	R	R
Default	1	0	1	0	0	0	0	0	X	X	0	0	0	0	1	0

Register: **Bus options**
 Offset: 20h
 Type: Read/Write, read-only
 Default: X0XX A0X2h

Table 4–7. Bus Options Register Description

BIT	FIELD NAME	TYPE	DESCRIPTION
31	irmc	R/W	Isochronous resource-manager capable. IEEE 1394 bus-management field. Must be valid when bit 17 (linkEnable) in the host controller control register at OHCI offset 50h/54h (see Section 4.16, <i>Host Controller Control Register</i>) is set to 1.
30	cmc	R/W	Cycle master capable. IEEE 1394 bus-management field. Must be valid when bit 17 (linkEnable) in the host controller control register at OHCI offset 50h/54h (see Section 4.16, <i>Host Controller Control Register</i>) is set to 1.
29	isc	R/W	Isochronous support capable. IEEE 1394 bus-management field. Must be valid when bit 17 (linkEnable) in the host controller control register at OHCI offset 50h/54h (see Section 4.16, <i>Host Controller Control Register</i>) is set to 1.
28	bmc	R/W	Bus manager capable. IEEE 1394 bus-management field. Must be valid when bit 17 (linkEnable) in the host controller control register at OHCI offset 50h/54h (see Section 4.16, <i>Host Controller Control Register</i>) is set to 1.
27	pmc	R/W	Power-management capable. IEEE 1394 bus-management field. When bit 27 is set to 1, this indicates that the node is power-management capable. Must be valid when bit 17 (linkEnable) in the host controller control register at OHCI offset 50h/54h (see Section 4.16, <i>Host Controller Control Register</i>) is set to 1.
26–24	RSVD	R	Reserved. Bits 26–24 return 0s when read.
23–16	cyc_clk_acc	R/W	Cycle master clock accuracy, in parts per million. IEEE 1394 bus-management field. Must be valid when bit 17 (linkEnable) in the host controller control register at OHCI offset 50h/54h (see Section 4.16, <i>Host Controller Control Register</i>) is set to 1.
15–12	max_rec	R/W	Maximum request. IEEE 1394 bus-management field. Hardware initializes this field to indicate the maximum number of bytes in a block request packet that is supported by the implementation. This value, max_rec_bytes, must be 512 or greater, and is calculated by $2^{(\text{max_rec} + 1)}$. Software may change this field; however, this field must be valid at any time bit 17 (linkEnable) in the host controller control register at OHCI offset 50h/54h (see Section 4.16, <i>Host Controller Control Register</i>) is set to 1. A received block write request packet with a length greater than max_rec_bytes may generate an ack_type_error. This field is not affected by a software reset, and defaults to value indicating 2048 bytes on a system (hardware) reset.
11–8	RSVD	R	Reserved. Bits 11–8 return 0s when read.
7–6	g	R/W	Generation counter. This field is incremented if any portion of the configuration ROM has been incremented since the prior bus reset.
5–3	RSVD	R	Reserved. Bits 5–3 return 0s when read.
2–0	Lnk_spd	R	Link speed. This field returns 010, indicating that the link speeds of 100M bits/s, 200M bits/s, and 400M bits/s are supported.

4.10 GUID High Register

The GUID high register represents the upper quadlet in a 64-bit global unique ID (GUID) which maps to the third quadlet in the Bus_Info_Block. This register contains node_vendor_ID and chip_ID_hi fields. This register initializes to 0s on a system (hardware) reset, which is an illegal GUID value. If a serial EEPROM is detected, the contents of this register are loaded through the serial EEPROM interface after a $\overline{G_RST}$. At that point, the contents of this register cannot be changed. If no serial EEPROM is detected, the contents of this register are loaded by the BIOS after a $\overline{PCI_RST}$. At that point, the contents of this register cannot be changed.

Bit	31	30	29	28	27	26	25	24	23	22	21	20	19	18	17	16
Name	GUID high															
Type	R	R	R	R	R	R	R	R	R	R	R	R	R	R	R	R
Default	0	0	0	0	0	0	0	0	0	0	0	0	0	0	0	0
Bit	15	14	13	12	11	10	9	8	7	6	5	4	3	2	1	0
Name	GUID high															
Type	R	R	R	R	R	R	R	R	R	R	R	R	R	R	R	R
Default	0	0	0	0	0	0	0	0	0	0	0	0	0	0	0	0

Register: **GUID high**
 Offset: 24h
 Type: Read-only
 Default: 0000 0000h

4.11 GUID Low Register

The GUID low register represents the lower quadlet in a 64-bit global unique ID (GUID) which maps to chip_ID_lo in the Bus_Info_Block. This register initializes to 0s on a system (hardware) reset and behaves identical to the GUID high register at OHCI offset 24h (see Section 4.10, *GUID High Register*).

Bit	31	30	29	28	27	26	25	24	23	22	21	20	19	18	17	16
Name	GUID low															
Type	R	R	R	R	R	R	R	R	R	R	R	R	R	R	R	R
Default	0	0	0	0	0	0	0	0	0	0	0	0	0	0	0	0
Bit	15	14	13	12	11	10	9	8	7	6	5	4	3	2	1	0
Name	GUID low															
Type	R	R	R	R	R	R	R	R	R	R	R	R	R	R	R	R
Default	0	0	0	0	0	0	0	0	0	0	0	0	0	0	0	0

Register: **GUID low**
 Offset: 28h
 Type: Read-only
 Default: 0000 0000h

4.12 Configuration ROM Mapping Register

The configuration ROM mapping register contains the start address within system memory that maps to the start address of 1394 configuration ROM for this node. See Table 4–8 for a complete description of the register contents.

Bit	31	30	29	28	27	26	25	24	23	22	21	20	19	18	17	16
Name	Configuration ROM mapping															
Type	R/W	R/W	R/W	R/W	R/W	R/W	R/W	R/W	R/W	R/W	R/W	R/W	R/W	R/W	R/W	R/W
Default	0	0	0	0	0	0	0	0	0	0	0	0	0	0	0	0
Bit	15	14	13	12	11	10	9	8	7	6	5	4	3	2	1	0
Name	Configuration ROM mapping															
Type	R/W	R/W	R/W	R/W	R/W	R/W	R	R	R	R	R	R	R	R	R	R
Default	0	0	0	0	0	0	0	0	0	0	0	0	0	0	0	0

Register: **Configuration ROM mapping**
 Offset: 34h
 Type: Read/Write
 Default: 0000 0000h

Table 4–8. Configuration ROM Mapping Register Description

BIT	FIELD NAME	TYPE	DESCRIPTION
31–10	configROMAddr	R/W	If a quadlet read request to 1394 offset FFFF F000 0400h through offset FFFF F000 07FFh is received, the low-order 10 bits of the offset are added to this register to determine the host memory address of the read request.
9–0	RSVD	R	Reserved. Bits 9–0 return 0s when read.

4.13 Posted Write Address Low Register

The posted write address low register communicates error information if a write request is posted and an error occurs while the posted data packet is being written. See Table 4–9 for a complete description of the register contents.

Bit	31	30	29	28	27	26	25	24	23	22	21	20	19	18	17	16
Name	Posted write address low															
Type	RU	RU	RU	RU	RU	RU	RU	RU	RU	RU	RU	RU	RU	RU	RU	RU
Default	X	X	X	X	X	X	X	X	X	X	X	X	X	X	X	X
Bit	15	14	13	12	11	10	9	8	7	6	5	4	3	2	1	0
Name	Posted write address low															
Type	RU	RU	RU	RU	RU	RU	RU	RU	RU	RU	RU	RU	RU	RU	RU	RU
Default	X	X	X	X	X	X	X	X	X	X	X	X	X	X	X	X

Register: **Posted write address low**
 Offset: 38h
 Type: Read/Update
 Default: XXXX XXXXh

Table 4–9. Posted Write Address Low Register Description

BIT	FIELD NAME	TYPE	DESCRIPTION
31–0	offsetLo	RU	The lower 32 bits of the 1394 destination offset of the write request that failed.

4.14 Posted Write Address High Register

The posted write address high register communicates error information if a write request is posted and an error occurs while writing the posted data packet. See Table 4–10 for a complete description of the register contents.

Bit	31	30	29	28	27	26	25	24	23	22	21	20	19	18	17	16
Name	Posted write address high															
Type	RU	RU	RU	RU	RU	RU	RU	RU	RU	RU	RU	RU	RU	RU	RU	RU
Default	X	X	X	X	X	X	X	X	X	X	X	X	X	X	X	X
Bit	15	14	13	12	11	10	9	8	7	6	5	4	3	2	1	0
Name	Posted write address high															
Type	RU	RU	RU	RU	RU	RU	RU	RU	RU	RU	RU	RU	RU	RU	RU	RU
Default	X	X	X	X	X	X	X	X	X	X	X	X	X	X	X	X

Register: **Posted write address high**
 Offset: 3Ch
 Type: Read/Update
 Default: XXXX XXXXh

Table 4–10. Posted Write Address High Register Description

BIT	FIELD NAME	TYPE	DESCRIPTION
31–16	sourceID	RU	This field is the 10-bit bus number (bits 31–22) and 6-bit node number (bits 21–16) of the node that issued the write request that failed.
15–0	offsetHi	RU	The upper 16 bits of the 1394 destination offset of the write request that failed.

4.15 Vendor ID Register

The vendor ID register holds the company ID of an organization that specifies any vendor-unique registers. The TSB43AB21A device implements Texas Instruments unique behavior with regards to OHCI. Thus, this register is read-only and returns 0108 0028h when read.

Bit	31	30	29	28	27	26	25	24	23	22	21	20	19	18	17	16
Name	Vendor ID															
Type	R	R	R	R	R	R	R	R	R	R	R	R	R	R	R	R
Default	0	0	0	0	0	0	0	1	0	0	0	0	1	0	0	0
Bit	15	14	13	12	11	10	9	8	7	6	5	4	3	2	1	0
Name	Vendor ID															
Type	R	R	R	R	R	R	R	R	R	R	R	R	R	R	R	R
Default	0	0	0	0	0	0	0	0	0	0	1	0	1	0	0	0

Register: **Vendor ID**
 Offset: 40h
 Type: Read-only
 Default: 0108 0028h

4.16 Host Controller Control Register

The host controller control set/clear register pair provides flags for controlling the TSB43AB21A device. See Table 4–11 for a complete description of the register contents.

Bit	31	30	29	28	27	26	25	24	23	22	21	20	19	18	17	16
Name	Host controller control															
Type	RSU	RSC	RSC	R	R	R	R	R	R	RSC	R	R	RSC	RSC	RSC	RSCU
Default	0	X	0	0	0	0	0	0	1	0	0	0	0	X	0	0
Bit	15	14	13	12	11	10	9	8	7	6	5	4	3	2	1	0
Name	Host controller control															
Type	R	R	R	R	R	R	R	R	R	R	R	R	R	R	R	R
Default	0	0	0	0	0	0	0	0	0	0	0	0	0	0	0	0

Register: **Host controller control**
 Offset: 50h set register
 54h clear register
 Type: Read/Set/Clear/Update, Read/Set/Clear, Read/Clear, Read-Only
 Default: X08X 0000h

Table 4–11. Host Controller Control Register Description

BIT	FIELD NAME	TYPE	DESCRIPTION
31	BIBimage Valid	RSU	<p>When bit 31 is set to 1, the TSB43AB21A physical response unit is enabled to respond to block read requests to host configuration ROM and to the mechanism for atomically updating configuration ROM. Software creates a valid image of the bus_info_block in host configuration ROM before setting this bit.</p> <p>When this bit is cleared, the TSB43AB21A device returns ack_type_error on block read requests to host configuration ROM. Also, when this bit is cleared and a 1394 bus reset occurs, the configuration ROM mapping register at OHCI offset 34h (see Section 4.12, <i>Configuration ROM Mapping Register</i>), configuration ROM header register at OHCI offset 18h (see Section 4.7, <i>Configuration ROM Header Register</i>), and bus options register at OHCI offset 20h (see Section 4.9, <i>Bus Options Register</i>) are not updated.</p> <p>Software can set this bit only when bit 17 (linkEnable) is 0. Once bit 31 is set to 1, it can be cleared by a system (hardware) reset, a software reset, or if a fetch error occurs when the TSB43AB21A device loads bus_info_block registers from host memory.</p>
30	noByteSwapData	RSC	Bit 30 controls whether physical accesses to locations outside the TSB43AB21A device itself, as well as any other DMA data accesses are byte swapped.
29	AckTardyEnable	RSC	<p>Bit 29 controls the acknowledgement of ack_tardy. When bit 29 is set to 1, ack_tardy may be returned as an acknowledgment to accesses from the 1394 bus to the TSB43AB21A device, including accesses to the bus_info_block. The TSB43AB21A device returns ack_tardy to all other asynchronous packets addressed to the TSB43AB21A node. When the TSB43AB21A device sends ack_tardy, bit 27 (ack_tardy) in the interrupt event register at OHCI offset 80h/84h (see Section 4.21, <i>Interrupt Event Register</i>) is set to 1 to indicate the attempted asynchronous access.</p> <p>Software ensures that bit 27 (ack_tardy) in the interrupt event register is 0. Software also unmask wake-up interrupt events such as bit 19 (phy) and bit 27 (ack_tardy) in the interrupt event register before placing the TSB43AB21A device into the D1 power mode.</p> <p>Software must not set this bit if the TSB43AB21A node is the 1394 bus manager.</p>
28–24	RSVD	R	Reserved. Bits 28–24 return 0s when read.
23	programPhyEnable	R	Bit 23 informs upper-level software that lower-level software has consistently configured the IEEE 1394a-2000 enhancements in the link and PHY layers. When this bit is 1, generic software such as the OHCI driver is responsible for configuring IEEE 1394a-2000 enhancements in the PHY layer and bit 22 (aPhyEnhanceEnable). When this bit is 0, the generic software may not modify the IEEE 1394a-2000 enhancements in the PHY layer and cannot interpret the setting of bit 22 (aPhyEnhanceEnable). This bit is initialized from serial EEPROM. This bit defaults to 1.

Table 4–11. Host Controller Control Register Description (Continued)

BIT	FIELD NAME	TYPE	DESCRIPTION
22	aPhyEnhanceEnable	RSC	When bits 23 (programPhyEnable) and 17 (linkEnable) are 1, the OHCI driver can set bit 22 to 1 to use all IEEE 1394a-2000 enhancements. When bit 23 (programPhyEnable) is cleared to 0, the software does not change PHY enhancements or this bit.
21–20	RSVD	R	Reserved. Bits 21 and 20 return 0s when read.
19	LPS	RSC	Bit 19 controls the link power status. Software must set this bit to 1 to permit the link-PHY communication. A 0 prevents link-PHY communication. The OHCI-link is divided into two clock domains (PCI_CLK and PHY_SCLK). If software tries to access any register in the PHY_SCLK domain while the PHY_SCLK is disabled, a target abort is issued by the link. This problem can be avoided by setting bit 4 (DIS_TGT_ABT) to 1 in the miscellaneous configuration register at offset F0h in the PCI configuration space (see Section 3.23, <i>Miscellaneous Configuration Register</i>). This allows the link to respond to these types of request by returning all Fs (hex). OHCI registers at offsets DCh–F0h and 100h–11Ch are in the PHY_SCLK domain. After setting LPS, software must wait approximately 10 ms before attempting to access any of the OHCI registers. This gives the PHY_SCLK time to stabilize.
18	postedWriteEnable	RSC	Bit 18 enables (1) or disables (0) posted writes. Software changes this bit only when bit 17 (linkEnable) is 0.
17	linkEnable	RSC	Bit 17 is cleared to 0 by either a system (hardware) or software reset. Software must set this bit to 1 when the system is ready to begin operation and then force a bus reset. This bit is necessary to keep other nodes from sending transactions before the local system is ready. When this bit is cleared, the TSB43AB21A device is logically and immediately disconnected from the 1394 bus, no packets are received or processed, nor are packets transmitted.
16	SoftReset	RSCU	When bit 16 is set to 1, all TSB43AB21A states are reset, all FIFOs are flushed, and all OHCI registers are set to their system (hardware) reset values, unless otherwise specified. PCI registers are not affected by this bit. This bit remains set to 1 while the software reset is in progress and reverts back to 0 when the reset has completed.
15–0	RSVD	R	Reserved. Bits 15–0 return 0s when read.

4.17 Self-ID Buffer Pointer Register

The self-ID buffer pointer register points to the 2K-byte aligned base address of the buffer in host memory where the self-ID packets are stored during bus initialization. Bits 31–11 are read/write accessible. Bits 10–0 are reserved, and return 0s when read.

Bit	31	30	29	28	27	26	25	24	23	22	21	20	19	18	17	16
Name	Self-ID buffer pointer															
Type	R/W	R/W	R/W	R/W	R/W	R/W	R/W	R/W	R/W	R/W	R/W	R/W	R/W	R/W	R/W	R/W
Default	X	X	X	X	X	X	X	X	X	X	X	X	X	X	X	X
Bit	15	14	13	12	11	10	9	8	7	6	5	4	3	2	1	0
Name	Self-ID buffer pointer															
Type	R/W	R/W	R/W	R/W	R/W	R	R	R	R	R	R	R	R	R	R	R
Default	X	X	X	X	X	0	0	0	0	0	0	0	0	0	0	0

Register: **Self-ID buffer pointer**
 Offset: 64h
 Type: Read/Write, Read-Only
 Default: XXXX XX00h

4.18 Self-ID Count Register

The self-ID count register keeps a count of the number of times the bus self-ID process has occurred, flags self-ID packet errors, and keeps a count of the self-ID data in the self-ID buffer. See Table 4–12 for a complete description of the register contents.

Bit	31	30	29	28	27	26	25	24	23	22	21	20	19	18	17	16
Name	Self-ID count															
Type	RU	R	R	R	R	R	R	R	RU	RU	RU	RU	RU	RU	RU	RU
Default	X	0	0	0	0	0	0	0	X	X	X	X	X	X	X	X
Bit	15	14	13	12	11	10	9	8	7	6	5	4	3	2	1	0
Name	Self-ID count															
Type	R	R	R	R	R	RU	RU	RU	RU	RU	RU	RU	RU	RU	R	R
Default	0	0	0	0	0	0	0	0	0	0	0	0	0	0	0	0

Register: **Self-ID count**
 Offset: 68h
 Type: Read/Update, Read-Only
 Default: X0XX 0000h

Table 4–12. Self-ID Count Register Description

BIT	FIELD NAME	TYPE	DESCRIPTION
31	selfIDError	RU	When bit 31 is set to 1, an error was detected during the most recent self-ID packet reception. The contents of the self-ID buffer are undefined. This bit is cleared after a self-ID reception in which no errors are detected. Note that an error can be a hardware error or a host bus write error.
30–24	RSVD	R	Reserved. Bits 30–24 return 0s when read.
23–16	selfIDGeneration	RU	The value in this field increments each time a bus reset is detected. This field rolls over to 0 after reaching 255.
15–11	RSVD	R	Reserved. Bits 15–11 return 0s when read.
10–2	selfIDSize	RU	This field indicates the number of quadlets that have been written into the self-ID buffer for the current bits 23–16 (selfIDGeneration field). This includes the header quadlet and the self-ID data. This field is cleared to 0s when the self-ID reception begins.
1–0	RSVD	R	Reserved. Bits 1 and 0 return 0s when read.

4.19 Isochronous Receive Channel Mask High Register

The isochronous receive channel mask high set/clear register enables packet receives from the upper 32 isochronous data channels. A read from either the set register or clear register returns the content of the isochronous receive channel mask high register. See Table 4–13 for a complete description of the register contents.

Bit	31	30	29	28	27	26	25	24	23	22	21	20	19	18	17	16
Name	Isochronous receive channel mask high															
Type	RSC	RSC	RSC	RSC	RSC	RSC	RSC	RSC	RSC	RSC	RSC	RSC	RSC	RSC	RSC	RSC
Default	X	X	X	X	X	X	X	X	X	X	X	X	X	X	X	X
Bit	15	14	13	12	11	10	9	8	7	6	5	4	3	2	1	0
Name	Isochronous receive channel mask high															
Type	RSC	RSC	RSC	RSC	RSC	RSC	RSC	RSC	RSC	RSC	RSC	RSC	RSC	RSC	RSC	RSC
Default	X	X	X	X	X	X	X	X	X	X	X	X	X	X	X	X

Register: **Isochronous receive channel mask high**

Offset: 70h set register
74h clear register

Type: Read/Set/Clear

Default: XXXX XXXXh

Table 4–13. Isochronous Receive Channel Mask High Register Description

BIT	FIELD NAME	TYPE	DESCRIPTION
31	isoChannel63	RSC	When bit 31 is set to 1, the TSB43AB21A device is enabled to receive from isochronous channel number 63.
30	isoChannel62	RSC	When bit 30 is set to 1, the TSB43AB21A device is enabled to receive from isochronous channel number 62.
29	isoChannel61	RSC	When bit 29 is set to 1, the TSB43AB21A device is enabled to receive from isochronous channel number 61.
28	isoChannel60	RSC	When bit 28 is set to 1, the TSB43AB21A device is enabled to receive from isochronous channel number 60.
27	isoChannel59	RSC	When bit 27 is set to 1, the TSB43AB21A device is enabled to receive from isochronous channel number 59.
26	isoChannel58	RSC	When bit 26 is set to 1, the TSB43AB21A device is enabled to receive from isochronous channel number 58.
25	isoChannel57	RSC	When bit 25 is set to 1, the TSB43AB21A device is enabled to receive from isochronous channel number 57.
24	isoChannel56	RSC	When bit 24 is set to 1, the TSB43AB21A device is enabled to receive from isochronous channel number 56.
23	isoChannel55	RSC	When bit 23 is set to 1, the TSB43AB21A device is enabled to receive from isochronous channel number 55.
22	isoChannel54	RSC	When bit 22 is set to 1, the TSB43AB21A device is enabled to receive from isochronous channel number 54.
21	isoChannel53	RSC	When bit 21 is set to 1, the TSB43AB21A device is enabled to receive from isochronous channel number 53.
20	isoChannel52	RSC	When bit 20 is set to 1, the TSB43AB21A device is enabled to receive from isochronous channel number 52.
19	isoChannel51	RSC	When bit 19 is set to 1, the TSB43AB21A device is enabled to receive from isochronous channel number 51.
18	isoChannel50	RSC	When bit 18 is set to 1, the TSB43AB21A device is enabled to receive from isochronous channel number 50.
17	isoChannel49	RSC	When bit 17 is set to 1, the TSB43AB21A device is enabled to receive from isochronous channel number 49.
16	isoChannel48	RSC	When bit 16 is set to 1, the TSB43AB21A device is enabled to receive from isochronous channel number 48.
15	isoChannel47	RSC	When bit 15 is set to 1, the TSB43AB21A device is enabled to receive from isochronous channel number 47.
14	isoChannel46	RSC	When bit 14 is set to 1, the TSB43AB21A device is enabled to receive from isochronous channel number 46.
13	isoChannel45	RSC	When bit 13 is set to 1, the TSB43AB21A device is enabled to receive from isochronous channel number 45.
12	isoChannel44	RSC	When bit 12 is set to 1, the TSB43AB21A device is enabled to receive from isochronous channel number 44.
11	isoChannel43	RSC	When bit 11 is set to 1, the TSB43AB21A device is enabled to receive from isochronous channel number 43.
10	isoChannel42	RSC	When bit 10 is set to 1, the TSB43AB21A device is enabled to receive from isochronous channel number 42.
9	isoChannel41	RSC	When bit 9 is set to 1, the TSB43AB21A device is enabled to receive from isochronous channel number 41.
8	isoChannel40	RSC	When bit 8 is set to 1, the TSB43AB21A device is enabled to receive from isochronous channel number 40.
7	isoChannel39	RSC	When bit 7 is set to 1, the TSB43AB21A device is enabled to receive from isochronous channel number 39.

Table 4–13. Isochronous Receive Channel Mask High Register Description (Continued)

BIT	FIELD NAME	TYPE	DESCRIPTION
6	isoChannel38	RSC	When bit 6 is set to 1, the TSB43AB21A device is enabled to receive from isochronous channel number 38.
5	isoChannel37	RSC	When bit 5 is set to 1, the TSB43AB21A device is enabled to receive from isochronous channel number 37.
4	isoChannel36	RSC	When bit 4 is set to 1, the TSB43AB21A device is enabled to receive from isochronous channel number 36.
3	isoChannel35	RSC	When bit 3 is set to 1, the TSB43AB21A device is enabled to receive from isochronous channel number 35.
2	isoChannel34	RSC	When bit 2 is set to 1, the TSB43AB21A device is enabled to receive from isochronous channel number 34.
1	isoChannel33	RSC	When bit 1 is set to 1, the TSB43AB21A device is enabled to receive from isochronous channel number 33.
0	isoChannel32	RSC	When bit 0 is set to 1, the TSB43AB21A device is enabled to receive from isochronous channel number 32.

4.20 Isochronous Receive Channel Mask Low Register

The isochronous receive channel mask low set/clear register enables packet receives from the lower 32 isochronous data channels. See Table 4–14 for a complete description of the register contents.

Bit	31	30	29	28	27	26	25	24	23	22	21	20	19	18	17	16
Name	Isochronous receive channel mask low															
Type	RSC	RSC	RSC	RSC	RSC	RSC	RSC	RSC	RSC	RSC	RSC	RSC	RSC	RSC	RSC	RSC
Default	X	X	X	X	X	X	X	X	X	X	X	X	X	X	X	X
Bit	15	14	13	12	11	10	9	8	7	6	5	4	3	2	1	0
Name	Isochronous receive channel mask low															
Type	RSC	RSC	RSC	RSC	RSC	RSC	RSC	RSC	RSC	RSC	RSC	RSC	RSC	RSC	RSC	RSC
Default	X	X	X	X	X	X	X	X	X	X	X	X	X	X	X	X

Register: **Isochronous receive channel mask low**
 Offset: 78h set register
 7Ch clear register
 Type: Read/Set/Clear
 Default: XXXX XXXXh

Table 4–14. Isochronous Receive Channel Mask Low Register Description

BIT	FIELD NAME	TYPE	DESCRIPTION
31	isoChannel31	RSC	When bit 31 is set to 1, the TSB43AB21A device is enabled to receive from isochronous channel number 31.
30	isoChannel30	RSC	When bit 30 is set to 1, the TSB43AB21A device is enabled to receive from isochronous channel number 30.
29–2	isoChanneln	RSC	Bits 29 through 2 (isoChanneln, where n = 29, 28, 27, ..., 2) follow the same pattern as bits 31 and 30.
1	isoChannel1	RSC	When bit 1 is set to 1, the TSB43AB21A device is enabled to receive from isochronous channel number 1.
0	isoChannel0	RSC	When bit 0 is set to 1, the TSB43AB21A device is enabled to receive from isochronous channel number 0.

4.21 Interrupt Event Register

The interrupt event set/clear register reflects the state of the various TSB43AB21A interrupt sources. The interrupt bits are set to 1 by an asserting edge of the corresponding interrupt signal or by writing a 1 in the corresponding bit in the set register. The only mechanism to clear a bit in this register is to write a 1 to the corresponding bit in the clear register.

This register is fully compliant with the *1394 Open Host Controller Interface Specification*, and the TSB43AB21A device adds a vendor-specific interrupt function to bit 30. When the interrupt event register is read, the return value is the bit-wise AND function of the interrupt event and interrupt mask registers. See Table 4–15 for a complete description of the register contents.

Bit	31	30	29	28	27	26	25	24	23	22	21	20	19	18	17	16
Name	Interrupt event															
Type	R	RSC	RSC	R	RSCU	RSCU	RSCU	RSCU	RSCU	RSCU	RSCU	RSCU	RSCU	RSCU	RSCU	RSCU
Default	0	X	0	0	0	X	X	X	X	X	X	X	X	0	X	X
Bit	15	14	13	12	11	10	9	8	7	6	5	4	3	2	1	0
Name	Interrupt event															
Type	RSCU	R	R	R	R	R	RSCU	RSCU	RU	RU	RSCU	RSCU	RSCU	RSCU	RSCU	RSCU
Default	0	0	0	0	0	0	X	X	X	X	X	X	X	X	X	X

Register: **Interrupt event**

Offset: 80h set register

84h clear register [returns the content of the interrupt event register bit-wise ANDed with the interrupt mask register when read]

Type: Read/Set/Clear/Update, Read/Set/Clear, Read/Update, Read-Only

Default: XXXX 0XXXh

Table 4–15. Interrupt Event Register Description

BIT	FIELD NAME	TYPE	DESCRIPTION
31	RSVD	R	Reserved. Bit 31 returns 0 when read.
30	vendorSpecific	RSC	This vendor-specific interrupt event is reported when either of the general-purpose interrupts are asserted. The general-purpose interrupts are enabled by setting the corresponding bits INT_3EN and INT_2EN (bits 31 and 23, respectively) to 1 in the GPIO control register at offset FCh in the PCI configuration space (see Section 3.26, <i>GPIO Control Register</i>).
29	SoftInterrupt	RSC	Bit 29 is used by software to generate a TSB43AB21A interrupt for its own use.
28	RSVD	R	Reserved. Bit 28 returns 0 when read.
27	ack_tardy	RSCU	Bit 27 is set to 1 when bit 29 (AckTardyEnable) in the host controller control register at OHCI offset 50h/54h (see Section 4.16, <i>Host Controller Control Register</i>) is set to 1 and any of the following conditions occur: <ul style="list-style-type: none"> a. Data is present in a receive FIFO that is to be delivered to the host. b. The physical response unit is busy processing requests or sending responses. c. The TSB43AB21A device sent an ack_tardy acknowledgment.
26	phyRegRcvd	RSCU	The TSB43AB21A device has received a PHY register data byte which can be read from bits 23–16 in the PHY layer control register at OHCI offset ECh (see Section 4.33, <i>PHY Layer Control Register</i>).
25	cycleTooLong	RSCU	If bit 21 (cycleMaster) in the link control register at OHCI offset E0h/E4h (see Section 4.31, <i>Link Control Register</i>) is set to 1, this indicates that over 125 μs has elapsed between the start of sending a cycle start packet and the end of a subaction gap. Bit 21 (cycleMaster) in the link control register is cleared by this event.
24	unrecoverableError	RSCU	This event occurs when the TSB43AB21A device encounters any error that forces it to stop operations on any or all of its subunits, for example, when a DMA context sets its dead bit to 1. While bit 24 is set to 1, all normal interrupts for the context(s) that caused this interrupt are blocked from being set to 1.

Table 4–15. Interrupt Event Register Description (Continued)

BIT	FIELD NAME	TYPE	DESCRIPTION
23	cycleInconsistent	RSCU	A cycle start was received that had values for the cycleSeconds and cycleCount fields that are different from the values in bits 31–25 (cycleSeconds field) and bits 24–12 (cycleCount field) in the isochronous cycle timer register at OHCI offset F0h (see Section 4.34, <i>Isochronous Cycle Timer Register</i>).
22	cycleLost	RSCU	A lost cycle is indicated when no cycle_start packet is sent or received between two successive cycleSynch events. A lost cycle can be predicted when a cycle_start packet does not immediately follow the first subaction gap after the cycleSynch event or if an arbitration reset gap is detected after a cycleSynch event without an intervening cycle start. Bit 22 may be set to 1 either when a lost cycle occurs or when logic predicts that one will occur.
21	cycle64Seconds	RSCU	Indicates that the 7 th bit of the cycle second counter has changed.
20	cycleSynch	RSCU	Indicates that a new isochronous cycle has started. Bit 20 is set to 1 when the low-order bit of the cycle count toggles.
19	phy	RSCU	Indicates that the PHY layer requests an interrupt through a status transfer.
18	regAccessFail	RSCU	Indicates that a TSB43AB21A register access has failed due to a missing SCLK clock signal from the PHY layer. When a register access fails, bit 18 is set to 1 before the next register access.
17	busReset	RSCU	Indicates that the PHY layer has entered bus reset mode.
16	selfIDcomplete	RSCU	A self-ID packet stream has been received. It is generated at the end of the bus initialization process. Bit 16 is turned off simultaneously when bit 17 (busReset) is turned on.
15	selfIDcomplete2	RSCU	Secondary indication of the end of a self-ID packet stream. Bit 15 is set to 1 by the TSB43AB21A device when it sets bit 16 (selfIDcomplete), and retains the state, independent of bit 17 (busReset).
14–10	RSVD	R	Reserved. Bits 14–10 return 0s when read.
9	lockRespErr	RSCU	Indicates that the TSB43AB21A device sent a lock response for a lock request to a serial bus register, but did not receive an ack_complete.
8	postedWriteErr	RSCU	Indicates that a host bus error occurred while the TSB43AB21A device was trying to write a 1394 write request, which had already been given an ack_complete, into system memory.
7	isochRx	RU	Isochronous receive DMA interrupt. Indicates that one or more isochronous receive contexts have generated an interrupt. This is not a latched event; it is the logical OR of all bits in the isochronous receive interrupt event register at OHCI offset A0h/A4h (see Section 4.25, <i>Isochronous Receive Interrupt Event Register</i>) and isochronous receive interrupt mask register at OHCI offset A8h/ACh (see Section 4.26, <i>Isochronous Receive Interrupt Mask Register</i>). The isochronous receive interrupt event register indicates which contexts have been interrupted.
6	isochTx	RU	Isochronous transmit DMA interrupt. Indicates that one or more isochronous transmit contexts have generated an interrupt. This is not a latched event; it is the logical OR of all bits in the isochronous transmit interrupt event register at OHCI offset 90h/94h (see Section 4.23, <i>Isochronous Transmit Interrupt Event Register</i>) and isochronous transmit interrupt mask register at OHCI offset 98h/9Ch (see Section 4.24, <i>Isochronous Transmit Interrupt Mask Register</i>). The isochronous transmit interrupt event register indicates which contexts have been interrupted.
5	RSPkt	RSCU	Indicates that a packet was sent to an asynchronous receive response context buffer and the descriptor xferStatus and resCount fields have been updated.
4	RQPkt	RSCU	Indicates that a packet was sent to an asynchronous receive request context buffer and the descriptor xferStatus and resCount fields have been updated.
3	ARRS	RSCU	Asynchronous receive response DMA interrupt. Bit 3 is conditionally set to 1 upon completion of an ARRS DMA context command descriptor.
2	ARRQ	RSCU	Asynchronous receive request DMA interrupt. Bit 2 is conditionally set to 1 upon completion of an ARRQ DMA context command descriptor.
1	respTxComplete	RSCU	Asynchronous response transmit DMA interrupt. Bit 1 is conditionally set to 1 upon completion of an ATRS DMA command.
0	reqTxComplete	RSCU	Asynchronous request transmit DMA interrupt. Bit 0 is conditionally set to 1 upon completion of an ATRQ DMA command.

4.22 Interrupt Mask Register

The interrupt mask set/clear register enables the various TSB43AB21A interrupt sources. Reads from either the set register or the clear register always return the contents of the interrupt mask register. In all cases except masterIntEnable (bit 31) and vendorSpecific (bit 30), the enables for each interrupt event align with the interrupt event register bits detailed in Table 4–15.

This register is fully compliant with the *1394 Open Host Controller Interface Specification* and the TSB43AB21A device adds an interrupt function to bit 30. See Table 4–16 for a complete description of bits 31 and 30.

Bit	31	30	29	28	27	26	25	24	23	22	21	20	19	18	17	16
Name	Interrupt mask															
Type	RSCU	RSC	RSC	R	RSC	RSC	RSC	RSC	RSC	RSC	RSC	RSC	RSC	RSC	RSC	RSC
Default	X	X	0	0	0	X	X	X	X	X	X	X	X	0	X	X
Bit	15	14	13	12	11	10	9	8	7	6	5	4	3	2	1	0
Name	Interrupt mask															
Type	RSC	R	R	R	R	R	RSC	RSC	RSC	RSC	RSC	RSC	RSC	RSC	RSC	RSC
Default	0	0	0	0	0	0	X	X	X	X	X	X	X	X	X	X

Register: **Interrupt mask**
 Offset: 88h set register
 8Ch clear register
 Type: Read/Set/Clear/Update, Read/Set/Clear, Read/Update, Read-Only
 Default: XXXX 0XXXh

Table 4–16. Interrupt Mask Register Description

BIT	FIELD NAME	TYPE	DESCRIPTION
31	masterIntEnable	RSCU	Master interrupt enable. If bit 31 is set to 1, external interrupts are generated in accordance with the interrupt mask register. If this bit is cleared, external interrupts are not generated regardless of the interrupt mask register settings.
30	VendorSpecific	RSC	When this bit and bit 30 (vendorSpecific) in the interrupt event register at OHCI offset 80h/84h (see Section 4.21, <i>Interrupt Event Register</i>) are set to 1, this vendor-specific interrupt mask enables interrupt generation.
29	SoftInterrupt	RSC	When this bit and bit 29 (SoftInterrupt) in the interrupt event register at OHCI offset 80h/84h (see Section 4.21, <i>Interrupt Event Register</i>) are set to 1, this soft-interrupt mask enables interrupt generation.
28	RSVD	R	Reserved. Bit 28 returns 0 when read.
27	ack_tardy	RSC	When this bit and bit 27 (ack_tardy) in the interrupt event register at OHCI offset 80h/84h (see Section 4.21, <i>Interrupt Event Register</i>) are set to 1, this acknowledge-tardy interrupt mask enables interrupt generation.
26	phyRegRcvd	RSC	When this bit and bit 26 (phyRegRcvd) in the interrupt event register at OHCI offset 80h/84h (see Section 4.21, <i>Interrupt Event Register</i>) are set to 1, this PHY-register interrupt mask enables interrupt generation.
25	cycleTooLong	RSC	When this bit and bit 25 (cycleTooLong) in the interrupt event register at OHCI offset 80h/84h (see Section 4.21, <i>Interrupt Event Register</i>) are set to 1, this cycle-too-long interrupt mask enables interrupt generation.
24	unrecoverableError	RSC	When this bit and bit 24 (unrecoverableError) in the interrupt event register at OHCI offset 80h/84h (see Section 4.21, <i>Interrupt Event Register</i>) are set to 1, this unrecoverable-error interrupt mask enables interrupt generation.
23	cycleInconsistent	RSC	When this bit and bit 23 (cycleInconsistent) in the interrupt event register at OHCI offset 80h/84h (see Section 4.21, <i>Interrupt Event Register</i>) are set to 1, this inconsistent-cycle interrupt mask enables interrupt generation.
22	cycleLost	RSC	When this bit and bit 22 (cycleLost) in the interrupt event register at OHCI offset 80h/84h (see Section 4.21, <i>Interrupt Event Register</i>) are set to 1, this lost-cycle interrupt mask enables interrupt generation.

Table 4–16. Interrupt Mask Register Description (Continued)

BIT	FIELD NAME	TYPE	DESCRIPTION
21	cycle64Seconds	RSC	When this bit and bit 21 (cycle64Seconds) in the interrupt event register at OHCI offset 80h/84h (see Section 4.21, <i>Interrupt Event Register</i>) are set to 1, this 64-second-cycle interrupt mask enables interrupt generation.
20	cycleSynch	RSC	When this bit and bit 20 (cycleSynch) in the interrupt event register at OHCI offset 80h/84h (see Section 4.21, <i>Interrupt Event Register</i>) are set to 1, this isochronous-cycle interrupt mask enables interrupt generation.
19	phy	RSC	When this bit and bit 19 (phy) in the interrupt event register at OHCI offset 80h/84h (see Section 4.21, <i>Interrupt Event Register</i>) are set to 1, this PHY-status-transfer interrupt mask enables interrupt generation.
18	regAccessFail	RSC	When this bit and bit 18 (regAccessFail) in the interrupt event register at OHCI offset 80h/84h (see Section 4.21, <i>Interrupt Event Register</i>) are set to 1, this register-access-failed interrupt mask enables interrupt generation.
17	busReset	RSC	When this bit and bit 17 (busReset) in the interrupt event register at OHCI offset 80h/84h (see Section 4.21, <i>Interrupt Event Register</i>) are set to 1, this bus-reset interrupt mask enables interrupt generation.
16	selfIDcomplete	RSC	When this bit and bit 16 (selfIDcomplete) in the interrupt event register at OHCI offset 80h/84h (see Section 4.21, <i>Interrupt Event Register</i>) are set to 1, this self-ID-complete interrupt mask enables interrupt generation.
15	selfIDcomplete2	RSC	When this bit and bit 15 (selfIDcomplete2) in the interrupt event register at OHCI offset 80h/84h (see Section 4.21, <i>Interrupt Event Register</i>) are set to 1, this second-self-ID-complete interrupt mask enables interrupt generation.
14–10	RSVD	R	Reserved. Bits 14–10 return 0s when read.
9	lockRespErr	RSC	When this bit and bit 9 (lockRespErr) in the interrupt event register at OHCI offset 80h/84h (see Section 4.21, <i>Interrupt Event Register</i>) are set to 1, this lock-response-error interrupt mask enables interrupt generation.
8	postedWriteErr	RSC	When this bit and bit 8 (postedWriteErr) in the interrupt event register at OHCI offset 80h/84h (see Section 4.21, <i>Interrupt Event Register</i>) are set to 1, this posted-write-error interrupt mask enables interrupt generation.
7	isochRx	RSC	When this bit and bit 7 (isochRx) in the interrupt event register at OHCI offset 80h/84h (see Section 4.21, <i>Interrupt Event Register</i>) are set to 1, this isochronous-receive-DMA interrupt mask enables interrupt generation.
6	isochTx	RSC	When this bit and bit 6 (isochTx) in the interrupt event register at OHCI offset 80h/84h (see Section 4.21, <i>Interrupt Event Register</i>) are set to 1, this isochronous-transmit-DMA interrupt mask enables interrupt generation.
5	RSPkt	RSC	When this bit and bit 5 (RSPkt) in the interrupt event register at OHCI offset 80h/84h (see Section 4.21, <i>Interrupt Event Register</i>) are set to 1, this receive-response-packet interrupt mask enables interrupt generation.
4	RQPkt	RSC	When this bit and bit 4 (RQPkt) in the interrupt event register at OHCI offset 80h/84h (see Section 4.21, <i>Interrupt Event Register</i>) are set to 1, this receive-request-packet interrupt mask enables interrupt generation.
3	ARRS	RSC	When this bit and bit 3 (ARRS) in the interrupt event register at OHCI offset 80h/84h (see Section 4.21, <i>Interrupt Event Register</i>) are set to 1, this asynchronous-receive-response-DMA interrupt mask enables interrupt generation.
2	ARRQ	RSC	When this bit and bit 2 (ARRQ) in the interrupt event register at OHCI offset 80h/84h (see Section 4.21, <i>Interrupt Event Register</i>) are set to 1, this asynchronous-receive-request-DMA interrupt mask enables interrupt generation.
1	respTxComplete	RSC	When this bit and bit 1 (respTxComplete) in the interrupt event register at OHCI offset 80h/84h (see Section 4.21, <i>Interrupt Event Register</i>) are set to 1, this response-transmit-complete interrupt mask enables interrupt generation.
0	reqTxComplete	RSC	When this bit and bit 0 (reqTxComplete) in the interrupt event register at OHCI offset 80h/84h (see Section 4.21, <i>Interrupt Event Register</i>) are set to 1, this request-transmit-complete interrupt mask enables interrupt generation.

4.23 Isochronous Transmit Interrupt Event Register

The isochronous transmit interrupt event set/clear register reflects the interrupt state of the isochronous transmit contexts. An interrupt is generated on behalf of an isochronous transmit context if an OUTPUT_LAST* command completes and its interrupt bits are set to 1. Upon determining that the isochTx (bit 6) interrupt has occurred in the interrupt event register at OHCI offset 80h/84h (see Section 4.21, *Interrupt Event Register*), software can check this register to determine which context(s) caused the interrupt. The interrupt bits are set to 1 by an asserting edge of the corresponding interrupt signal, or by writing a 1 in the corresponding bit in the set register. The only mechanism to clear a bit in this register is to write a 1 to the corresponding bit in the clear register. See Table 4–17 for a complete description of the register contents.

Bit	31	30	29	28	27	26	25	24	23	22	21	20	19	18	17	16
Name	Isochronous transmit interrupt event															
Type	R	R	R	R	R	R	R	R	R	R	R	R	R	R	R	R
Default	0	0	0	0	0	0	0	0	0	0	0	0	0	0	0	0
Bit	15	14	13	12	11	10	9	8	7	6	5	4	3	2	1	0
Name	Isochronous transmit interrupt event															
Type	R	R	R	R	R	R	R	R	RSC	RSC	RSC	RSC	RSC	RSC	RSC	RSC
Default	0	0	0	0	0	0	0	0	X	X	X	X	X	X	X	X

Register: **Isochronous transmit interrupt event**
 Offset: 90h set register
 94h clear register [returns the contents of the isochronous transmit interrupt event register bit-wise ANDed with the isochronous transmit interrupt mask register when read]
 Type: Read/Set/Clear, Read-Only
 Default: 0000 00XXh

Table 4–17. Isochronous Transmit Interrupt Event Register Description

BIT	FIELD NAME	TYPE	DESCRIPTION
31–8	RSVD	R	Reserved. Bits 31–8 return 0s when read.
7	isoXmit7	RSC	Isochronous transmit channel 7 caused the interrupt event register bit 6 (isochTx) interrupt.
6	isoXmit6	RSC	Isochronous transmit channel 6 caused the interrupt event register bit 6 (isochTx) interrupt.
5	isoXmit5	RSC	Isochronous transmit channel 5 caused the interrupt event register bit 6 (isochTx) interrupt.
4	isoXmit4	RSC	Isochronous transmit channel 4 caused the interrupt event register bit 6 (isochTx) interrupt.
3	isoXmit3	RSC	Isochronous transmit channel 3 caused the interrupt event register bit 6 (isochTx) interrupt.
2	isoXmit2	RSC	Isochronous transmit channel 2 caused the interrupt event register bit 6 (isochTx) interrupt.
1	isoXmit1	RSC	Isochronous transmit channel 1 caused the interrupt event register bit 6 (isochTx) interrupt.
0	isoXmit0	RSC	Isochronous transmit channel 0 caused the interrupt event register bit 6 (isochTx) interrupt.

4.24 Isochronous Transmit Interrupt Mask Register

The isochronous transmit interrupt mask set/clear register enables the isochTx interrupt source on a per-channel basis. Reads from either the set register or the clear register always return the contents of the isochronous transmit interrupt mask register. In all cases the enables for each interrupt event align with the isochronous transmit interrupt event register bits detailed in Table 4–17.

Bit	31	30	29	28	27	26	25	24	23	22	21	20	19	18	17	16
Name	Isochronous transmit interrupt mask															
Type	R	R	R	R	R	R	R	R	R	R	R	R	R	R	R	R
Default	0	0	0	0	0	0	0	0	0	0	0	0	0	0	0	0
Bit	15	14	13	12	11	10	9	8	7	6	5	4	3	2	1	0
Name	Isochronous transmit interrupt mask															
Type	R	R	R	R	R	R	R	R	RSC	RSC	RSC	RSC	RSC	RSC	RSC	RSC
Default	0	0	0	0	0	0	0	0	X	X	X	X	X	X	X	X

Register: **Isochronous transmit interrupt mask**

Offset: 98h set register
9Ch clear register

Type: Read/Set/Clear, Read-Only

Default: 0000 00XXh

4.25 Isochronous Receive Interrupt Event Register

The isochronous receive interrupt event set/clear register reflects the interrupt state of the isochronous receive contexts. An interrupt is generated on behalf of an isochronous receive context if an INPUT_* command completes and its interrupt bits are set to 1. Upon determining that the isochRx (bit 7) interrupt in the interrupt event register at OHCI offset 80h/84h (see Section 4.21, *Interrupt Event Register*) has occurred, software can check this register to determine which context(s) caused the interrupt. The interrupt bits are set to 1 by an asserting edge of the corresponding interrupt signal or by writing a 1 in the corresponding bit in the set register. The only mechanism to clear a bit in this register is to write a 1 to the corresponding bit in the clear register. See Table 4–18 for a complete description of the register contents.

Bit	31	30	29	28	27	26	25	24	23	22	21	20	19	18	17	16	
Name	Isochronous receive interrupt event																
Type	R	R	R	R	R	R	R	R	R	R	R	R	R	R	R	R	
Default	0	0	0	0	0	0	0	0	0	0	0	0	0	0	0	0	
Bit	15	14	13	12	11	10	9	8	7	6	5	4	3	2	1	0	
Name	Isochronous receive interrupt event																
Type	R	R	R	R	R	R	R	R	R	R	R	R	R	RSC	RSC	RSC	RSC
Default	0	0	0	0	0	0	0	0	0	0	0	0	0	X	X	X	X

Register: **Isochronous receive interrupt event**

Offset: A0h set register
A4h clear register [returns the contents of isochronous receive interrupt event register bit-wise ANDed with the isochronous receive mask register when read]

Type: Read/Set/Clear, read-only

Default: 0000 000Xh

Table 4–18. Isochronous Receive Interrupt Event Register Description

BIT	FIELD NAME	TYPE	DESCRIPTION
31–4	RSVD	R	Reserved. Bits 31–4 return 0s when read.
3	isoRecv3	RSC	Isochronous receive channel 3 caused the interrupt event register bit 7 (isochRx) interrupt.
2	isoRecv2	RSC	Isochronous receive channel 2 caused the interrupt event register bit 7 (isochRx) interrupt.
1	isoRecv1	RSC	Isochronous receive channel 1 caused the interrupt event register bit 7 (isochRx) interrupt.
0	isoRecv0	RSC	Isochronous receive channel 0 caused the interrupt event register bit 7 (isochRx) interrupt.

4.26 Isochronous Receive Interrupt Mask Register

The isochronous receive interrupt mask set/clear register enables the isochRx interrupt source on a per-channel basis. Reads from either the set register or the clear register always return the contents of the isochronous receive interrupt mask register. In all cases the enables for each interrupt event align with the isochronous receive interrupt event register bits detailed in Table 4–18.

Bit	31	30	29	28	27	26	25	24	23	22	21	20	19	18	17	16	
Name	Isochronous receive interrupt mask																
Type	R	R	R	R	R	R	R	R	R	R	R	R	R	R	R	R	
Default	0	0	0	0	0	0	0	0	0	0	0	0	0	0	0	0	
Bit	15	14	13	12	11	10	9	8	7	6	5	4	3	2	1	0	
Name	Isochronous receive interrupt mask																
Type	R	R	R	R	R	R	R	R	R	R	R	R	R	RSC	RSC	RSC	RSC
Default	0	0	0	0	0	0	0	0	0	0	0	0	0	X	X	X	X

Register: **Isochronous receive interrupt mask**
 Offset: A8h set register
 ACh clear register
 Type: Read/Set/Clear, Read-Only
 Default: 0000 000Xh

4.27 Initial Bandwidth Available Register

The initial bandwidth available register value is loaded into the corresponding bus management CSR register on a system (hardware) or software reset. See Table 4–19 for a complete description of the register contents.

Bit	31	30	29	28	27	26	25	24	23	22	21	20	19	18	17	16
Name	Initial bandwidth available															
Type	R	R	R	R	R	R	R	R	R	R	R	R	R	R	R	R
Default	0	0	0	0	0	0	0	0	0	0	0	0	0	0	0	0
Bit	15	14	13	12	11	10	9	8	7	6	5	4	3	2	1	0
Name	Initial bandwidth available															
Type	R	R	R	R/W	R/W	R/W	R/W	R/W	R/W	R/W	R/W	R/W	R/W	R/W	R/W	R/W
Default	0	0	0	1	0	0	1	1	0	0	1	1	0	0	1	1

Register: **Initial bandwidth available**
 Offset: B0h
 Type: Read-Only, Read/Write
 Default: 0000 1333h

Table 4–19. Initial Bandwidth Available Register Description

BIT	FIELD NAME	TYPE	DESCRIPTION
31–13	RSVD	R	Reserved. Bits 31–13 return 0s when read.
12–0	InitBWAvailable	R/W	This field is reset to 1333h on a system (hardware) or software reset, and is not affected by a 1394 bus reset. The value of this field is loaded into the BANDWIDTH_AVAILABLE CSR register upon a G_RST, PCI_RST, or a 1394 bus reset.

4.28 Initial Channels Available High Register

The initial channels available high register value is loaded into the corresponding bus management CSR register on a system (hardware) or software reset. See Table 4–20 for a complete description of the register contents.

Bit	31	30	29	28	27	26	25	24	23	22	21	20	19	18	17	16
Name	Initial channels available high															
Type	R/W	R/W	R/W	R/W	R/W	R/W	R/W	R/W	R/W	R/W	R/W	R/W	R/W	R/W	R/W	R/W
Default	1	1	1	1	1	1	1	1	1	1	1	1	1	1	1	1
Bit	15	14	13	12	11	10	9	8	7	6	5	4	3	2	1	0
Name	Initial channels available high															
Type	R/W	R/W	R/W	R/W	R/W	R/W	R/W	R/W	R/W	R/W	R/W	R/W	R/W	R/W	R/W	R/W
Default	1	1	1	1	1	1	1	1	1	1	1	1	1	1	1	1

Register: **Initial channels available high**
 Offset: B4h
 Type: Read/Write
 Default: FFFF FFFFh

Table 4–20. Initial Channels Available High Register Description

BIT	FIELD NAME	TYPE	DESCRIPTION
31–0	InitChanAvailHi	R/W	This field is reset to FFFF_FFFFh on a system (hardware) or software reset, and is not affected by a 1394 bus reset. The value of this field is loaded into the CHANNELS_AVAILABLE_HI CSR register upon a G_RST, PCI_RST, or a 1394 bus reset.

4.29 Initial Channels Available Low Register

The initial channels available low register value is loaded into the corresponding bus management CSR register on a system (hardware) or software reset. See Table 4–21 for a complete description of the register contents.

Bit	31	30	29	28	27	26	25	24	23	22	21	20	19	18	17	16
Name	Initial channels available low															
Type	R/W	R/W	R/W	R/W	R/W	R/W	R/W	R/W	R/W	R/W	R/W	R/W	R/W	R/W	R/W	R/W
Default	1	1	1	1	1	1	1	1	1	1	1	1	1	1	1	1
Bit	15	14	13	12	11	10	9	8	7	6	5	4	3	2	1	0
Name	Initial channels available low															
Type	R/W	R/W	R/W	R/W	R/W	R/W	R/W	R/W	R/W	R/W	R/W	R/W	R/W	R/W	R/W	R/W
Default	1	1	1	1	1	1	1	1	1	1	1	1	1	1	1	1

Register: **Initial channels available low**
 Offset: B8h
 Type: Read/Write
 Default: FFFF FFFFh

Table 4–21. Initial Channels Available Low Register Description

BIT	FIELD NAME	TYPE	DESCRIPTION
31–0	InitChanAvailLo	R/W	This field is reset to FFFF_FFFFh on a system (hardware) or software reset, and is not affected by a 1394 bus reset. The value of this field is loaded into the CHANNELS_AVAILABLE_LO CSR register upon a G_RST, PCI_RST, or a 1394 bus reset.

4.30 Fairness Control Register

The fairness control register provides a mechanism by which software can direct the host controller to transmit multiple asynchronous requests during a fairness interval. See Table 4–22 for a complete description of the register contents.

Bit	31	30	29	28	27	26	25	24	23	22	21	20	19	18	17	16
Name	Fairness control															
Type	R	R	R	R	R	R	R	R	R	R	R	R	R	R	R	R
Default	0	0	0	0	0	0	0	0	0	0	0	0	0	0	0	0
Bit	15	14	13	12	11	10	9	8	7	6	5	4	3	2	1	0
Name	Fairness control															
Type	R	R	R	R	R	R	R	R	R/W	R/W	R/W	R/W	R/W	R/W	R/W	R/W
Default	0	0	0	0	0	0	0	0	0	0	0	0	0	0	0	0

Register: **Fairness control**
 Offset: DCh
 Type: Read-only
 Default: 0000 0000h

Table 4–22. Fairness Control Register Description

BIT	FIELD NAME	TYPE	DESCRIPTION
31–8	RSVD	R	Reserved. Bits 31–8 return 0s when read.
7–0	pri_req	R/W	This field specifies the maximum number of priority arbitration requests for asynchronous request packets that the link is permitted to make of the PHY layer during a fairness interval.

4.31 Link Control Register

The link control set/clear register provides the control flags that enable and configure the link core protocol portions of the TSB43AB21A device. It contains controls for the receiver and cycle timer. See Table 4–23 for a complete description of the register contents.

Bit	31	30	29	28	27	26	25	24	23	22	21	20	19	18	17	16
Name	Link control															
Type	R	R	R	R	R	R	R	R	R	RSC	RSCU	RSC	R	R	R	R
Default	0	0	0	0	0	0	0	0	0	X	X	X	0	0	0	0
Bit	15	14	13	12	11	10	9	8	7	6	5	4	3	2	1	0
Name	Link control															
Type	R	R	R	R	R	RSC	RSC	R	R	RS	R	R	R	R	R	R
Default	0	0	0	0	0	X	X	0	0	0	0	0	0	0	0	0

Register: **Link control**
 Offset: E0h set register
 E4h clear register
 Type: Read/Set/Clear/Update, Read/Set/Clear, Read-Only
 Default: 00X0 0X00h

Table 4–23. Link Control Register Description

BIT	FIELD NAME	TYPE	DESCRIPTION
31–23	RSVD	R	Reserved. Bits 31–23 return 0s when read.
22	cycleSource	RSC	When bit 22 is set to 1, the cycle timer uses an external source (CYCLEIN) to determine when to roll over the cycle timer. When this bit is cleared, the cycle timer rolls over when the timer reaches 3072 cycles of the 24.576-MHz clock (125 μs).
21	cycleMaster	RSCU	When bit 21 is set to 1, the TSB43AB21A device is root and it generates a cycle start packet every time the cycle timer rolls over, based on the setting of bit 22 (cycleSource). When bit 21 is cleared, the iOHCI-Lynx™ accepts received cycle start packets to maintain synchronization with the node which is sending them. Bit 21 is automatically cleared when bit 25 (cycleTooLong) in the interrupt event register at OHCI offset 80h/84h (see Section 4.21, <i>Interrupt Event Register</i>) is set to 1. Bit 21 cannot be set to 1 until bit 25 (cycleTooLong) is cleared.
20	CycleTimerEnable	RSC	When bit 20 is set to 1, the cycle timer offset counts cycles of the 24.576-MHz clock and rolls over at the appropriate time, based on the settings of the above bits. When this bit is cleared, the cycle timer offset does not count.
19–11	RSVD	R	Reserved. Bits 19–11 return 0s when read.
10	RcvPhyPkt	RSC	When bit 10 is set to 1, the receiver accepts incoming PHY packets into the AR request context if the AR request context is enabled. This bit does not control receipt of self-identification packets.
9	RcvSelfID	RSC	When bit 9 is set to 1, the receiver accepts incoming self-identification packets. Before setting this bit to 1, software must ensure that the self-ID buffer pointer register contains a valid address.
8–7	RSVD	R	Reserved. Bits 8 and 7 return 0s when read.
6	tag1SyncFilterLock	RS	When bit 6 is set to 1, bit 6 (tag1SyncFilter) in the isochronous receive context match register (see Section 4.46, <i>Isochronous Receive Context Match Register</i>) is set to 1 for all isochronous receive contexts. When bit 6 is cleared, bit 6 (tag1SyncFilter) in the isochronous receive context match register has read/write access. This bit is cleared when $\overline{G_RST}$ is asserted.
5–0	RSVD	R	Reserved. Bits 5–0 return 0s when read.

4.32 Node Identification Register

The node identification register contains the address of the node on which the iOHCI-Lynx™ chip resides and indicates the valid node number status. The 16-bit combination of the busNumber field (bits 15–6) and the NodeNumber field (bits 5–0) is referred to as the node ID. See Table 4–24 for a complete description of the register contents.

Bit	31	30	29	28	27	26	25	24	23	22	21	20	19	18	17	16
Name	Node identification															
Type	RU	RU	R	R	RU	R	R	R	R	R	R	R	R	R	R	R
Default	0	0	0	0	0	0	0	0	0	0	0	0	0	0	0	0
Bit	15	14	13	12	11	10	9	8	7	6	5	4	3	2	1	0
Name	Node identification															
Type	RWU	RWU	RWU	RWU	RWU	RWU	RWU	RWU	RWU	RWU	RU	RU	RU	RU	RU	RU
Default	1	1	1	1	1	1	1	1	1	1	X	X	X	X	X	X

Register: **Node identification**
 Offset: E8h
 Type: Read/Write/Update, Read/Update, Read-Only
 Default: 0000 FFXh

Table 4–24. Node Identification Register Description

BIT	FIELD NAME	TYPE	DESCRIPTION
31	iDValid	RU	Bit 31 indicates whether or not the TSB43AB21A device has a valid node number. It is cleared when a 1394 bus reset is detected and set to 1 when the TSB43AB21A device receives a new node number from its PHY layer.
30	root	RU	Bit 30 is set to 1 during the bus reset process if the attached PHY layer is root.
29–28	RSVD	R	Reserved. Bits 29 and 28 return 0s when read.
27	CPS	RU	Bit 27 is set to 1 if the PHY layer is reporting that cable power status is OK.
26–16	RSVD	R	Reserved. Bits 26–16 return 0s when read.
15–6	busNumber	RWU	This field identifies the specific 1394 bus the TSB43AB21A device belongs to when multiple 1394-compatible buses are connected via a bridge.
5–0	NodeNumber	RU	This field is the physical node number established by the PHY layer during self-identification. It is automatically set to the value received from the PHY layer after the self-identification phase. If the PHY layer sets the nodeNumber to 63, software must not set bit 15 (run) in the asynchronous context control register (see Section 4.40, <i>Asynchronous Context Control Register</i>) for either of the AT DMA contexts.

4.33 PHY Layer Control Register

The PHY layer control register reads from or writes to a PHY register. See Table 4–25 for a complete description of the register contents.

Bit	31	30	29	28	27	26	25	24	23	22	21	20	19	18	17	16
Name	PHY layer control															
Type	RU	R	R	R	RU	RU	RU	RU	RU	RU	RU	RU	RU	RU	RU	RU
Default	0	0	0	0	0	0	0	0	0	0	0	0	0	0	0	0
Bit	15	14	13	12	11	10	9	8	7	6	5	4	3	2	1	0
Name	PHY layer control															
Type	RWU	RWU	R	R	R/W	R/W	R/W	R/W	R/W	R/W	R/W	R/W	R/W	R/W	R/W	R/W
Default	0	0	0	0	0	0	0	0	0	0	0	0	0	0	0	0

Register: **PHY layer control**
 Offset: ECh
 Type: Read/Write/Update, Read/Write, Read/Update, Read-only
 Default: 0000 0000h

Table 4–25. PHY Control Register Description

BIT	FIELD NAME	TYPE	DESCRIPTION
31	rdDone	RU	Bit 31 is cleared to 0 by the TSB43AB21A device when either bit 15 (rdReg) or bit 14 (wrReg) is set to 1. This bit is set to 1 when a register transfer is received from the PHY layer.
30–28	RSVD	R	Reserved. Bits 30–28 return 0s when read.
27–24	rdAddr	RU	This field is the address of the register most recently received from the PHY layer.
23–16	rdData	RU	This field is the contents of a PHY register that has been read.
15	rdReg	RWU	Bit 15 is set to 1 by software to initiate a read request to a PHY register and is cleared by hardware when the request has been sent. Bits 14 (wrReg) and 15 (rdReg) must not both be set to 1 simultaneously.
14	wrReg	RWU	Bit 14 is set to 1 by software to initiate a write request to a PHY register and is cleared by hardware when the request has been sent. Bits 14 (wrReg) and 15 (rdReg) must not both be set to 1 simultaneously.
13–12	RSVD	R	Reserved. Bits 13 and 12 return 0s when read.
11–8	regAddr	R/W	This field is the address of the PHY register to be written or read.
7–0	wrData	R/W	This field is the data to be written to a PHY register and is ignored for reads.

4.34 Isochronous Cycle Timer Register

The isochronous cycle timer register indicates the current cycle number and offset. When the TSB43AB21A device is cycle master, this register is transmitted with the cycle start message. When the TSB43AB21A device is not cycle master, this register is loaded with the data field in an incoming cycle start. In the event that the cycle start message is not received, the fields can continue incrementing on their own (if programmed) to maintain a local time reference. See Table 4–26 for a complete description of the register contents.

Bit	31	30	29	28	27	26	25	24	23	22	21	20	19	18	17	16
Name	Isochronous cycle timer															
Type	RWU	RWU	RWU	RWU	RWU	RWU	RWU	RWU	RWU	RWU	RWU	RWU	RWU	RWU	RWU	RWU
Default	X	X	X	X	X	X	X	X	X	X	X	X	X	X	X	X
Bit	15	14	13	12	11	10	9	8	7	6	5	4	3	2	1	0
Name	Isochronous cycle timer															
Type	RWU	RWU	RWU	RWU	RWU	RWU	RWU	RWU	RWU	RWU	RWU	RWU	RWU	RWU	RWU	RWU
Default	X	X	X	X	X	X	X	X	X	X	X	X	X	X	X	X

Register: **Isochronous cycle timer**
 Offset: F0h
 Type: Read/Write/Update
 Default: XXXX XXXXh

Table 4–26. Isochronous Cycle Timer Register Description

BIT	FIELD NAME	TYPE	DESCRIPTION
31–25	cycleSeconds	RWU	This field counts seconds [rollovers from bits 24–12 (cycleCount field)] modulo 128.
24–12	cycleCount	RWU	This field counts cycles [rollovers from bits 11–0 (cycleOffset field)] modulo 8000.
11–0	cycleOffset	RWU	This field counts 24.576-MHz clocks modulo 3072, that is, 125 μs. If an external 8-kHz clock configuration is being used, this field must be cleared to 0s at each tick of the external clock.

4.35 Asynchronous Request Filter High Register

The asynchronous request filter high set/clear register enables asynchronous receive requests on a per-node basis, and handles the upper node IDs. When a packet is destined for either the physical request context or the ARRQ context, the source node ID is examined. If the bit corresponding to the node ID is not set to 1 in this register, the packet is not acknowledged and the request is not queued. The node ID comparison is done if the source node is on the same bus as the TSB43AB21A device. Nonlocal bus-sourced packets are not acknowledged unless bit 31 in this register is set to 1. See Table 4–27 for a complete description of the register contents.

Bit	31	30	29	28	27	26	25	24	23	22	21	20	19	18	17	16
Name	Asynchronous request filter high															
Type	RSC	RSC	RSC	RSC	RSC	RSC	RSC	RSC	RSC	RSC	RSC	RSC	RSC	RSC	RSC	RSC
Default	0	0	0	0	0	0	0	0	0	0	0	0	0	0	0	0
Bit	15	14	13	12	11	10	9	8	7	6	5	4	3	2	1	0
Name	Asynchronous request filter high															
Type	RSC	RSC	RSC	RSC	RSC	RSC	RSC	RSC	RSC	RSC	RSC	RSC	RSC	RSC	RSC	RSC
Default	0	0	0	0	0	0	0	0	0	0	0	0	0	0	0	0

Register: **Asynchronous request filter high**
 Offset: 100h set register
 104h clear register
 Type: Read/Set/Clear
 Default: 0000 0000h

Table 4–27. Asynchronous Request Filter High Register Description

BIT	FIELD NAME	TYPE	DESCRIPTION
31	asynReqAllBuses	RSC	If bit 31 is set to 1, all asynchronous requests received by the TSB43AB21A device from nonlocal bus nodes are accepted.
30	asynReqResource62	RSC	If bit 30 is set to 1 for local bus node number 62, asynchronous requests received by the TSB43AB21A device from that node are accepted.
29	asynReqResource61	RSC	If bit 29 is set to 1 for local bus node number 61, asynchronous requests received by the TSB43AB21A device from that node are accepted.
28	asynReqResource60	RSC	If bit 28 is set to 1 for local bus node number 60, asynchronous requests received by the TSB43AB21A device from that node are accepted.
27	asynReqResource59	RSC	If bit 27 is set to 1 for local bus node number 59, asynchronous requests received by the TSB43AB21A device from that node are accepted.
26	asynReqResource58	RSC	If bit 26 is set to 1 for local bus node number 58, asynchronous requests received by the TSB43AB21A device from that node are accepted.
25	asynReqResource57	RSC	If bit 25 is set to 1 for local bus node number 57, asynchronous requests received by the TSB43AB21A device from that node are accepted.
24	asynReqResource56	RSC	If bit 24 is set to 1 for local bus node number 56, asynchronous requests received by the TSB43AB21A device from that node are accepted.
23	asynReqResource55	RSC	If bit 23 is set to 1 for local bus node number 55, asynchronous requests received by the TSB43AB21A device from that node are accepted.
22	asynReqResource54	RSC	If bit 22 is set to 1 for local bus node number 54, asynchronous requests received by the TSB43AB21A device from that node are accepted.
21	asynReqResource53	RSC	If bit 21 is set to 1 for local bus node number 53, asynchronous requests received by the TSB43AB21A device from that node are accepted.
20	asynReqResource52	RSC	If bit 20 is set to 1 for local bus node number 52, asynchronous requests received by the TSB43AB21A device from that node are accepted.
19	asynReqResource51	RSC	If bit 19 is set to 1 for local bus node number 51, asynchronous requests received by the TSB43AB21A device from that node are accepted.

Table 4–27. Asynchronous Request Filter High Register Description (Continued)

BIT	FIELD NAME	TYPE	DESCRIPTION
18	asynReqResource50	RSC	If bit 18 is set to 1 for local bus node number 50, asynchronous requests received by the TSB43AB21A device from that node are accepted.
17	asynReqResource49	RSC	If bit 17 is set to 1 for local bus node number 49, asynchronous requests received by the TSB43AB21A device from that node are accepted.
16	asynReqResource48	RSC	If bit 16 is set to 1 for local bus node number 48, asynchronous requests received by the TSB43AB21A device from that node are accepted.
15	asynReqResource47	RSC	If bit 15 is set to 1 for local bus node number 47, asynchronous requests received by the TSB43AB21A device from that node are accepted.
14	asynReqResource46	RSC	If bit 14 is set to 1 for local bus node number 46, asynchronous requests received by the TSB43AB21A device from that node are accepted.
13	asynReqResource45	RSC	If bit 13 is set to 1 for local bus node number 45, asynchronous requests received by the TSB43AB21A device from that node are accepted.
12	asynReqResource44	RSC	If bit 12 is set to 1 for local bus node number 44, asynchronous requests received by the TSB43AB21A device from that node are accepted.
11	asynReqResource43	RSC	If bit 11 is set to 1 for local bus node number 43, asynchronous requests received by the TSB43AB21A device from that node are accepted.
10	asynReqResource42	RSC	If bit 10 is set to 1 for local bus node number 42, asynchronous requests received by the TSB43AB21A device from that node are accepted.
9	asynReqResource41	RSC	If bit 9 is set to 1 for local bus node number 41, asynchronous requests received by the TSB43AB21A device from that node are accepted.
8	asynReqResource40	RSC	If bit 8 is set to 1 for local bus node number 40, asynchronous requests received by the TSB43AB21A device from that node are accepted.
7	asynReqResource39	RSC	If bit 7 is set to 1 for local bus node number 39, asynchronous requests received by the TSB43AB21A device from that node are accepted.
6	asynReqResource38	RSC	If bit 6 is set to 1 for local bus node number 38, asynchronous requests received by the TSB43AB21A device from that node are accepted.
5	asynReqResource37	RSC	If bit 5 is set to 1 for local bus node number 37, asynchronous requests received by the TSB43AB21A device from that node are accepted.
4	asynReqResource36	RSC	If bit 4 is set to 1 for local bus node number 36, asynchronous requests received by the TSB43AB21A device from that node are accepted.
3	asynReqResource35	RSC	If bit 3 is set to 1 for local bus node number 35, asynchronous requests received by the TSB43AB21A device from that node are accepted.
2	asynReqResource34	RSC	If bit 2 is set to 1 for local bus node number 34, asynchronous requests received by the TSB43AB21A device from that node are accepted.
1	asynReqResource33	RSC	If bit 1 is set to 1 for local bus node number 33, asynchronous requests received by the TSB43AB21A device from that node are accepted.
0	asynReqResource32	RSC	If bit 0 is set to 1 for local bus node number 32, asynchronous requests received by the TSB43AB21A device from that node are accepted.

4.36 Asynchronous Request Filter Low Register

The asynchronous request filter low set/clear register enables asynchronous receive requests on a per-node basis, and handles the lower node IDs. Other than filtering different node IDs, this register behaves identically to the asynchronous request filter high register. See Table 4–28 for a complete description of the register contents.

Bit	31	30	29	28	27	26	25	24	23	22	21	20	19	18	17	16
Name	Asynchronous request filter low															
Type	RSC	RSC	RSC	RSC	RSC	RSC	RSC	RSC	RSC	RSC	RSC	RSC	RSC	RSC	RSC	RSC
Default	0	0	0	0	0	0	0	0	0	0	0	0	0	0	0	0
Bit	15	14	13	12	11	10	9	8	7	6	5	4	3	2	1	0
Name	Asynchronous request filter low															
Type	RSC	RSC	RSC	RSC	RSC	RSC	RSC	RSC	RSC	RSC	RSC	RSC	RSC	RSC	RSC	RSC
Default	0	0	0	0	0	0	0	0	0	0	0	0	0	0	0	0

Register: **Asynchronous request filter low**

Offset: 108h set register
10Ch clear register

Type: Read/Set/Clear

Default: 0000 0000h

Table 4–28. Asynchronous Request Filter Low Register Description

BIT	FIELD NAME	TYPE	DESCRIPTION
31	asynReqResource31	RSC	If bit 31 is set to 1 for local bus node number 31, asynchronous requests received by the TSB43AB21A device from that node are accepted.
30	asynReqResource30	RSC	If bit 30 is set to 1 for local bus node number 30, asynchronous requests received by the TSB43AB21A device from that node are accepted.
29–2	asynReqResourcen	RSC	Bits 29 through 2 (asynReqResourcen, where n = 29, 28, 27, ..., 2) follow the same pattern as bits 31 and 30.
1	asynReqResource1	RSC	If bit 1 is set to 1 for local bus node number 1, asynchronous requests received by the TSB43AB21A device from that node are accepted.
0	asynReqResource0	RSC	If bit 0 is set to 1 for local bus node number 0, asynchronous requests received by the TSB43AB21A device from that node are accepted.

4.37 Physical Request Filter High Register

The physical request filter high set/clear register enables physical receive requests on a per-node basis, and handles the upper node IDs. When a packet is destined for the physical request context, and the node ID has been compared against the ARRQ registers, then the comparison is done again with this register. If the bit corresponding to the node ID is not set to 1 in this register, the request is handled by the ARRQ context instead of the physical request context. The node ID comparison is done if the source node is on the same bus as the TSB43AB21A device. Nonlocal bus-sourced packets are not acknowledged unless bit 31 in this register is set to 1. See Table 4–29 for a complete description of the register contents.

Bit	31	30	29	28	27	26	25	24	23	22	21	20	19	18	17	16
Name	Physical request filter high															
Type	RSC	RSC	RSC	RSC	RSC	RSC	RSC	RSC	RSC	RSC	RSC	RSC	RSC	RSC	RSC	RSC
Default	0	0	0	0	0	0	0	0	0	0	0	0	0	0	0	0
Bit	15	14	13	12	11	10	9	8	7	6	5	4	3	2	1	0
Name	Physical request filter high															
Type	RSC	RSC	RSC	RSC	RSC	RSC	RSC	RSC	RSC	RSC	RSC	RSC	RSC	RSC	RSC	RSC
Default	0	0	0	0	0	0	0	0	0	0	0	0	0	0	0	0

Register: **Physical request filter high**
 Offset: 110h set register
 114h clear register
 Type: Read/Set/Clear
 Default: 0000 0000h

Table 4–29. Physical Request Filter High Register Description

BIT	FIELD NAME	TYPE	DESCRIPTION
31	physReqAllBusses	RSC	If bit 31 is set to 1, all asynchronous requests received by the TSB43AB21A device from nonlocal bus nodes are accepted. Bit 31 is not cleared by a PCI_RST.
30	physReqResource62	RSC	If bit 30 is set to 1 for local bus node number 62, physical requests received by the TSB43AB21A device from that node are handled through the physical request context.
29	physReqResource61	RSC	If bit 29 is set to 1 for local bus node number 61, physical requests received by the TSB43AB21A device from that node are handled through the physical request context.
28	physReqResource60	RSC	If bit 28 is set to 1 for local bus node number 60, physical requests received by the TSB43AB21A device from that node are handled through the physical request context.
27	physReqResource59	RSC	If bit 27 is set to 1 for local bus node number 59, physical requests received by the TSB43AB21A device from that node are handled through the physical request context.
26	physReqResource58	RSC	If bit 26 is set to 1 for local bus node number 58, physical requests received by the TSB43AB21A device from that node are handled through the physical request context.
25	physReqResource57	RSC	If bit 25 is set to 1 for local bus node number 57, physical requests received by the TSB43AB21A device from that node are handled through the physical request context.
24	physReqResource56	RSC	If bit 24 is set to 1 for local bus node number 56, physical requests received by the TSB43AB21A device from that node are handled through the physical request context.
23	physReqResource55	RSC	If bit 23 is set to 1 for local bus node number 55, physical requests received by the TSB43AB21A device from that node are handled through the physical request context.
22	physReqResource54	RSC	If bit 22 is set to 1 for local bus node number 54, physical requests received by the TSB43AB21A device from that node are handled through the physical request context.
21	physReqResource53	RSC	If bit 21 is set to 1 for local bus node number 53, physical requests received by the TSB43AB21A device from that node are handled through the physical request context.
20	physReqResource52	RSC	If bit 20 is set to 1 for local bus node number 52, physical requests received by the TSB43AB21A device from that node are handled through the physical request context.
19	physReqResource51	RSC	If bit 19 is set to 1 for local bus node number 51, physical requests received by the TSB43AB21A device from that node are handled through the physical request context.

Table 4–29. Physical Request Filter High Register Description (Continued)

BIT	FIELD NAME	TYPE	DESCRIPTION
18	physReqResource50	RSC	If bit 18 is set to 1 for local bus node number 50, physical requests received by the TSB43AB21A device from that node are handled through the physical request context.
17	physReqResource49	RSC	If bit 17 is set to 1 for local bus node number 49, physical requests received by the TSB43AB21A device from that node are handled through the physical request context.
16	physReqResource48	RSC	If bit 16 is set to 1 for local bus node number 48, physical requests received by the TSB43AB21A device from that node are handled through the physical request context.
15	physReqResource47	RSC	If bit 15 is set to 1 for local bus node number 47, physical requests received by the TSB43AB21A device from that node are handled through the physical request context.
14	physReqResource46	RSC	If bit 14 is set to 1 for local bus node number 46, physical requests received by the TSB43AB21A device from that node are handled through the physical request context.
13	physReqResource45	RSC	If bit 13 is set to 1 for local bus node number 45, physical requests received by the TSB43AB21A device from that node are handled through the physical request context.
12	physReqResource44	RSC	If bit 12 is set to 1 for local bus node number 44, physical requests received by the TSB43AB21A device from that node are handled through the physical request context.
11	physReqResource43	RSC	If bit 11 is set to 1 for local bus node number 43, physical requests received by the TSB43AB21A device from that node are handled through the physical request context.
10	physReqResource42	RSC	If bit 10 is set to 1 for local bus node number 42, physical requests received by the TSB43AB21A device from that node are handled through the physical request context.
9	physReqResource41	RSC	If bit 9 is set to 1 for local bus node number 41, physical requests received by the TSB43AB21A device from that node are handled through the physical request context.
8	physReqResource40	RSC	If bit 8 is set to 1 for local bus node number 40, physical requests received by the TSB43AB21A device from that node are handled through the physical request context.
7	physReqResource39	RSC	If bit 7 is set to 1 for local bus node number 39, physical requests received by the TSB43AB21A device from that node are handled through the physical request context.
6	physReqResource38	RSC	If bit 6 is set to 1 for local bus node number 38, physical requests received by the TSB43AB21A device from that node are handled through the physical request context.
5	physReqResource37	RSC	If bit 5 is set to 1 for local bus node number 37, physical requests received by the TSB43AB21A device from that node are handled through the physical request context.
4	physReqResource36	RSC	If bit 4 is set to 1 for local bus node number 36, physical requests received by the TSB43AB21A device from that node are handled through the physical request context.
3	physReqResource35	RSC	If bit 3 is set to 1 for local bus node number 35, physical requests received by the TSB43AB21A device from that node are handled through the physical request context.
2	physReqResource34	RSC	If bit 2 is set to 1 for local bus node number 34, physical requests received by the TSB43AB21A device from that node are handled through the physical request context.
1	physReqResource33	RSC	If bit 1 is set to 1 for local bus node number 33, physical requests received by the TSB43AB21A device from that node are handled through the physical request context.
0	physReqResource32	RSC	If bit 0 is set to 1 for local bus node number 32, physical requests received by the TSB43AB21A device from that node are handled through the physical request context.

4.38 Physical Request Filter Low Register

The physical request filter low set/clear register enables physical receive requests on a per-node basis, and handles the lower node IDs. When a packet is destined for the physical request context and the node ID has been compared against the asynchronous request filter registers, then the node ID comparison is done again with this register. If the bit corresponding to the node ID is not set to 1 in this register, the request is handled by the asynchronous request context instead of the physical request context. See Table 4–30 for a complete description of the register contents.

Bit	31	30	29	28	27	26	25	24	23	22	21	20	19	18	17	16
Name	Physical request filter low															
Type	RSC	RSC	RSC	RSC	RSC	RSC	RSC	RSC	RSC	RSC	RSC	RSC	RSC	RSC	RSC	RSC
Default	0	0	0	0	0	0	0	0	0	0	0	0	0	0	0	0
Bit	15	14	13	12	11	10	9	8	7	6	5	4	3	2	1	0
Name	Physical request filter low															
Type	RSC	RSC	RSC	RSC	RSC	RSC	RSC	RSC	RSC	RSC	RSC	RSC	RSC	RSC	RSC	RSC
Default	0	0	0	0	0	0	0	0	0	0	0	0	0	0	0	0

Register: **Physical request filter low**
 Offset: 118h set register
 11Ch clear register
 Type: Read/Set/Clear
 Default: 0000 0000h

Table 4–30. Physical Request Filter Low Register Description

BIT	FIELD NAME	TYPE	DESCRIPTION
31	physReqResource31	RSC	If bit 31 is set to 1 for local bus node number 31, physical requests received by the TSB43AB21A device from that node are handled through the physical request context.
30	physReqResource30	RSC	If bit 30 is set to 1 for local bus node number 30, physical requests received by the TSB43AB21A device from that node are handled through the physical request context.
29–2	physReqResourcen	RSC	Bits 29 through 2 (physReqResourcen, where n = 29, 28, 27, ..., 2) follow the same pattern as bits 31 and 30.
1	physReqResource1	RSC	If bit 1 is set to 1 for local bus node number 1, physical requests received by the TSB43AB21A device from that node are handled through the physical request context.
0	physReqResource0	RSC	If bit 0 is set to 1 for local bus node number 0, physical requests received by the TSB43AB21A device from that node are handled through the physical request context.

4.39 Physical Upper Bound Register (Optional Register)

The physical upper bound register is an optional register and is not implemented. This register returns all 0s when read.

Bit	31	30	29	28	27	26	25	24	23	22	21	20	19	18	17	16
Name	Physical upper bound															
Type	R	R	R	R	R	R	R	R	R	R	R	R	R	R	R	R
Default	0	0	0	0	0	0	0	0	0	0	0	0	0	0	0	0
Bit	15	14	13	12	11	10	9	8	7	6	5	4	3	2	1	0
Name	Physical upper bound															
Type	R	R	R	R	R	R	R	R	R	R	R	R	R	R	R	R
Default	0	0	0	0	0	0	0	0	0	0	0	0	0	0	0	0

Register: **Physical upper bound**
 Offset: 120h
 Type: Read-only
 Default: 0000 0000h

4.40 Asynchronous Context Control Register

The asynchronous context control set/clear register controls the state and indicates status of the DMA context. See Table 4–31 for a complete description of the register contents.

Bit	31	30	29	28	27	26	25	24	23	22	21	20	19	18	17	16
Name	Asynchronous context control															
Type	R	R	R	R	R	R	R	R	R	R	R	R	R	R	R	R
Default	0	0	0	0	0	0	0	0	0	0	0	0	0	0	0	0
Bit	15	14	13	12	11	10	9	8	7	6	5	4	3	2	1	0
Name	Asynchronous context control															
Type	RSCU	R	R	RSU	RU	RU	R	R	RU	RU	RU	RU	RU	RU	RU	RU
Default	0	0	0	X	0	0	0	0	X	X	X	X	X	X	X	X

Register: **Asynchronous context control**

Offset: 180h set register [ATRQ]
 184h clear register [ATRQ]
 1A0h set register [ATRS]
 1A4h clear register [ATRS]
 1C0h set register [ARRQ]
 1C4h clear register [ARRQ]
 1E0h set register [ARRS]
 1E4h clear register [ARRS]

Type: Read/Set/Clear/Update, read/set/update, read/update, read-only

Default: 0000 X0XXh

Table 4–31. Asynchronous Context Control Register Description

BIT	FIELD NAME	TYPE	DESCRIPTION
31–16	RSVD	R	Reserved. Bits 31–16 return 0s when read.
15	run	RSCU	Bit 15 is set to 1 by software to enable descriptor processing for the context and cleared by software to stop descriptor processing. The TSB43AB21A device changes this bit only on a system (hardware) or software reset.
14–13	RSVD	R	Reserved. Bits 14 and 13 return 0s when read.
12	wake	RSU	Software sets bit 12 to 1 to cause the TSB43AB21A device to continue or resume descriptor processing. The TSB43AB21A device clears this bit on every descriptor fetch.
11	dead	RU	The TSB43AB21A device sets bit 11 to 1 when it encounters a fatal error, and clears the bit when software clears bit 15 (run). Asynchronous contexts supporting out-of-order pipelining provide unique ContextControl.dead functionality. See Section 7.7 in the <i>1394 Open Host Controller Interface Specification</i> (Revision 1.1) for more information.
10	active	RU	The TSB43AB21A device sets bit 10 to 1 when it is processing descriptors.
9–8	RSVD	R	Reserved. Bits 9 and 8 return 0s when read.
7–5	spd	RU	This field indicates the speed at which a packet was received or transmitted and only contains meaningful information for receive contexts. This field is encoded as: 000 = 100M bits/sec 001 = 200M bits/sec 010 = 400M bits/sec All other values are reserved.
4–0	eventcode	RU	This field holds the acknowledge sent by the link core for this packet or an internally generated error code if the packet was not transferred successfully.

4.41 Asynchronous Context Command Pointer Register

The asynchronous context command pointer register contains a pointer to the address of the first descriptor block that the TSB43AB21A device accesses when software enables the context by setting bit 15 (run) in the asynchronous context control register (see Section 4.40, *Asynchronous Context Control Register*) to 1. See Table 4–32 for a complete description of the register contents.

Bit	31	30	29	28	27	26	25	24	23	22	21	20	19	18	17	16
Name	Asynchronous context command pointer															
Type	RWU	RWU	RWU	RWU	RWU	RWU	RWU	RWU	RWU	RWU	RWU	RWU	RWU	RWU	RWU	RWU
Default	X	X	X	X	X	X	X	X	X	X	X	X	X	X	X	X
Bit	15	14	13	12	11	10	9	8	7	6	5	4	3	2	1	0
Name	Asynchronous context command pointer															
Type	RWU	RWU	RWU	RWU	RWU	RWU	RWU	RWU	RWU	RWU	RWU	RWU	RWU	RWU	RWU	RWU
Default	X	X	X	X	X	X	X	X	X	X	X	X	X	X	X	X

Register: **Asynchronous context command pointer**

Offset: 18Ch [ATRQ]

1ACh [ATRS]

1CCh [ARRQ]

1ECh [ARRS]

Type: Read/Write/Update

Default: XXXX XXXXh

Table 4–32. Asynchronous Context Command Pointer Register Description

BIT	FIELD NAME	TYPE	DESCRIPTION
31–4	descriptorAddress	RWU	Contains the upper 28 bits of the address of a 16-byte aligned descriptor block.
3–0	Z	RWU	Indicates the number of contiguous descriptors at the address pointed to by the descriptor address. If Z is 0, it indicates that the descriptorAddress field (bits 31–4) is not valid.

4.42 Isochronous Transmit Context Control Register

The isochronous transmit context control set/clear register controls options, state, and status for the isochronous transmit DMA contexts. The *n* value in the following register addresses indicates the context number (*n* = 0, 1, 2, 3, ..., 7). See Table 4–33 for a complete description of the register contents.

Bit	31	30	29	28	27	26	25	24	23	22	21	20	19	18	17	16
Name	Isochronous transmit context control															
Type	RSCU	RSC	RSC	RSC	RSC	RSC	RSC	RSC	RSC	RSC	RSC	RSC	RSC	RSC	RSC	RSC
Default	X	X	X	X	X	X	X	X	X	X	X	X	X	X	X	X
Bit	15	14	13	12	11	10	9	8	7	6	5	4	3	2	1	0
Name	Isochronous transmit context control															
Type	RSC	R	R	RSU	RU	RU	R	R	RU	RU	RU	RU	RU	RU	RU	RU
Default	0	0	0	X	0	0	0	0	X	X	X	X	X	X	X	X

Register: **Isochronous transmit context control**

Offset: 200h + (16 x *n*) set register
204h + (16 x *n*) clear register

Type: Read/Set/Clear/Update, read/set/clear, read/set/update, read/update, read-only

Default: XXXX X0XXh

Table 4–33. Isochronous Transmit Context Control Register Description

BIT	FIELD NAME	TYPE	DESCRIPTION
31	cycleMatchEnable	RSCU	When bit 31 is set to 1, processing occurs such that the packet described by the context first descriptor block is transmitted in the cycle whose number is specified in the cycleMatch field (bits 30–16). The cycleMatch field (bits 30–16) must match the low-order two bits of cycleSeconds and the 13-bit cycleCount field in the cycle start packet that is sent or received immediately before isochronous transmission begins. Since the isochronous transmit DMA controller may work ahead, the processing of the first descriptor block may begin slightly in advance of the actual cycle in which the first packet is transmitted. The effects of this bit, however, are impacted by the values of other bits in this register and are explained in the <i>1394 Open Host Controller Interface Specification</i> . Once the context has become active, hardware clears this bit.
30–16	cycleMatch	RSC	This field contains a 15-bit value, corresponding to the low-order two bits of the isochronous cycle timer register at OHCI offset F0h (see Section 4.34, <i>Isochronous Cycle Timer Register</i>) cycleSeconds field (bits 31–25) and the cycleCount field (bits 24–12). If bit 31 (cycleMatchEnable) is set to 1, this isochronous transmit DMA context becomes enabled for transmits when the low-order two bits of the isochronous cycle timer register at OHCI offset F0h cycleSeconds field (bits 31–25) and the cycleCount field (bits 24–12) value equal this field (cycleMatch) value.
15	run	RSC	Bit 15 is set to 1 by software to enable descriptor processing for the context and cleared by software to stop descriptor processing. The TSB43AB21A device changes this bit only on a system (hardware) or software reset.
14–13	RSVD	R	Reserved. Bits 14 and 13 return 0s when read.
12	wake	RSU	Software sets bit 12 to 1 to cause the TSB43AB21A device to continue or resume descriptor processing. The TSB43AB21A device clears this bit on every descriptor fetch.
11	dead	RU	The TSB43AB21A device sets bit 11 to 1 when it encounters a fatal error, and clears the bit when software clears bit 15 (run) to 0.
10	active	RU	The TSB43AB21A device sets bit 10 to 1 when it is processing descriptors.
9–8	RSVD	R	Reserved. Bits 9 and 8 return 0s when read.
7–5	spd	RU	This field is not meaningful for isochronous transmit contexts.
4–0	event code	RU	Following an OUTPUT_LAST* command, the error code is indicated in this field. Possible values are: ack_complete, evt_descriptor_read, evt_data_read, and evt_unknown.

† On an overflow for each running context, the isochronous transmit DMA supports up to 7 cycle skips, when the following are true:

1. Bit 11 (dead) in either the isochronous transmit or receive context control register is set to 1.
2. Bits 4–0 (eventcode field) in either the isochronous transmit or receive context control register is set to evt_timeout.
3. Bit 24 (unrecoverableError) in the interrupt event register at OHCI offset 80h/84h (see Section 4.21, *Interrupt Event Register*) is set to 1.

4.43 Isochronous Transmit Context Command Pointer Register

The isochronous transmit context command pointer register contains a pointer to the address of the first descriptor block that the TSB43AB21A device accesses when software enables an isochronous transmit context by setting bit 15 (run) in the isochronous transmit context control register (see Section 4.42, *Isochronous Transmit Context Control Register*) to 1. The isochronous transmit DMA context command pointer can be read when a context is active. The n value in the following register addresses indicates the context number (n = 0, 1, 2, 3, ..., 7).

Bit	31	30	29	28	27	26	25	24	23	22	21	20	19	18	17	16
Name	Isochronous transmit context command pointer															
Type	R	R	R	R	R	R	R	R	R	R	R	R	R	R	R	R
Default	X	X	X	X	X	X	X	X	X	X	X	X	X	X	X	X
Bit	15	14	13	12	11	10	9	8	7	6	5	4	3	2	1	0
Name	Isochronous transmit context command pointer															
Type	R	R	R	R	R	R	R	R	R	R	R	R	R	R	R	R
Default	X	X	X	X	X	X	X	X	X	X	X	X	X	X	X	X

Register: **Isochronous transmit context command pointer**
 Offset: 20Ch + (16 x n)
 Type: Read-Only
 Default: XXXX XXXXh

4.44 Isochronous Receive Context Control Register

The isochronous receive context control set/clear register controls options, state, and status for the isochronous receive DMA contexts. The n value in the following register addresses indicates the context number (n = 0, 1, 2, 3). See Table 4–34 for a complete description of the register contents.

Bit	31	30	29	28	27	26	25	24	23	22	21	20	19	18	17	16
Name	Isochronous receive context control															
Type	RSC	RSC	RSCU	RSC	RSC	R	R	R	R	R	R	R	R	R	R	R
Default	X	X	X	X	X	0	0	0	0	0	0	0	0	0	0	0
Bit	15	14	13	12	11	10	9	8	7	6	5	4	3	2	1	0
Name	Isochronous receive context control															
Type	RSCU	R	R	RSU	RU	RU	R	R	RU	RU	RU	RU	RU	RU	RU	RU
Default	0	0	0	X	0	0	0	0	X	X	X	X	X	X	X	X

Register: **Isochronous receive context control**
 Offset: 400h + (32 x n) set register
 404h + (32 x n) clear register
 Type: Read/Set/Clear/Update, Read/Set/Clear, Read/Set/Update, Read/Update, Read-Only
 Default: XX00 X0XXh

Table 4–34. Isochronous Receive Context Control Register Description

BIT	FIELD NAME	TYPE	DESCRIPTION
31	bufferFill	RSC	When bit 31 is set to 1, received packets are placed back-to-back to completely fill each receive buffer. When this bit is cleared, each received packet is placed in a single buffer. If bit 28 (multiChanMode) is set to 1, this bit must also be set to 1. The value of this bit must not be changed while bit 10 (active) or bit 15 (run) is set to 1.
30	isochHeader	RSC	When bit 30 is set to 1, received isochronous packets include the complete 4-byte isochronous packet header seen by the link layer. The end of the packet is marked with a xferStatus in the first doublet, and a 16-bit timeStamp indicating the time of the most recently received (or sent) cycleStart packet. When this bit is cleared, the packet header is stripped from received isochronous packets. The packet header, if received, immediately precedes the packet payload. The value of this bit must not be changed while bit 10 (active) or bit 15 (run) is set to 1.

Table 4–34. Isochronous Receive Context Control Register Description (Continued)

BIT	FIELD NAME	TYPE	DESCRIPTION
29	cycleMatchEnable	RSCU	When bit 29 is set to 1 and the 13-bit cycleMatch field (bits 24–12) in the isochronous receive context match register (See Section 4.46, <i>Isochronous Receive Context Match Register</i>) matches the 13-bit cycleCount field in the cycleStart packet, the context begins running. The effects of this bit, however, are impacted by the values of other bits in this register. Once the context has become active, hardware clears this bit. The value of this bit must not be changed while bit 10 (active) or bit 15 (run) is set to 1.
28	multiChanMode	RSC	When bit 28 is set to 1, the corresponding isochronous receive DMA context receives packets for all isochronous channels enabled in the isochronous receive channel mask high register at OHCI offset 70h/74h (see Section 4.19, <i>Isochronous Receive Channel Mask High Register</i>) and isochronous receive channel mask low register at OHCI offset 78h/7Ch (see Section 4.20, <i>Isochronous Receive Channel Mask Low Register</i>). The isochronous channel number specified in the isochronous receive context match register (see Section 4.46, <i>Isochronous Receive Context Match Register</i>) is ignored. When this bit is cleared, the isochronous receive DMA context receives packets for the single channel specified in the isochronous receive context match register (see Section 4.46, <i>Isochronous Receive Context Match Register</i>). Only one isochronous receive DMA context may use the isochronous receive channel mask registers (see Sections 4.19, <i>Isochronous Receive Channel Mask High Register</i> , and 4.20, <i>Isochronous Receive Channel Mask Low Register</i>). If more than one isochronous receive context control register has this bit set, the results are undefined. The value of this bit must not be changed while bit 10 (active) or bit 15 (run) is set to 1.
27	dualBufferMode	RSC	When bit 27 is set to 1, receive packets are separated into first and second payload and streamed independently to the firstBuffer series and secondBuffer series as described in Section 10.2.3 in the <i>1394 Open Host Controller Interface Specification</i> . Also, when bit 27 is set to 1, both bits 28 (multiChanMode) and 31 (bufferFill) are cleared to 0. The value of this bit does not change when either bit 10 (active) or bit 15 (run) is set to 1.
26–16	RSVD	R	Reserved. Bits 26–16 return 0s when read.
15	run	RSCU	Bit 15 is set to 1 by software to enable descriptor processing for the context and cleared by software to stop descriptor processing. The TSB43AB21A device changes this bit only on a system (hardware) or software reset.
14–13	RSVD	R	Reserved. Bits 14 and 13 return 0s when read.
12	wake	RSU	Software sets bit 12 to 1 to cause the TSB43AB21A device to continue or resume descriptor processing. The TSB43AB21A device clears this bit on every descriptor fetch.
11	dead	RU	The TSB43AB21A device sets bit 11 to 1 when it encounters a fatal error, and clears the bit when software clears bit 15 (run).
10	active	RU	The TSB43AB21A device sets bit 10 to 1 when it is processing descriptors.
9–8	RSVD	R	Reserved. Bits 9 and 8 return 0s when read.
7–5	spd	RU	This field indicates the speed at which the packet was received. 000 = 100M bits/sec 001 = 200M bits/sec 010 = 400M bits/sec All other values are reserved.
4–0	event code	RU	For bufferFill mode, possible values are: ack_complete, evt_descriptor_read, evt_data_write, and evt_unknown. Packets with data errors (either dataLength mismatches or dataCRC errors) and packets for which a FIFO overrun occurred are backed out. For packet-per-buffer mode, possible values are: ack_complete, ack_data_error, evt_long_packet, evt_overrun, evt_descriptor_read, evt_data_write, and evt_unknown.

4.45 Isochronous Receive Context Command Pointer Register

The isochronous receive context command pointer register contains a pointer to the address of the first descriptor block that the TSB43AB21A device accesses when software enables an isochronous receive context by setting bit 15 (run) in the isochronous receive context control register (see Section 4.44, *Isochronous Receive Context Control Register*) to 1. The n value in the following register addresses indicates the context number (n = 0, 1, 2, 3).

Bit	31	30	29	28	27	26	25	24	23	22	21	20	19	18	17	16
Name	Isochronous receive context command pointer															
Type	R	R	R	R	R	R	R	R	R	R	R	R	R	R	R	R
Default	X	X	X	X	X	X	X	X	X	X	X	X	X	X	X	X
Bit	15	14	13	12	11	10	9	8	7	6	5	4	3	2	1	0
Name	Isochronous receive context command pointer															
Type	R	R	R	R	R	R	R	R	R	R	R	R	R	R	R	R
Default	X	X	X	X	X	X	X	X	X	X	X	X	X	X	X	X

Register: **Isochronous receive context command pointer**
 Offset: 40Ch + (32 x n)
 Type: Read-Only
 Default: XXXX XXXXh

4.46 Isochronous Receive Context Match Register

The isochronous receive context match register starts an isochronous receive context running on a specified cycle number, filters incoming isochronous packets based on tag values, and waits for packets with a specified synchronous value. The *n* value in the following register addresses indicates the context number (*n* = 0, 1, 2, 3). See Table 4–35 for a complete description of the register contents.

Bit	31	30	29	28	27	26	25	24	23	22	21	20	19	18	17	16
Name	Isochronous receive context match															
Type	R/W	R/W	R/W	R/W	R	R/W	R/W	R/W	R/W	R/W	R/W	R/W	R/W	R/W	R/W	R/W
Default	X	X	X	X	0	0	0	X	X	X	X	X	X	X	X	X
Bit	15	14	13	12	11	10	9	8	7	6	5	4	3	2	1	0
Name	Isochronous receive context match															
Type	R/W	R/W	R/W	R/W	R/W	R/W	R/W	R/W	R	R/W	R/W	R/W	R/W	R/W	R/W	R/W
Default	X	X	X	X	X	X	X	X	0	X	X	X	X	X	X	X

Register: **Isochronous receive context match**
 Offset: 410Ch + (32 x *n*)
 Type: Read/Write, Read-Only
 Default: XXXX XXXXh

Table 4–35. Isochronous Receive Context Match Register Description

BIT	FIELD NAME	TYPE	DESCRIPTION
31	tag3	R/W	If bit 31 is set to 1, this context matches on isochronous receive packets with a tag field of 11b.
30	tag2	R/W	If bit 30 is set to 1, this context matches on isochronous receive packets with a tag field of 10b.
29	tag1	R/W	If bit 29 is set to 1, this context matches on isochronous receive packets with a tag field of 01b.
28	tag0	R/W	If bit 28 is set to 1, this context matches on isochronous receive packets with a tag field of 00b.
27	RSVD	R	Reserved. Bit 27 returns 0 when read.
26–12	cycleMatch	R/W	This field contains a 15-bit value corresponding to the two low-order bits of cycleSeconds and the 13-bit cycleCount field in the cycleStart packet. If cycleMatchEnable (bit 29) in the isochronous receive context control register (see Section 4.44, <i>Isochronous Receive Context Control Register</i>) is set to 1, this context is enabled for receives when the two low-order bits of the isochronous cycle timer register at OHCI offset F0h (see Section 4.34, <i>Isochronous Cycle Timer Register</i>) cycleSeconds field (bits 31–25) and cycleCount field (bits 24–12) value equal this field (cycleMatch) value.
11–8	sync	R/W	This 4-bit field is compared to the sync field of each isochronous packet for this channel when the command descriptor w field is set to 11b.
7	RSVD	R	Reserved. Bit 7 returns 0 when read.
6	tag1SyncFilter	R/W	If bit 6 and bit 29 (tag1) are set to 1, packets with tag 01b are accepted into the context if the two most significant bits of the packet sync field are 00b. Packets with tag values other than 01b are filtered according to bit 28 (tag0), bit 30 (tag2), and bit 31 (tag3) without any additional restrictions. If this bit is cleared, this context matches on isochronous receive packets as specified in bits 28–31 (tag0–tag3) with no additional restrictions.
5–0	channelNumber	R/W	This 6-bit field indicates the isochronous channel number for which this isochronous receive DMA context accepts packets.

5 TI Extension Registers

The TI extension base address register provides a method of accessing memory-mapped TI extension registers. See section 3.10, *TI Extension Base Address Register*, for register bit field details. See Table 5–1 for the TI extension register listing.

Table 5–1. TI Extension Register Map

REGISTER NAME	OFFSET
Reserved	00h–A7Fh
Isochronous Receive DV Enhancement Set	A80h
Isochronous Receive DV Enhancement Clear	A84h
Link Enhancement Control Set	A88h
Link Enhancement Control Clear	A8Ch
Isochronous Transmit Context 0 Timestamp Offset	A90h
Isochronous Transmit Context 1 Timestamp Offset	A94h
Isochronous Transmit Context 2 Timestamp Offset	A98h
Isochronous Transmit Context 3 Timestamp Offset	A9Ch
Isochronous Transmit Context 4 Timestamp Offset	AA0h
Isochronous Transmit Context 5 Timestamp Offset	AA4h
Isochronous Transmit Context 6 Timestamp Offset	AA8h
Isochronous Transmit Context 7 Timestamp Offset	AA8h

5.1 DV and MPEG2 Timestamp Enhancements

The DV timestamp enhancements are enabled by bit 8 (`enab_dv_ts`) in the link enhancement control register located at PCI offset F4h and are aliased in TI extension register space at offset A88h (set) and A8Ch (clear).

The DV and MPEG transmit enhancements are enabled separately by bits in the link enhancement control register located in PCI configuration space at PCI offset F4h. The link enhancement control register is also aliased as a set/clear register in TI extension space at offset A88h (set) and A8Ch (clear).

Bit 8 (`enab_dv_ts`) of the link enhancement control register enables DV timestamp support. When enabled, the link calculates a timestamp based on the cycle timer and the timestamp offset register and substitutes it in the SYT field of the CIP once per DV frame.

Bit 10 (`enab_mpeg_ts`) of the link enhancement control register enables MPEG timestamp support. Two MPEG timestamp modes are supported. The default mode calculates an initial delta that is added to the calculated timestamp in addition to a user-defined offset. The initial offset is calculated as the difference in the intended transmit cycle count and the cycle count field of the timestamp in the first TSP of the MPEG2 stream. The use of the initial delta can be controlled by bit 31 (`DisableInitialOffset`) in the timestamp offset register (see Section 5.5, *Timestamp Offset Register*).

The MPEG2 timestamp enhancements are enabled by bit 10 (`enab_mpeg_ts`) in the link enhancement control register located at PCI offset F4h and aliased in TI extension register space at offset A88h (set) and A8Ch (clear).

When bit 10 (`enab_mpeg_ts`) is set to 1, the hardware applies the timestamp enhancements to isochronous transmit packets that have the tag field equal to 01b in the isochronous packet header and a FMT field equal to 10h.

5.2 Isochronous Receive Digital Video Enhancements

The DV frame synchronous and branch enhancement provides a mechanism in buffer-fill mode to synchronize 1394 DV data that is received in the correct order to DV frame-sized data buffers described by several INPUT_MORE descriptors (see *1394 Open Host Controller Interface Specification*, Revision 1.1). This is accomplished by waiting for the start-of-frame packet in a DV stream before transferring the received isochronous stream into the memory buffer described by the INPUT_MORE descriptors. This can improve the DV capture application performance by reducing the amount of processing overhead required to strip the CIP header and copy the received packets into frame-sized buffers.

The start of a DV frame is represented in the 1394 packet as a 16-bit pattern of 1FX7h (first byte 1Fh and second byte X7h) received as the first two bytes of the third quadlet in a DV isochronous packet.

5.3 Isochronous Receive Digital Video Enhancements Register

The isochronous receive digital video enhancements register enables the DV enhancements in the TSB43AB21A device. The bits in this register may only be modified when both the active (bit 10) and run (bit 15) bits of the corresponding context control register are 0. See Table 5–2 for a complete description of the register contents.

Bit	31	30	29	28	27	26	25	24	23	22	21	20	19	18	17	16
Name	Isochronous receive digital video enhancements															
Type	R	R	R	R	R	R	R	R	R	R	R	R	R	R	R	R
Default	0	0	0	0	0	0	0	0	0	0	0	0	0	0	0	0
Bit	15	14	13	12	11	10	9	8	7	6	5	4	3	2	1	0
Name	Isochronous receive digital video enhancements															
Type	R	R	RSC	RSC	R	R	RSC	RSC	R	R	RSC	RSC	R	R	RSC	RSC
Default	0	0	0	0	0	0	0	0	0	0	0	0	0	0	0	0

Register: **Isochronous receive digital video enhancements**
 Offset: A80h set register
 A84h clear register
 Type: Read/Set/Clear, Read-Only
 Default: 0000 0000h

Table 5–2. Isochronous Receive Digital Video Enhancements Register Description

BIT	FIELD NAME	TYPE	DESCRIPTION
31–14	RSVD	R	Reserved. Bits 31–14 return 0s when read.
13	DV_Branch3	RSC	When bit 13 is set to 1, the isochronous receive context 3 synchronizes reception to the DV frame start tag in bufferfill mode if input_more.b = 01b, and jumps to the descriptor pointed to by frameBranch if a DV frame start tag is received out of place. This bit is only interpreted when bit 12 (CIP_Strip3) is set to 1 and bit 30 (isochHeader) in the isochronous receive context control register at OHCI offset 460h/464h (see Section 4.44, <i>Isochronous Receive Context Control Register</i>) is cleared to 0.
12	CIP_Strip3	RSC	When bit 12 is set to 1, the isochronous receive context 3 strips the first two quadlets of payload. This bit is only interpreted when bit 30 (isochHeader) in the isochronous receive context control register at OHCI offset 460h/464h (see Section 4.44, <i>Isochronous Receive Context Control Register</i>) is cleared to 0.
11–10	RSVD	R	Reserved. Bits 11 and 10 return 0s when read.
9	DV_Branch2	RSC	When bit 9 is set to 1, the isochronous receive context 2 synchronizes reception to the DV frame start tag in bufferfill mode if input_more.b = 01b, and jumps to the descriptor pointed to by frameBranch if a DV frame start tag is received out of place. This bit is only interpreted when bit 8 (CIP_Strip2) is set to 1 and bit 30 (isochHeader) in the isochronous receive context control register at OHCI offset 440h/444h (see Section 4.44, <i>Isochronous Receive Context Control Register</i>) is cleared to 0.

Table 5–2. Isochronous Receive Digital Video Enhancements Register Description (Continued)

BIT	FIELD NAME	TYPE	DESCRIPTION
8	CIP_Strip2	RSC	When bit 8 is set to 1, the isochronous receive context 2 strips the first two quadlets of payload. This bit is only interpreted when bit 30 (isochHeader) in the isochronous receive context control register at OHCI offset 440h/444h (see Section 4.44, <i>Isochronous Receive Context Control Register</i>) is cleared to 0.
7–6	RSVD	R	Reserved. Bits 7 and 6 return 0s when read.
5	DV_Branch1	RSC	When bit 5 is set to 1, the isochronous receive context 1 synchronizes reception to the DV frame start tag in bufferfill mode if input_more.b = 01b, and jumps to the descriptor pointed to by frameBranch if a DV frame start tag is received out of place. This bit is only interpreted when bit 4 (CIP_Strip1) is set to 1 and bit 30 (isochHeader) in the isochronous receive context control register at OHCI offset 420h/424h (see Section 4.44, <i>Isochronous Receive Context Control Register</i>) is cleared to 0.
4	CIP_Strip1	RSC	When bit 4 is set to 1, the isochronous receive context 1 strips the first two quadlets of payload. This bit is only interpreted when bit 30 (isochHeader) in the isochronous receive context control register at OHCI offset 420h/424h (see Section 4.44, <i>Isochronous Receive Context Control Register</i>) is cleared to 0.
3–2	RSVD	R	Reserved. Bits 3 and 2 return 0s when read.
1	DV_Branch0	RSC	When bit 1 is set to 1, the isochronous receive context 0 synchronizes reception to the DV frame start tag in bufferfill mode if input_more.b = 01b and jumps to the descriptor pointed to by frameBranch if a DV frame start tag is received out of place. This bit is only interpreted when bit 0 (CIP_Strip0) is set to 1 and bit 30 (isochHeader) in the isochronous receive context control register at OHCI offset 400h/404h (see Section 4.44, <i>Isochronous Receive Context Control Register</i>) is cleared to 0.
0	CIP_Strip0	RSC	When bit 0 is set to 1, the isochronous receive context 0 strips the first two quadlets of payload. This bit is only interpreted when bit 30 (isochHeader) in the isochronous receive context control register at OHCI offset 400h/404h (see Section 4.44, <i>Isochronous Receive Context Control Register</i>) is cleared to 0.

5.4 Link Enhancement Register

This register is a memory-mapped set/clear register that is an alias of the link enhancement control register at PCI offset F4h. These bits may be initialized by software. Some of the bits may also be initialized by a serial EEPROM, if one is present, as noted in the bit descriptions below. If the bits are to be initialized by software, the bits must be initialized prior to setting bit 19 (LPS) in the host controller control register at OHCI offset 50h/54h (see Section 4.16, *Host Controller Control Register*). See Table 5–3 for a complete description of the register contents.

Bit	31	30	29	28	27	26	25	24	23	22	21	20	19	18	17	16
Name	Link enhancement															
Type	R	R	R	R	R	R	R	R	R	R	R	R	R	R	R	R
Default	0	0	0	0	0	0	0	0	0	0	0	0	0	0	0	0
Bit	15	14	13	12	11	10	9	8	7	6	5	4	3	2	1	0
Name	Link enhancement															
Type	RSC	R	RSC	RSC	R	RSC	R	RSC	RSC	R	R	R	R	R	RSC	R
Default	0	0	0	1	0	0	0	0	0	0	0	0	0	0	0	0

Register: **Link enhancement**
 Offset: A88h set register
 A8Ch clear register
 Type: Read/Set/Clear, Read-Only
 Default: 0000 0000h

Table 5–3. Link Enhancement Register Description

BIT	FIELD NAME	TYPE	DESCRIPTION
31–16	RSVD	R	Reserved. Bits 31–16 return 0s when read.
15	dis_at_pipeline	RSC	Disable AT pipelining. When bit 15 is set to 1, out-of-order AT pipelining is disabled.
14	RSVD	R	Reserved.
13–12	atx_thresh	RSC	<p>This field sets the initial AT threshold value, which is used until the AT FIFO is underrun. When the TSB43AB21A device retries the packet, it uses a 2K-byte threshold, resulting in a store-and-forward operation.</p> <p>00 = Threshold ~ 2K bytes resulting in a store-and-forward operation 01 = Threshold ~ 1.7K bytes (default) 10 = Threshold ~ 1K bytes 11 = Threshold ~ 512 bytes</p> <p>These bits fine-tune the asynchronous transmit threshold. For most applications the 1.7K-byte threshold is optimal. Changing this value may increase or decrease the 1394 latency depending on the average PCI bus latency.</p> <p>Setting the AT threshold to 1.7K, 1K, or 512 bytes results in data being transmitted at these thresholds or when an entire packet has been checked into the FIFO. If the packet to be transmitted is larger than the AT threshold, the remaining data must be received before the AT FIFO is emptied; otherwise, an underrun condition occurs, resulting in a packet error at the receiving node. As a result, the link then commences store-and-forward operation. Wait until it has the complete packet in the FIFO before retransmitting it on the second attempt, to ensure delivery.</p> <p>An AT threshold of 2K results in store-and-forward operation, which means that asynchronous data will not be transmitted until an end-of-packet token is received. Restated, setting the AT threshold to 2K results in only complete packets being transmitted.</p> <p>Note that this device always uses store-and-forward when the asynchronous transmit retries register at OHCI offset 08h (see Section 4.3, <i>Asynchronous Transmit Retries Register</i>) is cleared.</p>
11	RSVD	R	Reserved. Bit 11 returns 0 when read.
10	enab_mpeg_ts	RSC	Enable MPEG timestamp enhancements. When bit 10 is set to 1, the enhancement is enabled for MPEG transmit streams (FMT = 20h).
9	RSVD	R	Reserved. Bit 9 returns 0 when read.
8	enab_dv_ts	RSC	Enable DV CIP timestamp enhancement. When bit 8 is set to 1, the enhancement is enabled for DV CIP transmit streams (FMT = 00h).

Table 5–3. Link Enhancement Register Description (Continued)

7	enab_unfair	RSC	Enable asynchronous priority requests. iOHCI-Lynx™ compatible. Setting bit 7 to 1 enables the link to respond to requests with priority arbitration. It is recommended that this bit be set to 1.
6	RSVD	R	This bit is not assigned in the TSB43AB21A follow-on products, since this bit location loaded by the serial EEPROM from the enhancements field corresponds to bit 23 (programPhyEnable) in the host controller control register at OHCI offset 50h/54h (see Section 4.16, <i>Host Controller Control Register</i>).
5–2	RSVD	R	Reserved. Bits 5–2 return 0s when read.
1	enab_accel	RSC	Enable acceleration enhancements. iOHCI-Lynx™ compatible. When bit 1 is set to 1, the PHY layer is notified that the link supports the IEEE Std 1394a-2000 acceleration enhancements, that is, ack-accelerated, fly-by concatenation, etc. It is recommended that this bit be set to 1.
0	RSVD	R	Reserved. Bit 0 returns 0 when read.

5.5 Timestamp Offset Register

The value of this register is added as an offset to the cycle timer value when using the MPEG, DV, and CIP enhancements. A timestamp offset register is implemented per isochronous transmit context. The n value following the offset indicates the context number (n = 0, 1, 2, 3, ..., 7). These registers are programmed by software as appropriate. See Table 5–4 for a complete description of the register contents.

Bit	31	30	29	28	27	26	25	24	23	22	21	20	19	18	17	16
Name	Timestamp offset															
Type	R/W	R	R	R	R	R	R	R/W	R/W	R/W	R/W	R/W	R/W	R/W	R/W	R/W
Default	0	0	0	0	0	0	0	0	0	0	0	0	0	0	0	0
Bit	15	14	13	12	11	10	9	8	7	6	5	4	3	2	1	0
Name	Timestamp offset															
Type	R/W	R/W	R/W	R/W	R/W	R/W	R/W	R/W	R/W	R/W	R/W	R/W	R/W	R/W	R/W	R/W
Default	0	0	0	0	0	0	0	0	0	0	0	0	0	0	0	0

Register: **Timestamp offset**
 Offset: A90h + (4 x n)
 Type: Read/Write, Read-Only
 Default: 0000 0000h

Table 5–4. Timestamp Offset Register Description

BIT	FIELD NAME	TYPE	DESCRIPTION
31	DisableInitialOffset	R/W	Bit 31 disables the use of the initial timestamp offset when the MPEG2 enhancements are enabled. A value of 0 indicates the use of the initial offset, a value of 1 indicates that the initial offset must not be applied to the calculated timestamp. This bit has no meaning for the DV timestamp enhancements.
30–25	RSVD	R	Reserved. Bits 30–25 return 0s when read.
24–12	CycleCount	R/W	This field adds an offset to the cycle count field in the timestamp when the DV or MPEG2 enhancements are enabled. The cycle count field is incremented modulo 8000; therefore, values in this field must be limited between 0 and 7999.
11–0	CycleOffset	R/W	This field adds an offset to the cycle offset field in the timestamp when the DV or MPEG2 enhancements are enabled. The cycle offset field is incremented modulo 3072; therefore, values in this field must be limited between 0 and 3071.

6 Serial EEPROM Interface

The TSB43AB21A device provides a serial bus interface to initialize the GUID registers and a few PCI configuration registers through a serial EEPROM. The TSB43AB21A device communicates with the serial EEPROM via the 2-wire serial interface.

After power up the serial interface initializes the locations listed in Table 6–1. While the TSB43AB21A device accesses the serial EEPROM, all incoming PCI slave accesses are terminated with retry status. Table 6–2 shows the serial EEPROM memory map required for initializing the TSB43AB21A registers.

NOTE: If an EEPROM is implemented in the design, byte offsets 00h–16h must be programmed. An unprogrammed EEPROM defaults to all 1s, which can adversely impact device operation.

Table 6–1. Registers and Bits Loadable Through Serial EEPROM

EEPROM BYTE OFFSET	OHCI/PCI CONFIGURATION OFFSET	REGISTER NAME	REGISTER BITS LOADED FROM EEPROM
00h	PCI register (3Eh)	PCI maximum latency, PCI minimum grant	15–0
01h	PCI register (2Dh)	Vendor identification	15–0
03h	PCI register (2Ch)	Subsystem identification	15–0
05h (bit 6)	OHCI register (50h)	Host controller control	23
05h	PCI register (F4h)	Link enhancement control	7, 6, 1
06h	OHCI register (04h)	GUID ROM	7–0
07h–0Ah	OHCI register (24h)	GUID high	31–0
0Bh–0Eh	OHCI register (28h)	GUID low	31–0
10h	PCI register (F4h)	Link enhancement control	15–12
11h–12h	PCI register (F0h)	Miscellaneous configuration†	15, 4
14h	PCI register (28h)	CardBus CIS pointer	7–3
16h	PCI register (ECh)	PCI PHY control‡	7–0

† Bits 2–0 at EEPROM byte offset 11h must be programmed to 000b to ensure proper functioning. By default, unprogrammed EEPROM bits are 1.

‡ Bits 6–4 and 2–0 at EEPROM byte offset 16h must be programmed to 0 to ensure proper functioning. Bit 3 must be programmed to 1. If CNA functionality is desired on terminal 96, bit 7 must be programmed to 1; otherwise, bit 7 can be programmed to 0.

Table 6–2. Serial EEPROM Map

EEPROM BYTE ADDRESS	BYTE DESCRIPTION					
00	PCI maximum latency (0h)			PCI_minimum grant (0h)		
01	PCI vendor ID					
02	PCI vendor ID (msbyte)					
03	PCI subsystem ID (lsbyte)					
04	PCI subsystem ID (msbyte)					
05	[7] Link_enhancement Control.enab_unfair	[6] HCControl. ProgramPhy Enable	[5–3] RSVD	[2] RSVD†	[1] Link_enhancement Control.enab_accel	[0] RSVD
06	[7–6] RSVD	Mini ROM address	[4–3] RSVD			
07	GUID high (lsbyte 0)					
08	GUID high (byte 1)					
09	GUID high (byte 2)					
0A	GUID high (msbyte 3)					
0B	GUID low (lsbyte 0)					
0C	GUID low (byte 1)					
0D	GUID low (byte 2)					
0E	GUID low (msbyte 3)					
0F	Checksum					
10‡	[15] dis_at_pipeline	[14] RSVD	[13–12] ATX threshold	[11–8] RSVD		
11§	[7–5] RSVD		[4] Disable Target Abort	[3–0] RSVD		
12	[15] PME D3 Cold	[14–8] RSVD				
13	[7–0] RSVD					
14	[7–3] CIS_offset			[2–0] RSVD		
15	RSVD					
16¶	[7] CNA OUT Enable	[6–4] RSVD	[3] RSVD	[2–0] RSVD		
17–1F	RSVD					

† Bit 2 at EEPROM byte offset 05h must be programmed to 0b.

‡ Bit 14 must be programmed to 0 for normal operation.

§ Bits 2–0 at EEPROM byte offset 11h must be programmed to 000b to ensure proper functioning. By default, unprogrammed EEPROM bits are 1.

¶ Bits 6–4 and 2–0 at EEPROM byte offset 16h must be programmed to 0 to ensure proper functioning. Bit 3 must be programmed to 1. If CNA functionality is desired on terminal 96, bit 7 must be programmed to 1; otherwise, bit 7 can be programmed to 0.

7 PHY Register Configuration

There are 16 accessible internal registers in the TSB43AB21A device. The configuration of the registers at addresses 0h through 7h (the base registers) is fixed, whereas the configuration of the registers at addresses 8h through Fh (the paged registers) is dependent upon which one of eight pages, numbered 0h through 7h, is currently selected. The selected page is set in base register 7h.

7.1 Base Registers

Table 7–1 shows the configuration of the base registers, and Table 7–2 shows the corresponding field descriptions. The base register field definitions are unaffected by the selected page number.

A reserved register or register field (marked as Reserved in the following register configuration tables) is read as 0, but is subject to future usage. All registers in address pages 2 through 6 are reserved.

Table 7–1. Base Register Configuration

ADDRESS	BIT POSITION							
	0	1	2	3	4	5	6	7
0000	Physical ID						R	CPS
0001	RHB	IBR	Gap_Count					
0010	Extended (111b)			Reserved	Total_Ports (0001b)			
0011	Max_Speed (010b)			Reserved	Delay (0000b)			
0100	LCtrl	C	Jitter (000b)			Pwr_Class		
0101	Watchdog	ISBR	Loop	Pwr_fail	Timeout	Port_event	Enab_accel	Enab_multi
0110	Reserved							
0111	Page_Select			Reserved	Port_Select			

Table 7–2. Base Register Field Descriptions

FIELD	SIZE	TYPE	DESCRIPTION
Physical ID	6	R	This field contains the physical address ID of this node determined during self-ID. The physical ID is invalid after a bus reset until self-ID has completed as indicated by an unsolicited register-0 status transfer.
R	1	R	Root. This bit indicates that this node is the root node. The R bit is cleared to 0 by bus reset and is set to 1 during tree-ID if this node becomes root.
CPS	1	R	Cable-power-status. This bit indicates the state of the CPS input terminal. The CPS terminal is normally tied to serial bus cable power through a 400-kΩ resistor. A 0 in this bit indicates that the cable power voltage has dropped below its threshold for ensured reliable operation.
RHB	1	R/W	Root-holdoff bit. This bit instructs the PHY layer to attempt to become root after the next bus reset. The RHB bit is cleared to 0 by a system (hardware) reset and is unaffected by a bus reset.
IBR	1	R/W	Initiate bus reset. This bit instructs the PHY layer to initiate a long (166 μs) bus reset at the next opportunity. Any receive or transmit operation in progress when this bit is set will complete before the bus reset is initiated. The IBR bit is cleared to 0 after a system (hardware) reset or a bus reset.
Gap_Count	6	R/W	Arbitration gap count. This value sets the subaction (fair) gap, arb-reset gap, and arb-delay times. The gap count can be set either by a write to the register, or by reception or transmission of a PHY_CONFIG packet. The gap count is reset to 3Fh by system (hardware) reset or after two consecutive bus resets without an intervening write to the gap count register (either by a write to the PHY register or by a PHY_CONFIG packet).
Extended	3	R	Extended register definition. For the TSB43AB21A device, this field is 111b, indicating that the extended register set is implemented.
Total_Ports	4	R	Number of ports. This field indicates the number of ports implemented in the PHY layer. For the TSB43AB21A device this field is 1.
Max_Speed	3	R	PHY speed capability. For the TSB43AB21A PHY layer this field is 010b, indicating S400 speed capability.
Delay	4	R	PHY repeater data delay. This field indicates the worst case repeater data delay of the PHY layer, expressed as $144 + (\text{delay} \times 20)$ ns. For the TSB43AB21A device this field is 0.
LCtrl	1	R/W	Link-active status control. This bit controls the active status of the LLC as indicated during self-ID. The logical AND of this bit and the LPS active status is replicated in the L field (bit 9) of the self-ID packet. The LLC is considered active only if both the LPS input is active and the LCtrl bit is set. The LCtrl bit provides a software controllable means to indicate the LLC active/status in lieu of using the LPS input. The LCtrl bit is set to 1 by a system (hardware) reset and is unaffected by a bus reset. NOTE: The state of the PHY-LLC interface is controlled solely by the LPS input, regardless of the state of the LCtrl bit. If the PHY-LLC interface is operational as determined by the LPS input being active, received packets and status information continue to be presented on the interface, and any requests indicated on the LREQ input are processed, even if the LCtrl bit is cleared to 0.
C	1	R/W	Contender status. This bit indicates that this node is a contender for the bus or isochronous resource manager. This bit is replicated in the c field (bit 20) of the self-ID packet.
Jitter	3	R	PHY repeater jitter. This field indicates the worst case difference between the fastest and slowest repeater data delay, expressed as $(\text{Jitter} + 1) \times 20$ ns. For the TSB43AB21A device, this field is 0.
Pwr_Class	3	R/W	Node power class. This field indicates this node power consumption and source characteristics and is replicated in the pwr field (bits 21–23) of the self-ID packet. This field is reset to the state specified by the PC0–PC2 input terminals upon a system (hardware) reset and is unaffected by a bus reset. See Table 7–9.
Watchdog	1	R/W	Watchdog enable. This bit, if set to 1, enables the port event interrupt (Port_event) bit to be set whenever resume operations begin on the port. This bit is cleared to 0 by system (hardware) reset and is unaffected by bus reset.

Table 7–2. Base Register Field Descriptions (Continued)

FIELD	SIZE	TYPE	DESCRIPTION
ISBR	1	R/W	Initiate short arbitrated bus reset. This bit, if set to 1, instructs the PHY layer to initiate a short (1.3 μ s) arbitrated bus reset at the next opportunity. This bit is cleared to 0 by a bus reset. NOTE: Legacy IEEE Std 1394-1995 compliant PHY layers can not be capable of performing short bus resets. Therefore, initiation of a short bus reset in a network that contains such a legacy device results in a long bus reset being performed.
Loop	1	R/W	Loop detect. This bit is set to 1 when the arbitration controller times out during tree-ID start and may indicate that the bus is configured in a loop. This bit is cleared to 0 by system (hardware) reset or by writing a 1 to this register bit. If the Loop and Watchdog bits are both set and the LLC is or becomes inactive, the PHY layer activates the LLC to service the interrupt. NOTE: If the network is configured in a loop, only those nodes which are part of the loop generate a configuration-timeout interrupt. All other nodes instead time out waiting for the tree-ID and/or self-ID process to complete and then generate a state time-out interrupt and bus-reset.
Pwr_fail	1	R/W	Cable power failure detect. This bit is set to 1 whenever the CPS input transitions from high to low indicating that cable power may be too low for reliable operation. This bit is cleared to 0 by system (hardware) reset or by writing a 1 to this register bit.
Timeout	1	R/W	State time-out interrupt. This bit indicates that a state time-out has occurred (which also causes a bus reset to occur). This bit is cleared to 0 by system (hardware) reset or by writing a 1 to this register bit.
Port_event	1	R/W	Port event detect. This bit is set to 1 upon a change in the bias (unless disabled) connected, disabled, or fault bits for the port if the port interrupt enable (Int_enable) bit is set. Additionally, if the Watchdog bit is set, the Port_event bit is set to 1 at the start of resume operations on the port. This bit is cleared to 0 by system (hardware) reset or by writing a 1 to this register bit.
Enab_accel	1	R/W	Enable accelerated arbitration. This bit enables the PHY layer to perform the various arbitration acceleration enhancements defined in IEEE Std 1394a-2000 (ACK-accelerated arbitration, asynchronous fly-by concatenation, and isochronous fly-by concatenation). This bit is cleared to 0 by system (hardware) reset and is unaffected by bus reset.
Enab_multi	1	R/W	Enable multispeed concatenated packets. This bit enables the PHY layer to transmit concatenated packets of differing speeds in accordance with the protocols defined in IEEE Std 1394a-2000. This bit is cleared to 0 by system (hardware) reset and is unaffected by bus reset.
Page_Select	3	R/W	Page_Select. This field selects the register page to use when accessing register addresses 8 through 15. This field is cleared to 0 by a system (hardware) reset and is unaffected by bus reset.
Port_Select	4	R/W	Port_Select. This field selects the port when accessing per-port status or control (for example, when one of the port status/control registers is accessed in page 0). Ports are numbered starting at 0. This field is cleared to 0 by system (hardware) reset and is unaffected by bus reset. If the Port_Select field is programmed to a value that is not supported (for example, the TSB43AB21A device only supports port 0), all registers in the port status page read 0.

7.2 Port Status Register

The port status page provides access to configuration and status information for the port. The port is selected by writing 0 to the Page_Select field and to the Port_Select field in base register 7. Table 7–3 shows the configuration of the port status page registers and Table 7–4 shows the corresponding field descriptions. If the selected port is not implemented, all registers in the port status page are read as 0.

Table 7–3. Page 0 (Port Status) Register Configuration

ADDRESS	BIT POSITION							
	0	1	2	3	4	5	6	7
1000	AStat		BStat		Ch	Con	Bias	Dis
1001	Peer_Speed			Int_enable	Fault	Reserved		
1010	Reserved							
1011	Reserved							
1100	Reserved							
1101	Reserved							
1110	Reserved							
1111	Reserved							

Table 7–4. Page 0 (Port Status) Register Field Descriptions

FIELD	SIZE	TYPE	DESCRIPTION										
AStat	2	R	TPA line state. This field indicates the TPA line state of the selected port, encoded as follows: <table border="0"> <tr> <td><u>Code</u></td> <td><u>Arb Value</u></td> </tr> <tr> <td>11</td> <td>Z</td> </tr> <tr> <td>10</td> <td>0</td> </tr> <tr> <td>01</td> <td>1</td> </tr> <tr> <td>00</td> <td>invalid</td> </tr> </table>	<u>Code</u>	<u>Arb Value</u>	11	Z	10	0	01	1	00	invalid
<u>Code</u>	<u>Arb Value</u>												
11	Z												
10	0												
01	1												
00	invalid												
BStat	2	R	TPB line state. This field indicates the TPB line state of the selected port. This field has the same encoding as the AStat field.										
Ch	1	R	Child/parent status. A 1 indicates that the selected port is a child port. A 0 indicates that the selected port is the parent port. A disconnected, disabled, or suspended port is reported as a child port. The Ch bit is invalid after a bus reset until tree-ID has completed.										
Con	1	R	Debounced port connection status. This bit indicates that the selected port is connected. The connection must be stable for the debounce time of approximately 341 ms for the Con bit to be set to 1. The Con bit is cleared to 0 by system (hardware) reset and is unaffected by bus reset. NOTE: The Con bit indicates that the port is physically connected to a peer PHY device, but the port is not necessarily active.										
Bias	1	R	Debounced incoming cable bias status. A 1 indicates that the selected port is detecting incoming cable bias. The incoming cable bias must be stable for the debounce time of 52 μs for the Bias bit to be set to 1.										
Dis	1	R/W	Port disabled control. If the Dis bit is set to 1, the selected port is disabled. The Dis bit is cleared to 0 by system (hardware) reset (all ports are enabled for normal operation following system (hardware) reset). The Dis bit is not affected by bus reset.										
Peer_Speed	3	R	Port peer speed. This field indicates the highest speed capability of the peer PHY device connected to the selected port, encoded as follows: <table border="0"> <tr> <td><u>Code</u></td> <td><u>Peer Speed</u></td> </tr> <tr> <td>000</td> <td>S100</td> </tr> <tr> <td>001</td> <td>S200</td> </tr> <tr> <td>010</td> <td>S400</td> </tr> <tr> <td>011–111</td> <td>invalid</td> </tr> </table> The Peer_Speed field is invalid after a bus reset until self-ID has completed. NOTE: Peer speed codes higher than 010b (S400) are defined in IEEE Std 1394a-2000. However, the TSB43AB21A device is only capable of detecting peer speeds up to S400.	<u>Code</u>	<u>Peer Speed</u>	000	S100	001	S200	010	S400	011–111	invalid
<u>Code</u>	<u>Peer Speed</u>												
000	S100												
001	S200												
010	S400												
011–111	invalid												

Table 7–4. Page 0 (Port Status) Register Field Descriptions (Continued)

FIELD	SIZE	TYPE	DESCRIPTION
Int_enable	1	R/W	Port event interrupt enable. When the Int_enable bit is set to 1, a port event on the selected port sets the port event interrupt (Port_event) bit and notifies the link. This bit is cleared to 0 by a system (hardware) reset and is unaffected by bus reset.
Fault	1	R/W	Fault. This bit indicates that a resume-fault or suspend-fault has occurred on the selected port, and that the port is in the suspended state. A resume-fault occurs when a resuming port fails to detect incoming cable bias from its attached peer. A suspend-fault occurs when a suspending port continues to detect incoming cable bias from its attached peer. Writing 1 to this bit clears the fault bit to 0. This bit is cleared to 0 by system (hardware) reset and is unaffected by bus reset.

7.3 Vendor Identification Register

The vendor identification page identifies the vendor/manufacturer and compliance level. The page is selected by writing 1 to the Page_Select field in base register 7. Table 7–5 shows the configuration of the vendor identification page, and Table 7–6 shows the corresponding field descriptions.

Table 7–5. Page 1 (Vendor ID) Register Configuration

ADDRESS	BIT POSITION							
	0	1	2	3	4	5	6	7
1000	Compliance							
1001	Reserved							
1010	Vendor_ID[0]							
1011	Vendor_ID[1]							
1100	Vendor_ID[2]							
1101	Product_ID[0]							
1110	Product_ID[1]							
1111	Product_ID[2]							

Table 7–6. Page 1 (Vendor ID) Register Field Descriptions

FIELD	SIZE	TYPE	DESCRIPTION
Compliance	8	R	Compliance level. For the TSB43AB21A device this field is 01h, indicating compliance with IEEE Std 1394a-2000.
Vendor_ID	24	R	Manufacturer's organizationally unique identifier (OUI). For the TSB43AB21A device this field is 08 0028h (Texas Instruments) (the MSB is at register address 1010b).
Product_ID	24	R	Product identifier. For the TSB43AB21A device this field is 42 4499h (the MSB is at register address 1101b).

7.4 Vendor-Dependent Register

The vendor-dependent page provides access to the special control features of the TSB43AB21A device, as well as to configuration and status information used in manufacturing test and debug. This page is selected by writing 7 to the Page_Select field in base register 7. Table 7–7 shows the configuration of the vendor-dependent page, and Table 7–8 shows the corresponding field descriptions.

Table 7–7. Page 7 (Vendor-Dependent) Register Configuration

ADDRESS	BIT POSITION							
	0	1	2	3	4	5	6	7
1000	NPA	Reserved					Link_Speed	
1001	Reserved for test							
1010	Reserved for test							
1011	Reserved for test							
1100	Reserved for test							
1101	Reserved for test							
1110	Reserved for test							
1111	Reserved for test							

Table 7–8. Page 7 (Vendor-Dependent) Register Field Descriptions

FIELD	SIZE	TYPE	DESCRIPTION										
NPA	1	R/W	Null-packet actions flag. This bit instructs the PHY layer to not clear fair and priority requests when a null packet is received with arbitration acceleration enabled. If this bit is set to 1, fair and priority requests are cleared only when a packet of more than 8 bits is received; ACK packets (exactly 8 data bits), null packets (no data bits), and malformed packets (less than 8 data bits) do not clear fair and priority requests. If this bit is cleared to 0, fair and priority requests are cleared when any non-ACK packet is received, including null packets or malformed packets of less than 8 bits. This bit is cleared to 0 by system (hardware) reset and is unaffected by bus reset.										
Link_Speed	2	R/W	Link speed. This field indicates the top speed capability of the attached LLC. Encoding is as follows: <table style="margin-left: 20px; border: none;"> <tr> <td style="text-align: center;"><u>Code</u></td> <td style="text-align: center;"><u>Speed</u></td> </tr> <tr> <td style="text-align: center;">00</td> <td style="text-align: center;">S100</td> </tr> <tr> <td style="text-align: center;">01</td> <td style="text-align: center;">S200</td> </tr> <tr> <td style="text-align: center;">10</td> <td style="text-align: center;">S400</td> </tr> <tr> <td style="text-align: center;">11</td> <td style="text-align: center;">illegal</td> </tr> </table> <p>This field is replicated in the sp field of the self-ID packet to indicate the speed capability of the node (PHY and LLC in combination). However, this field does not affect the PHY speed capability indicated to peer PHYs during self-ID; the TSB43AB21A PHY layer identifies itself as S400 capable to its peers regardless of the value in this field. This field is set to 10b (S400) by system (hardware) reset and is unaffected by bus reset.</p>	<u>Code</u>	<u>Speed</u>	00	S100	01	S200	10	S400	11	illegal
<u>Code</u>	<u>Speed</u>												
00	S100												
01	S200												
10	S400												
11	illegal												

7.5 Power-Class Programming

The PC0–PC2 terminals are programmed to set the default value of the power-class indicated in the pwr field (bits 21–23) of the transmitted self-ID packet. Table 7–9 shows the descriptions of the various power classes. The default power-class value is loaded following a system (hardware) reset, but is overridden by any value subsequently loaded into the Pwr_Class field in register 4.

Table 7–9. Power Class Descriptions

PC0–PC2	DESCRIPTION
000	Node does not need power and does not repeat power.
001	Node is self-powered and provides a minimum of 15 W to the bus.
010	Node is self-powered and provides a minimum of 30 W to the bus.
011	Node is self-powered and provides a minimum of 45 W to the bus.
100	Node may be powered from the bus and is using up to 3 W. No additional power is needed to enable the link.
101	Reserved
110	Node is powered from the bus and uses up to 3 W. An additional 3 W is needed to enable the link.
111	Node is powered from the bus and uses up to 3 W. An additional 7 W is needed to enable the link.

8 Application Information

8.1 PHY Port Cable Connection

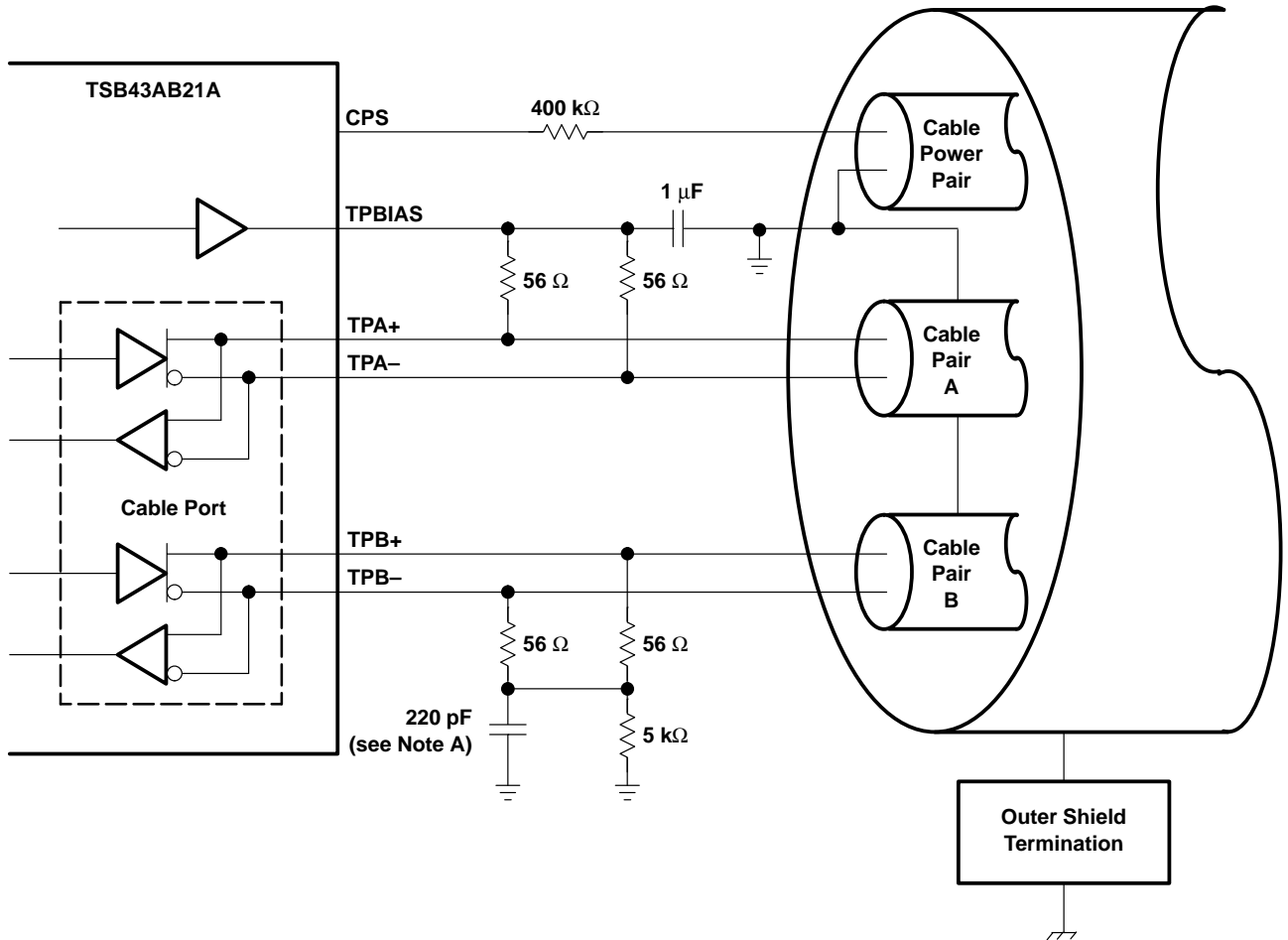

NOTE A: IEEE Std 1394-1995 calls for a 250-pF capacitor, which is a nonstandard component value. A 220-pF capacitor is recommended.

Figure 8–1. TP Cable Connections

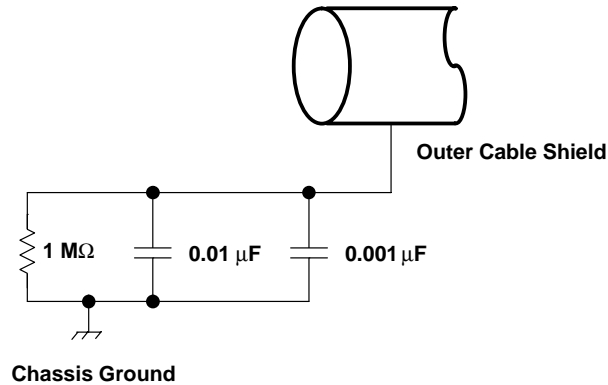

Figure 8–2. Typical Compliant DC Isolated Outer Shield Termination

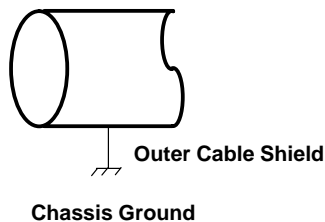

Figure 8–3. Non-DC Isolated Outer Shield Termination

8.2 Crystal Selection

The TSB43AB21A device is designed to use an external 24.576-MHz crystal connected between the XI and XO pins to provide the reference for an internal oscillator circuit. This oscillator in turn drives a PLL circuit that generates the various clocks required for transmission and resynchronization of data at the S100 through S400 media data rates.

A variation of less than ± 100 ppm from nominal for the media data rates is required by IEEE Std 1394-1995. Adjacent PHYs may therefore have a difference of up to 200 ppm from each other in their internal clocks, and PHY devices must be able to compensate for this difference over the maximum packet length. Large clock variations may cause resynchronization overflows or underflows, resulting in corrupted packet data.

The following are some typical specifications for crystals used with the PHYs from TI in order to achieve the required frequency accuracy and stability:

- Crystal mode of operation: Fundamental
- Frequency tolerance @ 25°C: Total frequency variation for the complete circuit is ± 100 ppm. A crystal with ± 30 ppm frequency tolerance is recommended for adequate margin.
- Frequency stability (over temperature and age): A crystal with ± 30 ppm frequency stability is recommended for adequate margin.

NOTE: The total frequency variation must be kept below ± 100 ppm from nominal with some allowance for error introduced by board and device variations. Trade-offs between frequency tolerance and stability may be made as long as the total frequency variation is less than ± 100 ppm. For example, the frequency tolerance of the crystal may be specified at 50 ppm and the temperature tolerance may be specified at 30 ppm to give a total of 80 ppm possible variation due to the crystal alone. Crystal aging also contributes to the frequency variation.

- Load capacitance: For parallel resonant mode crystal circuits, the frequency of oscillation is dependent upon the load capacitance specified for the crystal. Total load capacitance (C_L) is a function of not only the discrete load capacitors, but also board layout and circuit. It is recommended that load capacitors with a maximum of $\pm 5\%$ tolerance be used.

For example, load capacitors (C9 and C10 in Figure 8–4) of 16 pF each were appropriate for the layout of the TSB43AB21A evaluation module (EVM), which uses a crystal specified for 12-pF loading. The load specified for the crystal includes the load capacitors (C9 and C10), the loading of the PHY pins (C_{PHY}), and the loading of the board itself (C_{BD}). The value of C_{PHY} is typically about 1 pF, and C_{BD} is typically 0.8 pF per centimeter of board etch; a *typical* board can have 3 pF to 6 pF or more. The load capacitors C9 and C10 combine as capacitors in series so that the total load capacitance is:

$$C_L = \frac{C9 \times C10}{C9 + C10} + C_{PHY} + C_{BD}$$

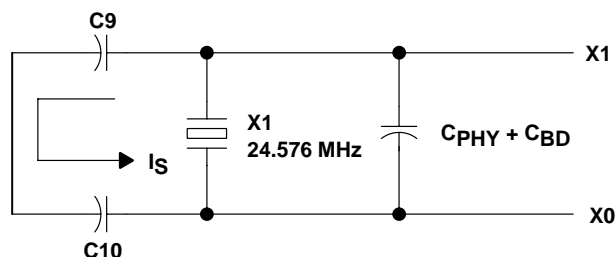
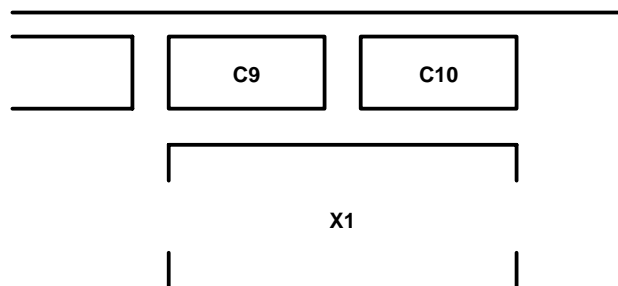

Figure 8–4. Load Capacitance for the TSB43AB21A PHY

The layout of the crystal portion of the PHY circuit is important for obtaining the correct frequency, minimizing noise introduced into the PHY phase-lock loop, and minimizing any emissions from the circuit. The crystal and two load capacitors must be considered as a unit during layout. The crystal and the load capacitors must be placed as close as possible to one another while minimizing the loop area created by the combination of the three components. Varying the size of the capacitors may help in this. Minimizing the loop area minimizes the effect of the resonant current (I_s) that flows in this resonant circuit. This layout unit (crystal and load capacitors) must then be placed as close as possible to the PHY X1 and X0 pins to minimize etch lengths, as shown in Figure 8–5.



For more details on crystal selection, see application report SLLA051 available from the TI website: <http://www.ti.com/sc/1394>.

Figure 8–5. Recommended Crystal and Capacitor Layout

8.3 Bus Reset

In the TSB43AB21A device, the initiate bus reset (IBR) bit may be set to 1 in order to initiate a bus reset and initialization sequence. The IBR bit is located in PHY register 1, along with the root-holdoff bit (RHB) and Gap_Count field, as required by IEEE Std 1394a-2000. Therefore, whenever the IBR bit is written, the RHB and Gap_Count are also written.

The RHB and Gap_Count may also be updated by PHY-config packets. The TSB43AB21A device is IEEE 1394a-2000 compliant, and therefore both the reception and transmission of PHY-config packets cause the RHB and Gap_Count to be loaded, unlike older IEEE 1394-1995 compliant PHY devices which decode only received PHY-config packets.

The gap-count is set to the maximum value of 63 after 2 consecutive bus resets without an intervening write to the Gap_Count, either by a write to PHY register 1 or by a PHY-config packet. This mechanism allows a PHY-config

packet to be transmitted and then a bus reset initiated so as to verify that all nodes on the bus have updated their RHBs and Gap_Count values, without having the Gap_Count set back to 63 by the bus reset. The subsequent connection of a new node to the bus, which initiates a bus reset, then causes the Gap_Count of each node to be set to 63. Note, however, that if a subsequent bus reset is instead initiated by a write to register 1 to set the IBR bit, all other nodes on the bus have their Gap_Count values set to 63, while this node Gap_Count remains set to the value just loaded by the write to PHY register 1.

Therefore, in order to maintain consistent gap-counts throughout the bus, the following rules apply to the use of the IBR bit, RHB, and Gap_Count in PHY register 1:

- Following the transmission of a PHY-config packet, a bus reset must be initiated in order to verify that all nodes have correctly updated their RHBs and Gap_Count values and to ensure that a subsequent new connection to the bus causes the Gap_Count to be set to 63 on all nodes in the bus. If this bus reset is initiated by setting the IBR bit to 1, the RHB and Gap_Count field must also be loaded with the correct values consistent with the just transmitted PHY-config packet. In the TSB43AB21A device, the RHB and Gap_Count are updated to their correct values upon the transmission of the PHY-config packet, so these values may first be read from register 1 and then rewritten.
- Other than to initiate the bus reset, which must follow the transmission of a PHY-config packet, whenever the IBR bit is set to 1 in order to initiate a bus reset, the Gap_Count value must also be set to 63 so as to be consistent with other nodes on the bus, and the RHB must be maintained with its current value.
- The PHY register 1 must not be written to except to set the IBR bit. The RHB and Gap_Count must not be written without also setting the IBR bit to 1.

8.4 EMI Guidelines

For electromagnetic interference (EMI) guidelines and recommendations send a request via e-mail to 1394-EMI@list.ti.com.

9 Electrical Characteristics

9.1 Absolute Maximum Ratings Over Operating Temperature Ranges†

Supply voltage range: REG18	-0.2 V to 2.2 V
AV _{DD}	-0.3 V to 4 V
DV _{DD}	-0.3 V to 4 V
PLL _{V_{DD}}	-0.3 V to 4 V
V _{DDP}	-0.5 V to 5.5 V
Input voltage range for PCI, V _I , PHY, and Miscellaneous	-0.5 to V _{DD} + 0.5 V
Output voltage range for PCI, V _O , PHY, and Miscellaneous	-0.5 to V _{DD} + 0.5 V
Input clamp current, I _{IK} (V _I < 0 or V _I > V _{DD}) (see Note 1)	±20 mA
Output clamp current, I _{OK} (V _O < 0 or V _O > V _{DD}) (see Note 2)	±20 mA
Electrostatic discharge (see Note 3)	HBM: 2 kV, MM: 200 V
Continuous total power dissipation	See Dissipation Rating Table
Operating free-air temperature, T _A : TSB43AB21A	0°C to 70°C
TSB43AB21AI	-40°C to 85°C
Storage temperature range, T _{stg}	-65°C to 150°C
Lead temperature 1,6 mm (1/16 inch) from cage for 10 seconds	260°C

† Stresses beyond those listed under absolute maximum ratings may cause permanent damage to the device. These are stress ratings only, and functional operation of the device at these or any other conditions beyond those indicated under recommended operating conditions is not implied. Exposure to absolute-maximum-rated conditions for extended periods may affect device reliability.

- NOTES:
1. Applies to external input and bidirectional buffers. For 5-V tolerant use V_I > V_{DDI}. For PCI use V_I > V_{DDP}.
 2. Applies to external output and bidirectional buffers. For 5-V tolerant use V_O > V_{DDI}. For PCI use V_O > V_{DDP}.
 3. HBM is human body model, MM is machine model.

DISSIPATION RATING TABLE

PACKAGE	T _A ≤ 25°C POWER RATING	DERATING FACTOR§ ABOVE T _A = 25°C	T _A = 70°C POWER RATING	T _A = 85°C POWER RATING
PDT‡	1.116 W	0.013 W/°C	0.563 W	0.336 W
PDT§	0.967 W	0.009 W/°C	0.523 W	0.427 W

‡ Standard JEDEC high-K board

§ Standard JEDEC low-K board

9.2 Recommended Operating Conditions

		TEST CONDITION	MIN	NOM	MAX	UNIT
REG18			1.6	1.8	2	V
Core voltage, AV _{DD}			3	3.3	3.6	V
Core voltage, DV _{DD}			3	3.3	3.6	V
Core voltage, PLLV _{DD}			2.7	3	3.6	V
Output voltage, V _O		TTL and LVCMOS terminals	0		DV _{DD}	V
PCI I/O clamping voltage, V _{DDP}		V _{DDP} = 3.3 V	3	3.3	3.6	V
		V _{DDP} = 5 V	4.5	5	5.5	
High-level input voltage, V _{IH} [†]		PCI	3.3 V	0.475DV _{DD}	DV _{DD}	V
			5 V	2	V _{DDP}	
		PC(0–2)		0.7DV _{DD}	DV _{DD}	
		$\overline{G_RST}$		0.6DV _{DD}	DV _{DD}	
		Miscellaneous [‡]	2	V _{DDP}		
Low-level input voltage, V _{IL} [†]		PCI	3.3 V	0	0.325DV _{DD}	V
			5 V	0	0.8	
		PC(0–2)		0	0.2DV _{DD}	
		$\overline{G_RST}$		0	0.3DV _{DD}	
			Miscellaneous [‡]	0	0.8	
Input voltage, V _I		PCI	3.3 V	0	DV _{DD}	V
			Miscellaneous [‡]	0	V _{DDP}	
Output voltage, V _O [§]		PCI	3.3 V	0	DV _{DD}	V
			Miscellaneous [‡]	0	DV _{DD}	
Input transition time (t _r and t _f), t _t		PCI		0	6	ns
Operating free-air temperature, T _A		R θ_{JA} = 70.82°C/W	T _A = 70°C		99.3	°C
			T _A = 85°C		110.5	°C
Output current, I _O		TPBIAS outputs		–5.6	1.3	mA
Differential input voltage, V _{ID}		Cable inputs, during data reception		118	260	mV
		Cable inputs, during arbitration		168	265	
Common-mode input voltage, V _{IC}		TPB cable inputs, source power node		0.4706	2.515	V
		TPB cable inputs, nonsource power node		0.4706	2.015 [¶]	
Maximum junction temperature, T _J		128-PDT high-K JEDEC board, R θ_{JA} = 74.6°C/W, P _D = 0.36 W		T _A = 70°C	96.8	°C
				T _A = 85°C	111.9	°C
		128-PDT low-K JEDEC board, R θ_{JA} = 101.3°C/W, P _D = 0.36 W		T _A = 70°C	106.4	°C
				T _A = 85°C	121.5	°C
Power up reset time, t _{pu}		$\overline{G_RST}$ input		2		ms
Receive input jitter		TPA, TPB cable inputs, S100 operation			±1.08	ns
		TPA, TPB cable inputs, S200 operation			±0.5	
		TPA, TPB cable inputs, S400 operation			±0.315	

[†] Applies to external inputs and bidirectional buffers without hysteresis.

[‡] Miscellaneous terminals are: GPIO2 (90), GPIO3 (89), SDA (92), SCL (91).

[§] Applies to external output buffers.

[¶] For a node that does not source power; see section 4.2.2.2 in IEEE Std 1394a-2000.

Recommended Operating Conditions (Continued)

		TEST CONDITION	MIN	NOM	MAX	UNIT
Receive input skew	Between TPA and TPB cable inputs, S100 operation				±0.8	ns
	Between TPA and TPB cable inputs, S200 operation				±0.55	
	Between TPA and TPB cable inputs, S400 operation				±0.5	

9.3 Electrical Characteristics Over Recommended Operating Conditions (unless otherwise noted)

PARAMETER		OPERATION	TEST CONDITIONS	MIN	MAX	UNIT
V _{OH} High-level output voltage	PCI		I _{OH} = -0.5 mA	0.9DV _{DD}		V
			I _{OH} = -2 mA	2.4		
	Miscellaneous‡		I _{OH} = -4 mA	DV _{DD} -0.6		
V _{OL} Low-level output voltage	PCI		I _{OL} = 1.5 mA	0.1DV _{DD}		V
			I _{OL} = 6 mA	0.55		
	Miscellaneous‡		I _{OL} = 4 mA	0.5		
I _{OZ} 3-state output high-impedance	Output pins	3.6 V	V _O = DV _{DD} or GND	±20		μA
I _{IL} Low-level input current	Input pins	3.6 V	V _I = GND	±20		μA
	I/O pins†	3.6 V	V _I = GND	±20		
I _{IH} High-level input current	PCI†	3.6 V	V _I = DV _{DD}	±20		μA
	Others†	3.6 V	V _I = DV _{DD}	±20		

† For I/O terminals, input leakage (I_{IL} and I_{IH}) includes I_{OZ} of the disabled output.

‡ Miscellaneous terminals are: GPIO2 (90), GPIO3 (89), SDA (92), SCL (91).

9.4 Electrical Characteristics Over Recommended Ranges of Operating Conditions (unless otherwise noted)

9.4.1 Device

PARAMETER		TEST CONDITIONS	MIN	TYP	MAX	UNIT
I _{DD}	Supply current (internal voltage regulator enabled, REG_EN = L)	See Note 4		33		mA
		See Note 5		8.1		
I _{DD}	Supply current (REG_EN = H, external 1.8 V supplied to REG18)	See Note 4		31.5		mA
		See Note 5		6.6		
I _{DD(ULP)}	Supply current—ultralow power mode (internal voltage regulator enabled, REG_EN = L)	Ports disabled V _{DD} = 1.8 V (internal) T _A = 25°C		1.5		mA
I _{DD(ULP)}	Supply current—ultralow power mode (internal voltage regulator disabled, REG_EN = H, REG18 = 1.8 V)	Ports disabled V _{DD} = 1.8 V (external) T _A = 25°C		35		μA
V _{TH}	Power status threshold, CPS input [†]	400-kΩ resistor [†]	4.7		7.5	V
V _O	TPBIAS output voltage	At rated I _O current	1.665		2.015	V
I _I	Input current (PC0–PC2 inputs)	V _{DD} = 3.6 V			5	μA
I _{IIRST}	Pullup current ($\overline{\text{G_RST}}$ input)	V _I = 1.5 V	-90		-20	μA
		V _I = 0 V	-90		-20	

[†] Measured at cable power side of resistor.

NOTES: 4. Transmit (all ports transmit, 100% bandwidth, S400), V_{DD} = 3.3 V, T_A = 25°C

5. Idle (receive or transmit cycle start on the port), V_{DD} = 3.3 V, T_A = 25°C

9.4.2 Driver

PARAMETER		TEST CONDITIONS	MIN	MAX	UNIT
V _{OD}	Differential output voltage	56 Ω, see Figure 9–1	172	265	mV
I _{DIFF}	Driver difference current, TPA+, TPA–, TPB+, TPB–	Drivers enabled, speed signaling off	-1.05 [‡]	1.05 [‡]	mA
I _{SP200}	Common-mode speed signaling current, TPB+, TPB–	S200 speed signaling enabled	-4.84 [§]	-2.53 [§]	mA
I _{SP400}	Common-mode speed signaling current, TPB+, TPB–	S400 speed signaling enabled	-12.4 [§]	-8.1 [§]	mA
V _{OFF}	Off state differential voltage	Drivers disabled, see Figure 9–1		20	mV

[‡] Limits defined as algebraic sum of TPA+ and TPA– driver currents. Limits also apply to TPB+ and TPB– algebraic sum of driver currents.

[§] Limits defined as absolute limit of each of TPB+ and TPB– driver currents.

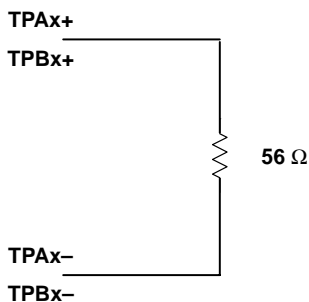

Figure 9–1. Test Load Diagram

9.4.3 Receiver

PARAMETER		TEST CONDITIONS	MIN	TYP	MAX	UNIT
Z _{ID}	Differential impedance	Drivers disabled	4	7		kΩ
					4	pF
Z _{IC}	Common-mode impedance	Drivers disabled	20			kΩ
					24	pF
V _{TH-R}	Receiver input threshold voltage	Drivers disabled	-30		30	mV
V _{TH-CB}	Cable bias detect threshold, TPBx cable inputs	Drivers disabled	0.6		1	V
V _{TH+}	Positive arbitration comparator threshold voltage	Drivers disabled	89		168	mV
V _{TH-}	Negative arbitration comparator threshold voltage	Drivers disabled	-168		-89	mV
V _{TH-SP200}	Speed signal threshold	TPBIAS-TPA common mode voltage, drivers disabled	49		131	mV
V _{TH-SP400}	Speed signal threshold	TPBIAS-TPA common mode voltage, drivers disabled	314		396	mV

9.5 Thermal Characteristics

PARAMETER		TEST CONDITIONS	MIN	TYP	MAX	UNIT
128-PDT	R _{θJA} , high-K board	Board mounted, no air flow, JEDEC test board			74.6	°C/W
128-PDT	R _{θJA} , low-K board				101.3	°C/W
128-PDT	R _{θJC}				18.7	°C/W

9.6 Switching Characteristics for PHY Port Interface

PARAMETER		TEST CONDITIONS	MIN	TYP	MAX	UNIT
	Jitter, transmit	Between TPA and TPB			±0.15	ns
	Skew, transmit	Between TPA and TPB			±0.1	ns
t _r	TP differential rise time, transmit	10% to 90%, at 1394 connector	0.5		1.2	ns
t _f	TP differential fall time, transmit	90% to 10%, at 1394 connector	0.5		1.2	ns

9.7 Operating, Timing, and Switching Characteristics of XI

PARAMETER		MIN	TYP	MAX	UNIT
V _{DD}		3.0	3.3	3.6	V (PLL _{VDD})
V _{IH}	High-level input voltage	0.63V _{DD}			V
V _{IL}	Low-level input voltage	0.33V _{DD}			V
	Input clock frequency	24.576			MHz
	Input clock frequency tolerance	<100			PPM
	Input slew rate	0.2		4	V/ns
	Input clock duty cycle	40%		60%	

9.8 Switching Characteristics for PCI Interface†

PARAMETER		MEASURED	MIN	TYP	MAX	UNIT
t _{su}	Setup time before PCLK	-50% to 50%	7			ns
t _h	Hold time before PCLK	-50% to 50%	0			ns
t _{val}	Delay time, PCLK to data valid	-50% to 50%	2		11	ns

† These parameters are ensured by design.

9.8.1 CardBus PC Card Clock Specifications

PARAMETER		MIN	MAX	UNIT
t_{cyc}	CCLK cycle time (see Note 6)	30	∞	ns
t_{high}	CCLK high time	12		ns
t_{low}	CCLK low time	12		ns
–	CCLK slew rate (see Note 7)	1	4	V/ns

- NOTES:
- In general, all CardBus PC Card components must work with any clock frequency up to 33 MHz. The clock frequency may be changed at any time during the operation of the system so long as the clock edges remain clean (monotonic) and the minimum cycle and high and low times are not violated. If the clock is stopped, it must be in a low state. A variance on this specification is allowed for the CardBus PC Card adapter which may operate the CardBus PC Card interface at any single fixed frequency up to 33 MHz, and may enforce a policy of no frequency changes.
 - Rise and fall times are specified in terms of the edge rate measured in V/ns. This slew rate must be met across the minimum peak-to-peak portion of the clock waveform (see Figure 9–2).

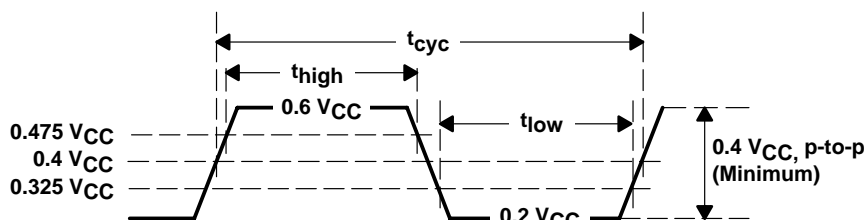

Figure 9–2. CardBus PC Card Clock Waveform

9.8.2 3.3-V Timing Parameters

		MIN	MAX	UNIT
t_{val}	CCLK-to-signal-valid delay (see Notes 8 and 9)	2	18	ns
t_{on}	Float-to-active delay (see Note 8)	2		ns
t_{off}	Active-to-float delay (see Note 8)		28	ns
t_{su}	Input set up time to CCLK (see Note 10)	7		ns
t_h	Input hold time from CCLK (see Note 10)	0		ns
t_{rst}	Reset active time after power stable (see Note 11)	1		ms
$t_{rst-clk}$	Reset active time after CCLK stable (see Note 11)	100		clocks
$t_{rst-off}$	Reset-active-to-output-float delay (see Notes 11 and 12)		40	ns
t_{pulse}	CSTSCHG remote wakeup pulse width (see Note 13)	1		ms

- NOTES:
- t_{val} includes the time to propagate data from internal registers to the output buffer and drive the output to a valid level. Minimum t_{val} is measured from CCLK crossing V_{test} to the signal crossing V_{IH} on falling edges and V_{IL} on rising edges. Maximum t_{val} is measured from CCLK crossing V_{test} to the signal's last transition out of the threshold region (V_{IL} for falling edges, V_{IH} for rising edges).
 - Minimum times are specified with 0-pF equivalent load; maximum times are specified with 30-pF equivalent load. Actual test capacitance may vary, but results must be correlated to these specifications. Systems which exceed this capacitance, due to long traces between the socket and adaptor, must reduce the CCLK frequency appropriately.
 - t_{su} and t_h are measured at V_{TH} for rising edges and V_{TL} for falling edges.
 - CRST is asserted asynchronously and negated synchronously with respect to CCLK. CCLK Stable means that V_{CC} is within tolerances and CCLK is meeting specifications.
 - See *PC Card Standard—Electrical Specification* for the CardBus PC Card and adapter signals which must be in a high-impedance state.
 - This parameter only applies when signaling remote wakeup over the CSTSCHG terminal. All other status change information must be signaled by asserting CSTSCHG until the resultant interrupt is serviced.

PACKAGING INFORMATION

Orderable Device	Status (1)	Package Type	Package Drawing	Pins	Package Qty	Eco Plan (2)	Lead finish/ Ball material (6)	MSL Peak Temp (3)	Op Temp (°C)	Device Marking (4/5)	Samples
TSB43AB21APDT	LIFEBUY	TQFP	PDT	128	90	RoHS & Green	NIPDAU	Level-3-260C-168 HR	0 to 70	TSB43AB21A	

(1) The marketing status values are defined as follows:

ACTIVE: Product device recommended for new designs.

LIFEBUY: TI has announced that the device will be discontinued, and a lifetime-buy period is in effect.

NRND: Not recommended for new designs. Device is in production to support existing customers, but TI does not recommend using this part in a new design.

PREVIEW: Device has been announced but is not in production. Samples may or may not be available.

OBSOLETE: TI has discontinued the production of the device.

(2) **RoHS:** TI defines "RoHS" to mean semiconductor products that are compliant with the current EU RoHS requirements for all 10 RoHS substances, including the requirement that RoHS substance do not exceed 0.1% by weight in homogeneous materials. Where designed to be soldered at high temperatures, "RoHS" products are suitable for use in specified lead-free processes. TI may reference these types of products as "Pb-Free".

RoHS Exempt: TI defines "RoHS Exempt" to mean products that contain lead but are compliant with EU RoHS pursuant to a specific EU RoHS exemption.

Green: TI defines "Green" to mean the content of Chlorine (Cl) and Bromine (Br) based flame retardants meet JS709B low halogen requirements of <=1000ppm threshold. Antimony trioxide based flame retardants must also meet the <=1000ppm threshold requirement.

(3) MSL, Peak Temp. - The Moisture Sensitivity Level rating according to the JEDEC industry standard classifications, and peak solder temperature.

(4) There may be additional marking, which relates to the logo, the lot trace code information, or the environmental category on the device.

(5) Multiple Device Markings will be inside parentheses. Only one Device Marking contained in parentheses and separated by a "-" will appear on a device. If a line is indented then it is a continuation of the previous line and the two combined represent the entire Device Marking for that device.

(6) Lead finish/Ball material - Orderable Devices may have multiple material finish options. Finish options are separated by a vertical ruled line. Lead finish/Ball material values may wrap to two lines if the finish value exceeds the maximum column width.

Important Information and Disclaimer:The information provided on this page represents TI's knowledge and belief as of the date that it is provided. TI bases its knowledge and belief on information provided by third parties, and makes no representation or warranty as to the accuracy of such information. Efforts are underway to better integrate information from third parties. TI has taken and continues to take reasonable steps to provide representative and accurate information but may not have conducted destructive testing or chemical analysis on incoming materials and chemicals. TI and TI suppliers consider certain information to be proprietary, and thus CAS numbers and other limited information may not be available for release.

In no event shall TI's liability arising out of such information exceed the total purchase price of the TI part(s) at issue in this document sold by TI to Customer on an annual basis.

OTHER QUALIFIED VERSIONS OF TSB43AB21A :

- Enhanced Product : [TSB43AB21A-EP](#)

NOTE: Qualified Version Definitions:

- Enhanced Product - Supports Defense, Aerospace and Medical Applications

TRAY

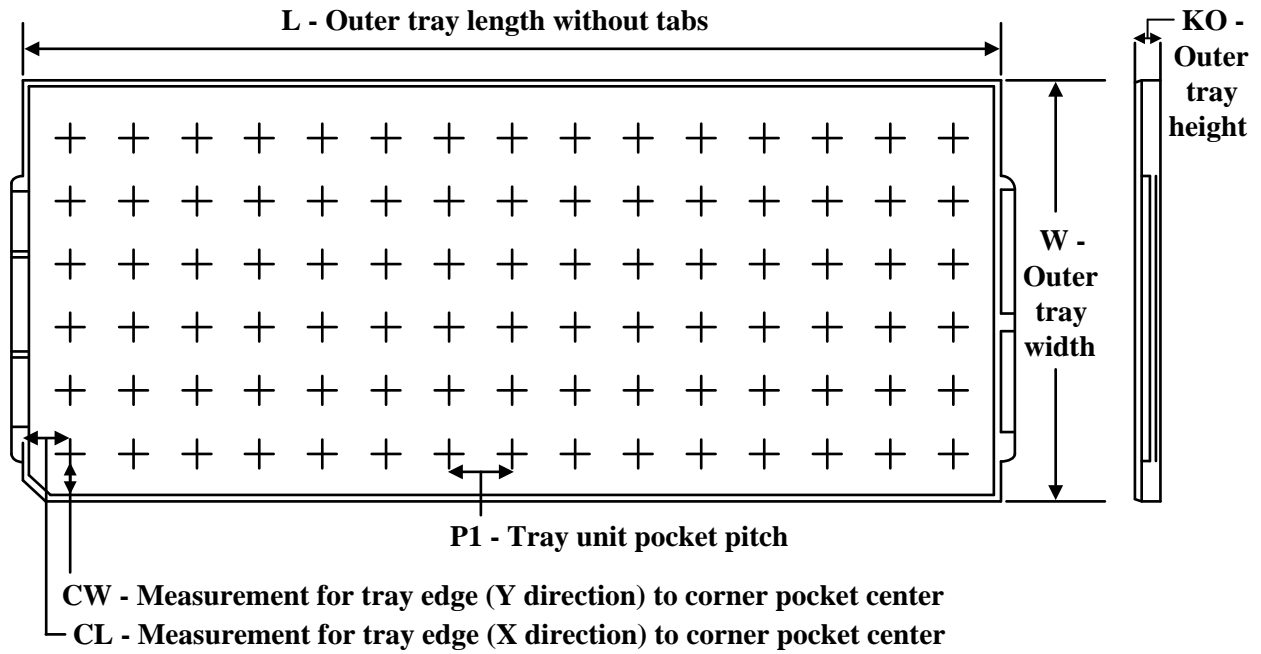

Chamfer on Tray corner indicates Pin 1 orientation of packed units.

*All dimensions are nominal

Device	Package Name	Package Type	Pins	SPQ	Unit array matrix	Max temperature (°C)	L (mm)	W (mm)	K0 (µm)	P1 (mm)	CL (mm)	CW (mm)
TSB43AB21APDT	PDT	TQFP	128	90	6 X 15	150	315	135.9	7620	15.4	20.3	21

IMPORTANT NOTICE AND DISCLAIMER

TI PROVIDES TECHNICAL AND RELIABILITY DATA (INCLUDING DATA SHEETS), DESIGN RESOURCES (INCLUDING REFERENCE DESIGNS), APPLICATION OR OTHER DESIGN ADVICE, WEB TOOLS, SAFETY INFORMATION, AND OTHER RESOURCES "AS IS" AND WITH ALL FAULTS, AND DISCLAIMS ALL WARRANTIES, EXPRESS AND IMPLIED, INCLUDING WITHOUT LIMITATION ANY IMPLIED WARRANTIES OF MERCHANTABILITY, FITNESS FOR A PARTICULAR PURPOSE OR NON-INFRINGEMENT OF THIRD PARTY INTELLECTUAL PROPERTY RIGHTS.

These resources are intended for skilled developers designing with TI products. You are solely responsible for (1) selecting the appropriate TI products for your application, (2) designing, validating and testing your application, and (3) ensuring your application meets applicable standards, and any other safety, security, regulatory or other requirements.

These resources are subject to change without notice. TI grants you permission to use these resources only for development of an application that uses the TI products described in the resource. Other reproduction and display of these resources is prohibited. No license is granted to any other TI intellectual property right or to any third party intellectual property right. TI disclaims responsibility for, and you will fully indemnify TI and its representatives against, any claims, damages, costs, losses, and liabilities arising out of your use of these resources.

TI's products are provided subject to [TI's Terms of Sale](#) or other applicable terms available either on [ti.com](https://www.ti.com) or provided in conjunction with such TI products. TI's provision of these resources does not expand or otherwise alter TI's applicable warranties or warranty disclaimers for TI products.

TI objects to and rejects any additional or different terms you may have proposed.

Mailing Address: Texas Instruments, Post Office Box 655303, Dallas, Texas 75265
Copyright © 2024, Texas Instruments Incorporated