

TPS75003EVM User's Guide

Contents

1	Introduction	1
2	Performance Specification Summary	1
3	Modifications	2
4	Board Layout	5
5	Schematic	11
6	Bill of Materials	12

List of Figures

1	Efficiency With $V_{IN} = 5\text{ V}$, $V_{OUT1} = 1.2\text{ V}$, $V_{OUT2} = 3.3\text{ V}$	3
2	Normalized Load Regulation With $V_{IN} = 5\text{ V}$, $V_{OUT1} = 1.2\text{ V}$, $V_{OUT2} = 3.3\text{ V}$	4
3	Output Ripple when $V_{IN} = 5\text{ V}$, $V_{OUT1} = 1.2\text{ V}$, $I_{OUT1} = 2\text{ A}$	4
4	Output Ripple When $V_{IN} = 5\text{ V}$, $V_{OUT2} = 3.3\text{ V}$, $I_{OUT2} = 2\text{ A}$	5
5	Soft Start With $V_{IN} = 5.0\text{ V}$	5
6	Top Layer	6
7	Bottom Layer	7
8	Top Assembly	8
9	Layer 2	9
10	Layer 3	10
11	TPS75003EVM Schematic	11

List of Tables

1	Typical Performance Specification Summary	2
2	TPS75003EVM Bill of Materials	12

1 Introduction

The Texas Instruments TPS75003EVM evaluation module (EVM) helps designers evaluate the operation and performance of the TPS75003 multi-channel power IC. This device has two buck controllers and a low dropout linear regulator. The device will operate at input voltages between 2.2 V and 6.5 V. The buck controllers can provide output voltages between 1.22 V and the input voltage and output currents up to 3 A. This EVM is specifically designed and optimized to operate from a 5 V input with output currents up to 2 A for $V_{OUT1} = 1.2\text{ V}$ typical and $V_{OUT2} = 3.3\text{ V}$ typical. In addition, the EVM is jumper configurable so that each output can be independently enabled or the outputs can be sequenced in the following order: V_{OUT3} , V_{OUT2} then V_{OUT1} .

2 Performance Specification Summary

Table 1 provides a summary of the TPS75003EVM performance specifications. All specifications are given for an ambient temperature of 25°C.

Table 1. Typical Performance Specification Summary

	CONDITION	VOLTAGE RANGE (V)			CURRENT RANGE (mA)		
		MIN	TYP	MAX	MIN	TYP	MAX
V _{OUT1} Buck Controller	V _I = 5 V	1.18	1.22	1.26	0		2000
V _{OUT2} Buck Controller	V _I = 5 V	3.15	3.30	3.43	0		2000
V _{OUT3} Linear Regulator	V _I = 5 V	2.41	2.50	2.65	0		300

3 Modifications

Passive components with 603 or larger footprints were used to allow for user customization. Additionally, a second soft start capacitor was added for buck controller but not populated to allow the soft start timing to be easily modified.

Input capacitor C1 was included to minimize inductive droop due to long leads from a bench power supply. A capacitor of similar size may or may not be needed in a real application depending on the proximity to the input power supply.

If all of the output voltages are equal to or greater than the minimum 1.4V threshold for EN1 and EN2, then the outputs can be sequenced in any order by simply modifying the V_{OUTx} to ENx connections. If one of the buck output voltages is between 1.2V and 1.4V, then only EN3 with its minimum 1.1V threshold can be enabled by this output voltage. For example, if V_{OUT1}=1.2V, V_{OUT2}=3.3V and V_{OUT3}=2.5V, the following additional sequencing options are available by modifying the EVM's V_{OUTx} to ENx connections: V_{OUT1}=1.2V, V_{OUT3}=2.5V then V_{OUT2}=3.3V or V_{OUT2}=3.3V, V_{OUT3}=2.5V then V_{OUT1}=1.2V. An external SVS, like the TPS3808, monitoring the 1.2V to 1.4V rail and with its RESET output tied to ENx can be used to provide the remaining sequencing options.

3.1 Input/Output Connector Descriptions

This chapter describes the jumpers and connectors on the EVM as well as how to properly connect, setup, and use the TPS75003EVM.

J1 – VIN — This is the positive connection to the input power supply. The leads to the input supply should be twisted and kept as short as possible to minimize EMI transmission.

J2 – GND — This is the return connection for the input power supply.

J3 – VOUT1 — This is the positive connection for the V_{OUT1} output. Connect this pin to the positive input of the V_{OUT1} load.

J4 – GND — This is the negative connection for the V_{OUT1} output. Connect this pin to the negative input of the V_{OUT1} load.

J5 – VOUT2 — This is the positive connection for the V_{OUT2} output. Connect this pin to the positive input of the V_{OUT2} load.

J6 – GND — This is the negative connection for the V_{OUT2} output. Connect this pin to the negative input of the V_{OUT2} load.

J7 – VOUT3 — This is the positive connection for the V_{OUT3} output. Connect this pin to the positive input of the V_{OUT3} load.

J8 – GND — This is the negative connection for the V_{OUT3} output. Connect this pin to the negative input of the V_{OUT3} load.

JP1 – EN VO1 — This jumper enables and disables V_{OUT1}. With the jumper removed (DEFAULT), EN1 is pulled low by an external pulldown resistor and V_{OUT1} is disabled. With the jumper tied to V_{IN}, EN1 is pulled high to V_{IN} and V_{OUT1} is enabled. With the jumper tied to AFTER VO2, EN1 is tied to V_{OUT2} so that V_{OUT1} will not be enabled until after V_{OUT2} is enabled.

JP2 – EN VO2 — This jumper enables and disables V_{OUT2} . With the jumper removed (DEFAULT), EN2 is pulled low by an external pulldown resistor and V_{OUT2} is disabled. With the jumper installed, EN2 is pulled high to V_{IN} and V_{OUT2} is enabled. With the jumper tied to AFTER VO3, EN3 is tied to V_{OUT3} so that V_{OUT2} will not be enabled until after V_{OUT3} is enabled.

JP3 – EN VO3 — This jumper enables and disables V_{OUT3} . With the jumper removed (DEFAULT), EN3 is pulled low by an external pulldown resistor and V_{OUT3} is disabled. With the jumper tied to V_{IN} , EN3 is pulled high to V_{IN} and V_{OUT3} is enabled.

3.2 Setup

Connect an input supply between J1 and J2. The voltage range on this supply should stay between 2.2 V and 6.5 V. Connect a load not to exceed 2 A for the buck controllers between J3 and J4 for V_{OUT1} and between J5 and J6 for V_{OUT2} . Connect a load not to exceed 300 mA for the linear regulator between J7 and J8. Configure the JP1, JP2 and JP3 enabling jumpers to the desired setting. To prevent noise pickup from distorting voltage measurements of any of the three output voltages, keep the loop created by the voltage probe tip and its ground connection as small as possible and as far away as possible from the inductors on the board.

3.3 Test Results

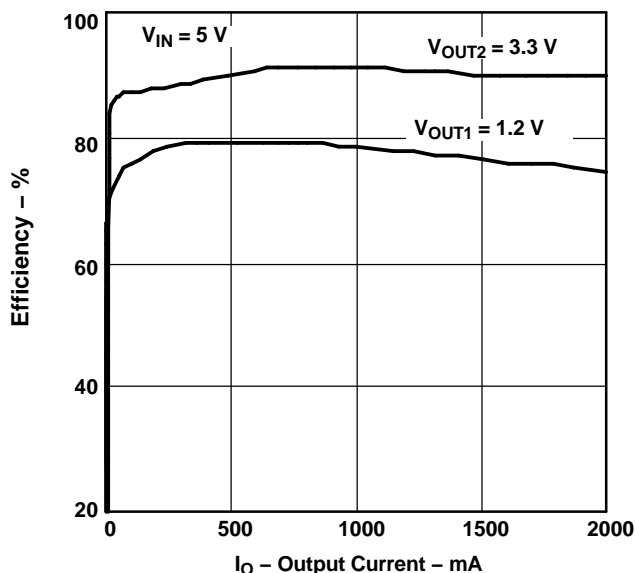

A Efficiency may be improved or degraded by using different FETs and/or inductors.

Figure 1. Efficiency With $V_{IN} = 5\text{ V}$, $V_{OUT1} = 1.2\text{ V}$, $V_{OUT2} = 3.3\text{ V}$

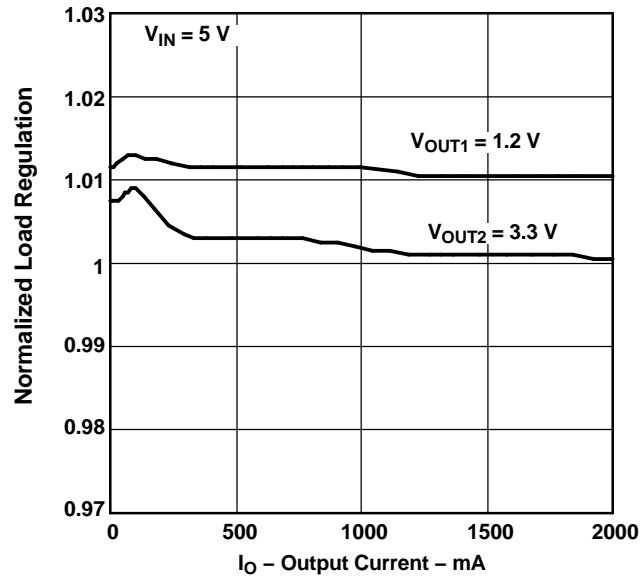

Figure 2. Normalized Load Regulation With $V_{IN} = 5\text{ V}$, $V_{OUT1} = 1.2\text{ V}$, $V_{OUT2} = 3.3\text{ V}$

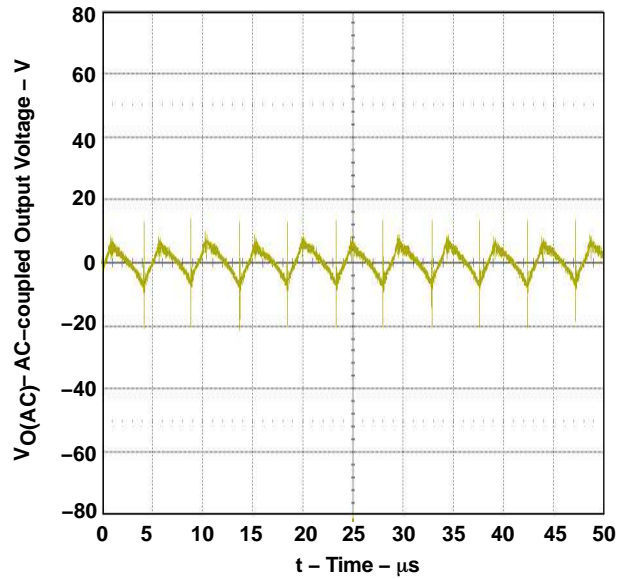

Figure 3. Output Ripple when $V_{IN} = 5\text{ V}$, $V_{OUT1} = 1.2\text{ V}$, $I_{OUT1} = 2\text{ A}$

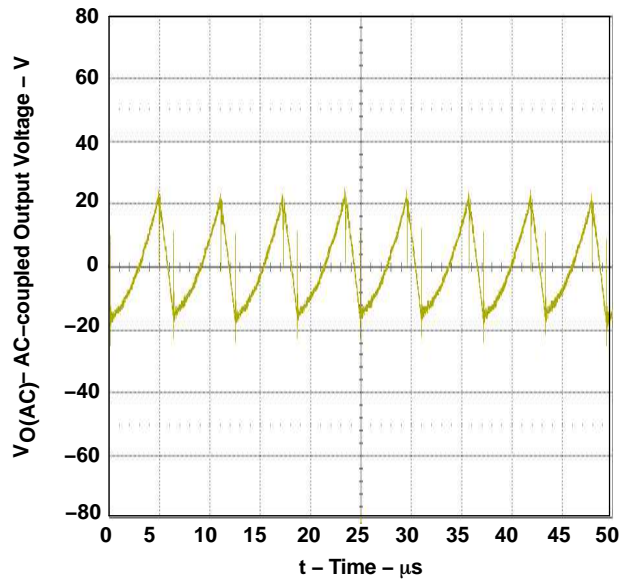

Figure 4. Output Ripple When $V_{IN} = 5\text{ V}$, $V_{OUT2} = 3.3\text{ V}$, $I_{OUT2} = 2\text{ A}$

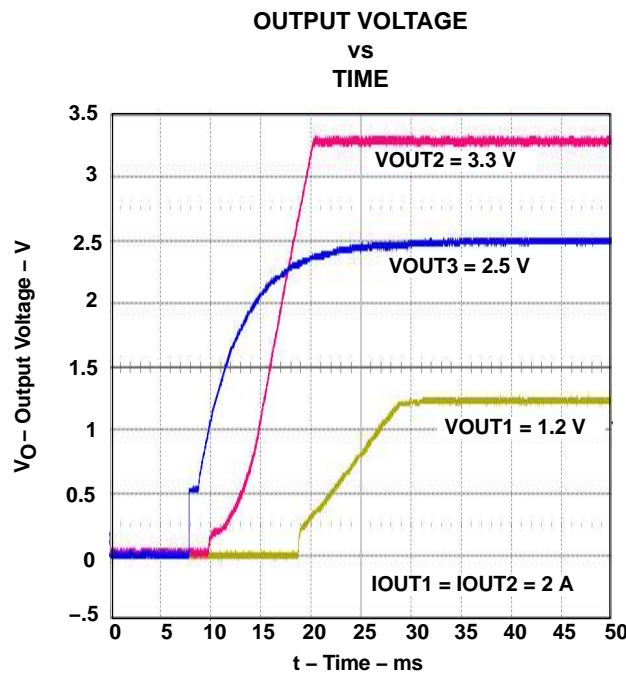

Figure 5. Soft Start With $V_{IN} = 5.0\text{ V}$

4 Board Layout

Board layout is critical for all switch mode power supplies. The following figures show each of the four layers of the TPS75003EVM PWB. The nodes with high switching frequencies and currents are short and are isolated from the noise sensitive feedback circuitry. Careful attention has been given to the routing of high frequency current loops. The sense resistors for the current limit and soft start should be placed between the INx and ISx pins as close to the IC as possible. Refer to the TPS75003 data sheet (literature number SBVS052) for additional layout guidelines.

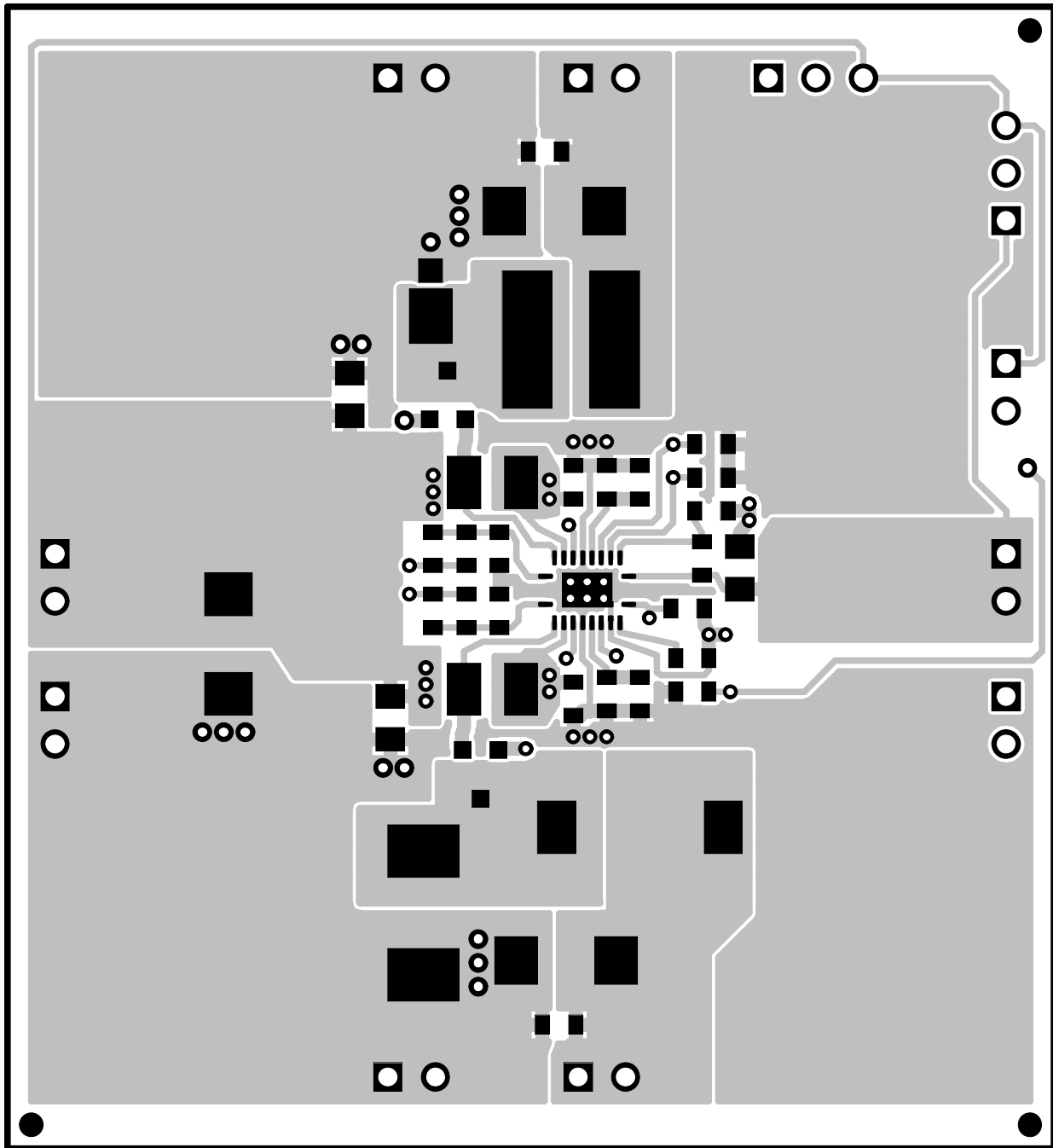

Figure 6. Top Layer

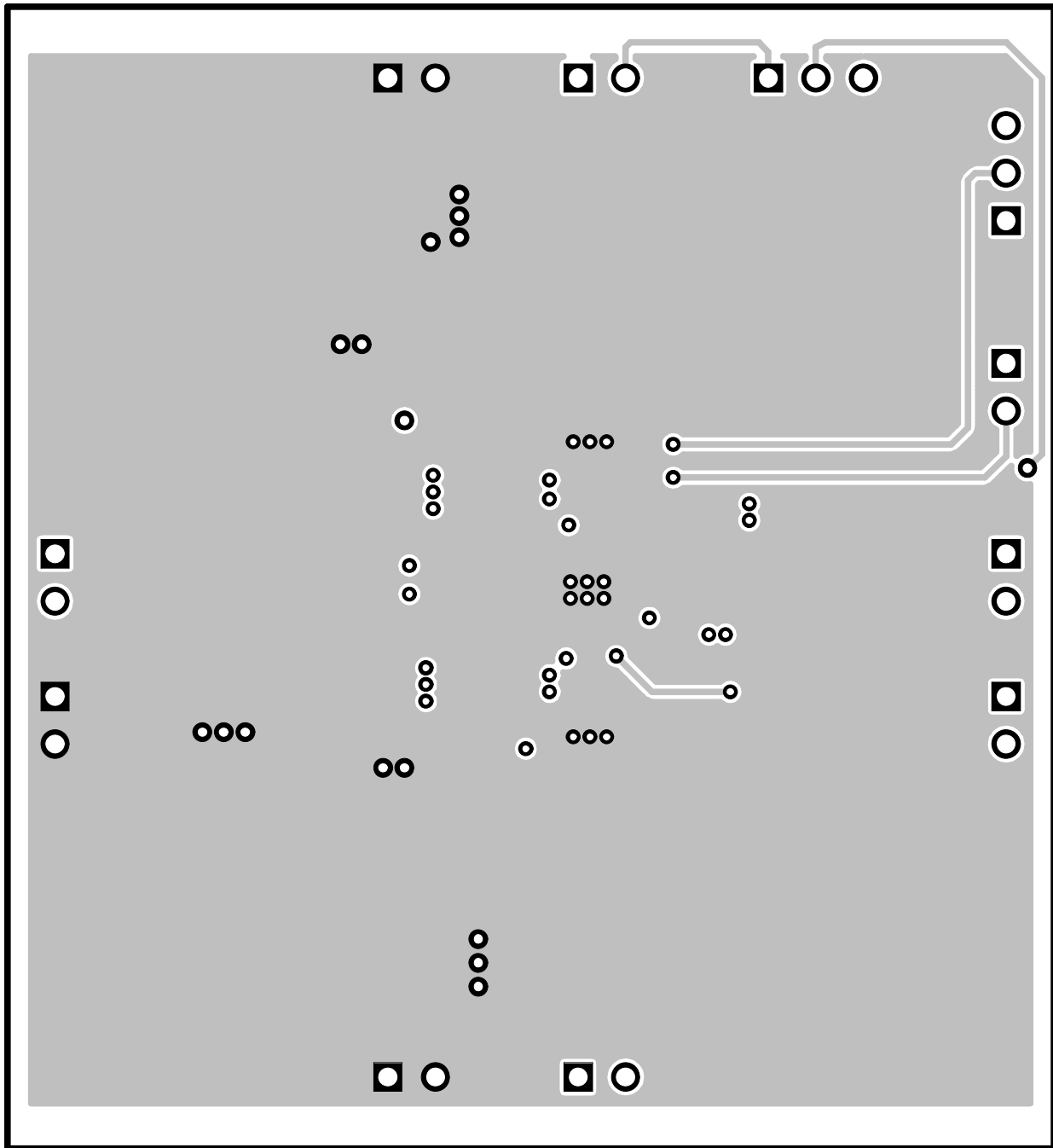

Figure 7. Bottom Layer

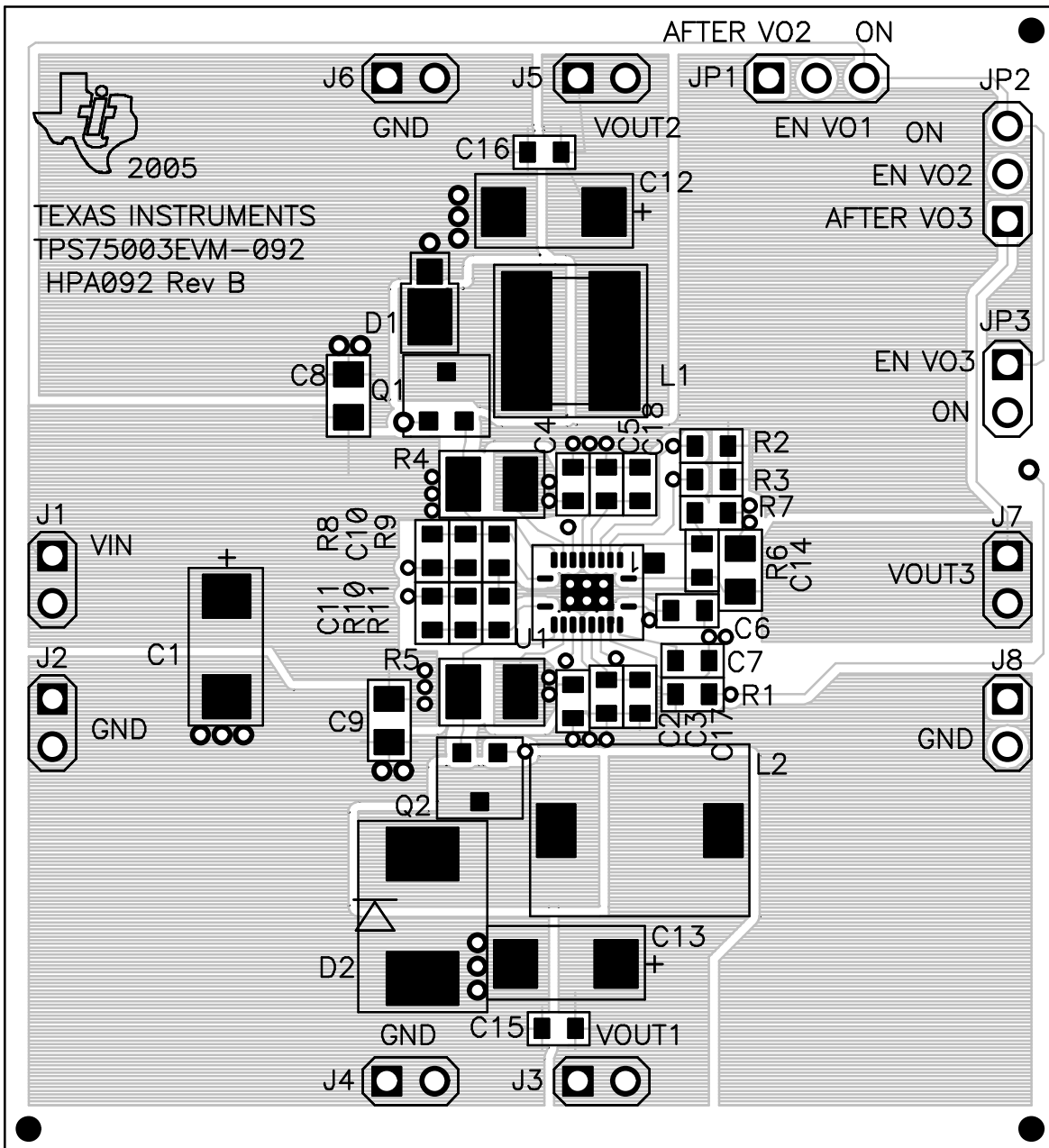

Figure 8. Top Assembly

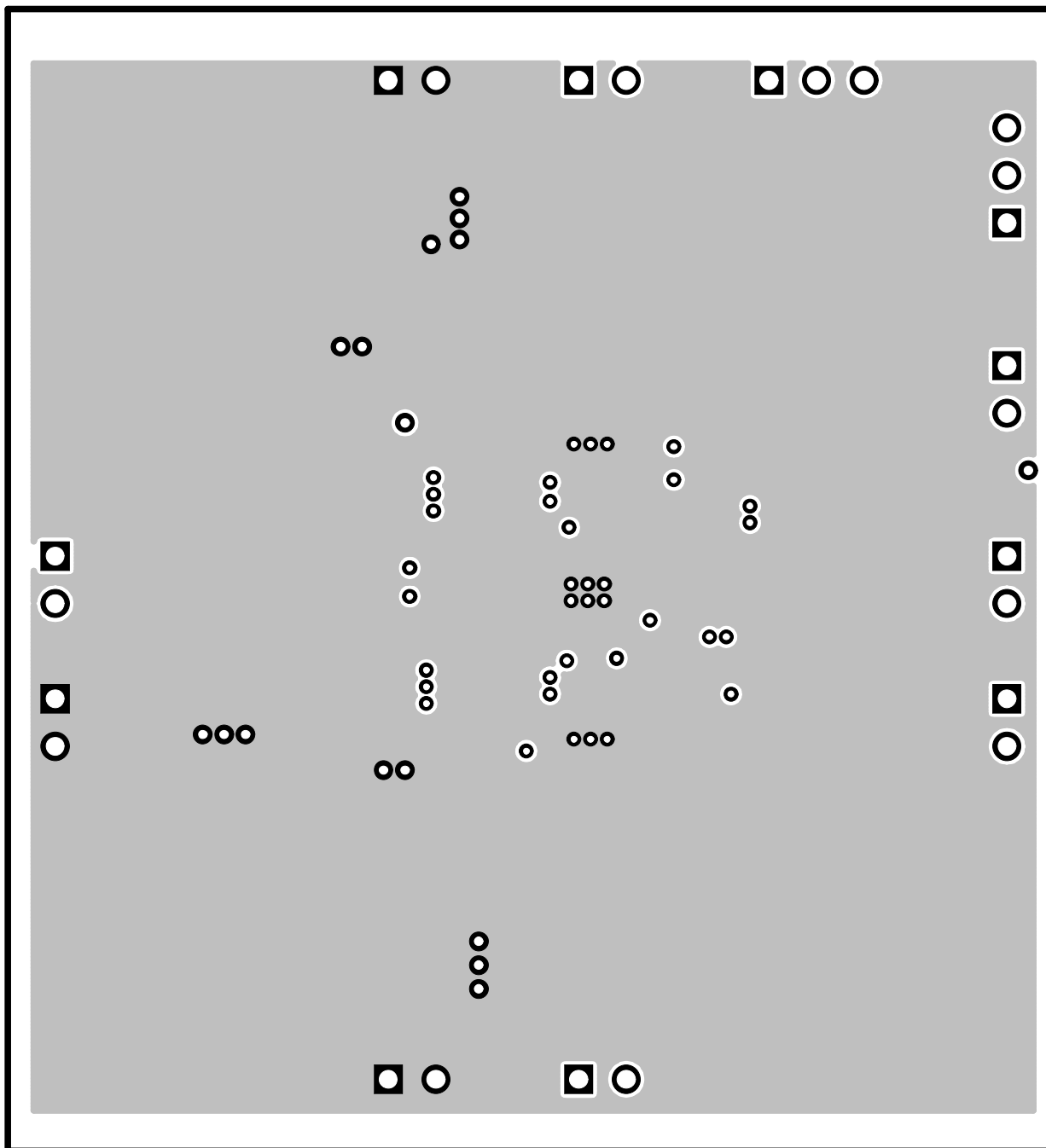

Figure 9. Layer 2

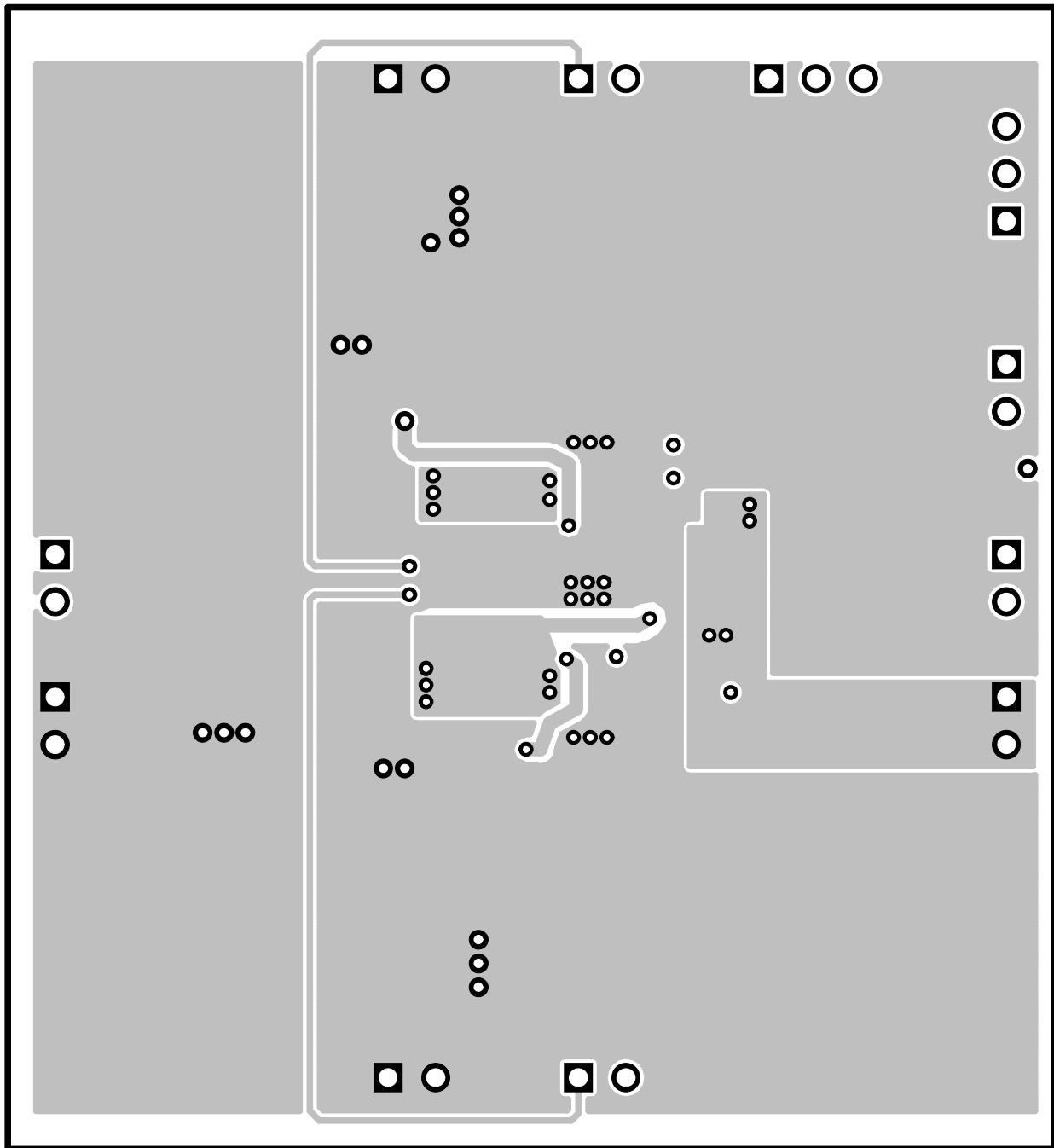

Figure 10. Layer 3

5 Schematic

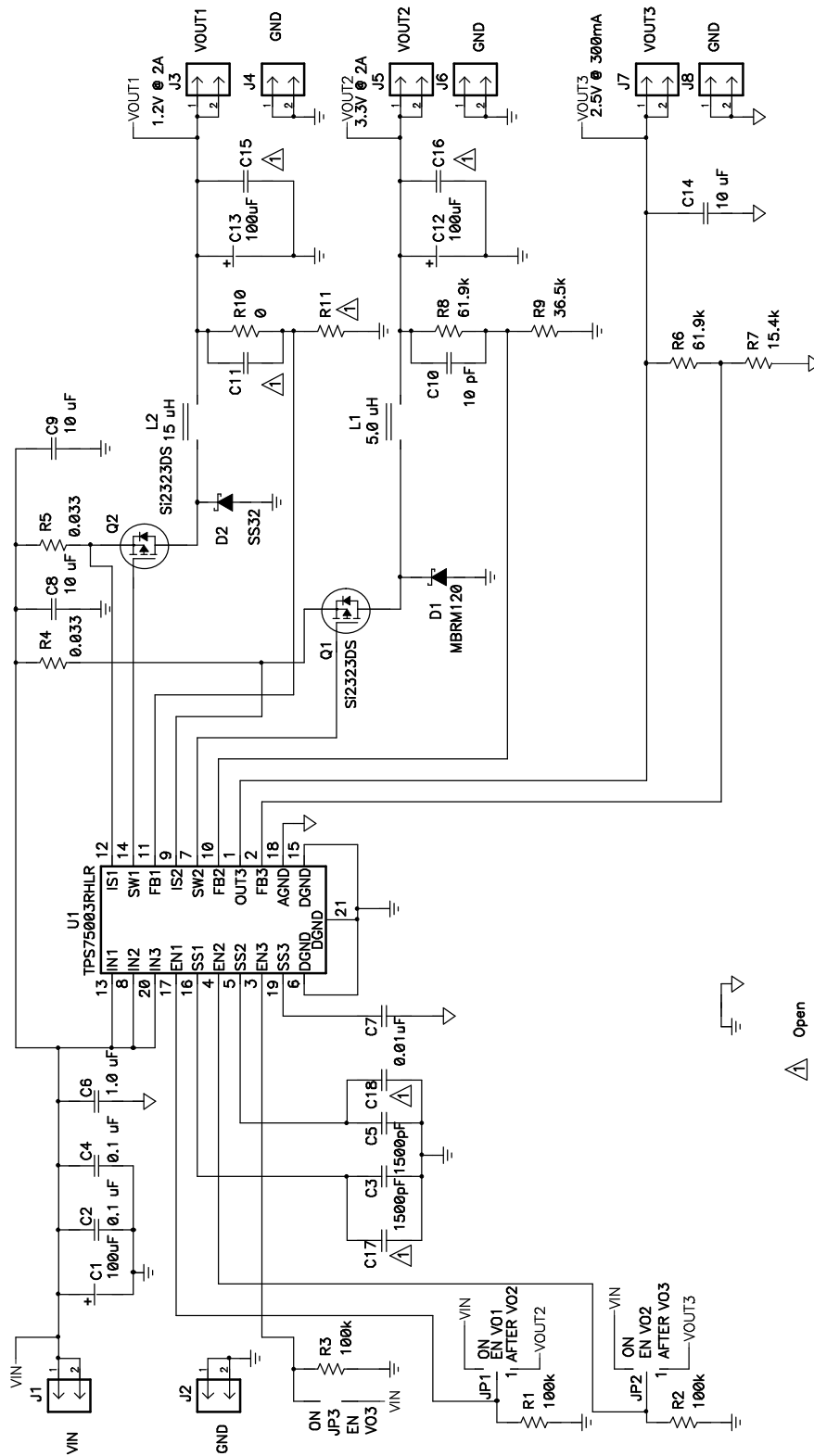

Figure 11. TPS75003EVM Schematic

6 Bill of Materials
Table 2. TPS75003EVM Bill of Materials

COUNT	Ref Des	DESCRIPTION	SIZE	MFR	PART NUMBER
3	C1, C12, C13	Capacitor, POSCAP, 100- μ F, 6.3-V, 45-m Ω , 20%	6032 (C)	Sanyo	6TPB100MC
1	C10	Capacitor, Ceramic, 10-pF, 50-V, C0G, 5%	603	TDK	C1608C0G1H100D
0	C11, C15–C18	Capacitor, Ceramic, xx- μ F, xx-V	603		
2	C2, C4	Capacitor, Ceramic, 0.1- μ F, 16-V, X7R, 10%	603	TDK	C1608X7R1C104K
2	C3, C5	Capacitor, Ceramic, 1500-pF, 50-V, X7R, 10%	603	TDK	C1608X7R1H152K
1	C6	Capacitor, Ceramic, 1.0- μ F, 6.3-V, X5R, 10%	603	TDK	C1608X5R0J105K
1	C7	Capacitor, Ceramic, 0.01- μ F, 50-V, X7R, 10%	603	TDK	C1608X7R1H103K
3	C8, C9, C14	Capacitor, Ceramic, 10- μ F, 10-V, X5R, 20%	805	TDK	C2012X5R1A106MT
1	D1	Diode, Schottky, 1A, 20 V	457-04	On Semi	MBRM120
1	D2	Diode, Schottky, 3.0-A, 20 V	SMC	Vishay	SS32
8	J1–J8	Header, 2-pin, 100 mil spacing, (36-pin strip)	0.100 x 2	Sullins	PTC36SAAN
1	JP2	Header, 2-pin, 100 mil spacing, (36-pin strip)	0.100 x 2	Sullins	PTC36SAAN
2	JP1, JP3	Header, 3-pin, 100 mil spacing, (36-pin strip)	0.100 x 3	Sullins	PTC36SAAN
1	L1	Inductor, SMT, 5.0- μ H, 2.9-mA, 24-m Ω	0.264 sq	Sumida	CDRH6D38-5R0
1	L2	Inductor, SMT, 15- μ H, 2.6-A, 53-m Ω	0.327 x 0.327	Sumida	CDRH8D43-150
2	Q1, Q2	MOSFET, P-ch, 20-V, 4.7-A, 39-m Ω	SOT23	Vishay	Si2323DS
3	R1–R3	Resistor, chip, 100 k Ω , 1/16 W, 1%	603	Std	Std
1	R10	Resistor, chip, 0- Ω , 1/16 W, 5%	603	Std	Std
0	R11	Resistor, chip, xx- Ω , 1/16 W, 1%	603		
2	R4, R5	Resistor, chip, 0.033- Ω , 1/4 W, 1%	1210	Std	Std
2	R6, R8	Resistor, chip, 61.9 k Ω , 1/16 W, 1%	603	Std	Std
1	R7	Resistor, chip, 15.4 k Ω , 1/16 W, 1%	603	Std	Std
1	R9	Resistor, chip, 36.5 k Ω , 1/16 W, 1%	603	Std	Std
1	U1	IC, Triple Channel DC/DC Converter	QFN-20	TI	TPS75003RHRLR
1	—	PCB, 2.4 In x 2.2 In x 0.062 In		Any	HPA092
3	—	Shunt, 100-mil, black	0.100	3M	929950-00

FCC Warning

This evaluation board/kit is intended for use for **ENGINEERING DEVELOPMENT, DEMONSTRATION, OR EVALUATION PURPOSES ONLY** and is not considered by TI to be a finished end-product fit for general customer use. It generates, uses, and can radiate radio frequency energy and has not been tested for compliance with the limits of computing devices pursuant to part 15 of FCC rules, which are designed to provide reasonable protection against radio frequency interference. Operation of this equipment in other environments may cause interference with radio communications, in which case the user at his own expense will be required to take whatever measures may be required to correct this interference. - SSZZ017A - February 2006

EVALUATION BOARD/KIT IMPORTANT NOTICE

Texas Instruments (TI) provides the enclosed product(s) under the following conditions:

This evaluation board/kit is intended for use for **ENGINEERING DEVELOPMENT, DEMONSTRATION, OR EVALUATION PURPOSES ONLY** and is not considered by TI to be a finished end-product fit for general consumer use. Persons handling the product(s) must have electronics training and observe good engineering practice standards. As such, the goods being provided are not intended to be complete in terms of required design-, marketing-, and/or manufacturing-related protective considerations, including product safety and environmental measures typically found in end products that incorporate such semiconductor components or circuit boards. This evaluation board/kit does not fall within the scope of the European Union directives regarding electromagnetic compatibility, restricted substances (RoHS), recycling (WEEE), FCC, CE or UL, and therefore may not meet the technical requirements of these directives or other related directives.

Should this evaluation board/kit not meet the specifications indicated in the User's Guide, the board/kit may be returned within 30 days from the date of delivery for a full refund. **THE FOREGOING WARRANTY IS THE EXCLUSIVE WARRANTY MADE BY SELLER TO BUYER AND IS IN LIEU OF ALL OTHER WARRANTIES, EXPRESSED, IMPLIED, OR STATUTORY, INCLUDING ANY WARRANTY OF MERCHANTABILITY OR FITNESS FOR ANY PARTICULAR PURPOSE.**

The user assumes all responsibility and liability for proper and safe handling of the goods. Further, the user indemnifies TI from all claims arising from the handling or use of the goods. Due to the open construction of the product, it is the user's responsibility to take any and all appropriate precautions with regard to electrostatic discharge.

EXCEPT TO THE EXTENT OF THE INDEMNITY SET FORTH ABOVE, NEITHER PARTY SHALL BE LIABLE TO THE OTHER FOR ANY INDIRECT, SPECIAL, INCIDENTAL, OR CONSEQUENTIAL DAMAGES.

TI currently deals with a variety of customers for products, and therefore our arrangement with the user **is not exclusive.**

TI assumes **no liability for applications assistance, customer product design, software performance, or infringement of patents or services described herein.**

Please read the User's Guide and, specifically, the Warnings and Restrictions notice in the User's Guide prior to handling the product. This notice contains important safety information about temperatures and voltages. For additional information on TI's environmental and/or safety programs, please contact the TI application engineer or visit www.ti.com/esh.

No license is granted under any patent right or other intellectual property right of TI covering or relating to any machine, process, or combination in which such TI products or services might be or are used.

EVM WARNINGS AND RESTRICTIONS

It is important to operate this EVM within the input voltage range of 2.2 V to 6.5 V and the output voltage range of 1.0 V to 5.5 V.

Exceeding the specified input range may cause unexpected operation and/or irreversible damage to the EVM. If there are questions concerning the input range, please contact a TI field representative prior to connecting the input power.

Applying loads outside of the specified output range may result in unintended operation and/or possible permanent damage to the EVM. Please consult the EVM User's Guide prior to connecting any load to the EVM output. If there is uncertainty as to the load specification, please contact a TI field representative.

During normal operation, some circuit components may have case temperatures greater than 125° C. The EVM is designed to operate properly with certain components above 85° C as long as the input and output ranges are maintained. These components include but are not limited to linear regulators, switching transistors, pass transistors, and current sense resistors. These types of devices can be identified using the EVM schematic located in the EVM User's Guide. When placing measurement probes near these devices during operation, please be aware that these devices may be very warm to the touch.

Mailing Address: Texas Instruments, Post Office Box 655303, Dallas, Texas 75265
Copyright © 2006, Texas Instruments Incorporated

IMPORTANT NOTICE

Texas Instruments Incorporated and its subsidiaries (TI) reserve the right to make corrections, modifications, enhancements, improvements, and other changes to its products and services at any time and to discontinue any product or service without notice. Customers should obtain the latest relevant information before placing orders and should verify that such information is current and complete. All products are sold subject to TI's terms and conditions of sale supplied at the time of order acknowledgment.

TI warrants performance of its hardware products to the specifications applicable at the time of sale in accordance with TI's standard warranty. Testing and other quality control techniques are used to the extent TI deems necessary to support this warranty. Except where mandated by government requirements, testing of all parameters of each product is not necessarily performed.

TI assumes no liability for applications assistance or customer product design. Customers are responsible for their products and applications using TI components. To minimize the risks associated with customer products and applications, customers should provide adequate design and operating safeguards.

TI does not warrant or represent that any license, either express or implied, is granted under any TI patent right, copyright, mask work right, or other TI intellectual property right relating to any combination, machine, or process in which TI products or services are used. Information published by TI regarding third-party products or services does not constitute a license from TI to use such products or services or a warranty or endorsement thereof. Use of such information may require a license from a third party under the patents or other intellectual property of the third party, or a license from TI under the patents or other intellectual property of TI.

Reproduction of information in TI data books or data sheets is permissible only if reproduction is without alteration and is accompanied by all associated warranties, conditions, limitations, and notices. Reproduction of this information with alteration is an unfair and deceptive business practice. TI is not responsible or liable for such altered documentation.

Resale of TI products or services with statements different from or beyond the parameters stated by TI for that product or service voids all express and any implied warranties for the associated TI product or service and is an unfair and deceptive business practice. TI is not responsible or liable for any such statements.

TI products are not authorized for use in safety-critical applications (such as life support) where a failure of the TI product would reasonably be expected to cause severe personal injury or death, unless officers of the parties have executed an agreement specifically governing such use. Buyers represent that they have all necessary expertise in the safety and regulatory ramifications of their applications, and acknowledge and agree that they are solely responsible for all legal, regulatory and safety-related requirements concerning their products and any use of TI products in such safety-critical applications, notwithstanding any applications-related information or support that may be provided by TI. Further, Buyers must fully indemnify TI and its representatives against any damages arising out of the use of TI products in such safety-critical applications.

TI products are neither designed nor intended for use in military/aerospace applications or environments unless the TI products are specifically designated by TI as military-grade or "enhanced plastic." Only products designated by TI as military-grade meet military specifications. Buyers acknowledge and agree that any such use of TI products which TI has not designated as military-grade is solely at the Buyer's risk, and that they are solely responsible for compliance with all legal and regulatory requirements in connection with such use.

TI products are neither designed nor intended for use in automotive applications or environments unless the specific TI products are designated by TI as compliant with ISO/TS 16949 requirements. Buyers acknowledge and agree that, if they use any non-designated products in automotive applications, TI will not be responsible for any failure to meet such requirements.

Following are URLs where you can obtain information on other Texas Instruments products and application solutions:

Products		Applications	
Amplifiers	amplifier.ti.com	Audio	www.ti.com/audio
Data Converters	dataconverter.ti.com	Automotive	www.ti.com/automotive
DSP	dsp.ti.com	Broadband	www.ti.com/broadband
Interface	interface.ti.com	Digital Control	www.ti.com/digitalcontrol
Logic	logic.ti.com	Military	www.ti.com/military
Power Mgmt	power.ti.com	Optical Networking	www.ti.com/opticalnetwork
Microcontrollers	microcontroller.ti.com	Security	www.ti.com/security
RFID	www.ti-rfid.com	Telephony	www.ti.com/telephony
Low Power Wireless	www.ti.com/lpw	Video & Imaging	www.ti.com/video
		Wireless	www.ti.com/wireless

Mailing Address: Texas Instruments, Post Office Box 655303, Dallas, Texas 75265
Copyright © 2007, Texas Instruments Incorporated